

## 13-BIT 210 MSPS ANALOG-TO-DIGITAL CONVERTER

### FEATURES

- 13-Bit Resolution
- 210 MSPS Sample Rate
- SNR = 69 dBc at 100-MHz IF and 210 MSPS
- SFDR = 76 dBc at 100-MHz IF and 210 MSPS
- SNR = 68.1 dBc at 230-MHz IF and 210 MSPS
- SFDR = 74 dBc at 230-MHz IF and 210 MSPS
- 2.2 V<sub>pp</sub> Differential Input Voltage
- Fully Buffered Analog Inputs
- 5 V Analog Supply Voltage
- LVDS Compatible Outputs
- Total Power Dissipation: 2 W
- Offset Binary Output Format
- TQFP-80 PowerPAD™ Package
- Pin Compatible with the ADS5444
- Industrial Temperature Range = -40°C to 85°C

### APPLICATIONS

- Test and Measurement
- Software-Defined Radio
- Multi-channel Basestation Receivers
- Basestation Tx Digital Predistortion
- Communications Instrumentation

### RELATED PRODUCTS

- ADS5424 - 14-bit, 105 MSPS ADC
- ADS5423 - 14-bit, 80 MSPS ADC
- ADS5444 - 13-bit, 250 MSPS ADC

### DESCRIPTION

The ADS5440 is a 13-bit 210 MSPS analog-to-digital converter (ADC) that operates from a 5 V supply, while providing LVDS-compatible digital outputs from a 3.3 V supply. The ADS5440 input buffer isolates the internal switching of the onboard track and hold (T&H) from disturbing the signal source. An internal reference generator is also provided to further simplify the system design. The ADS5440 has outstanding low noise and linearity over input frequency.

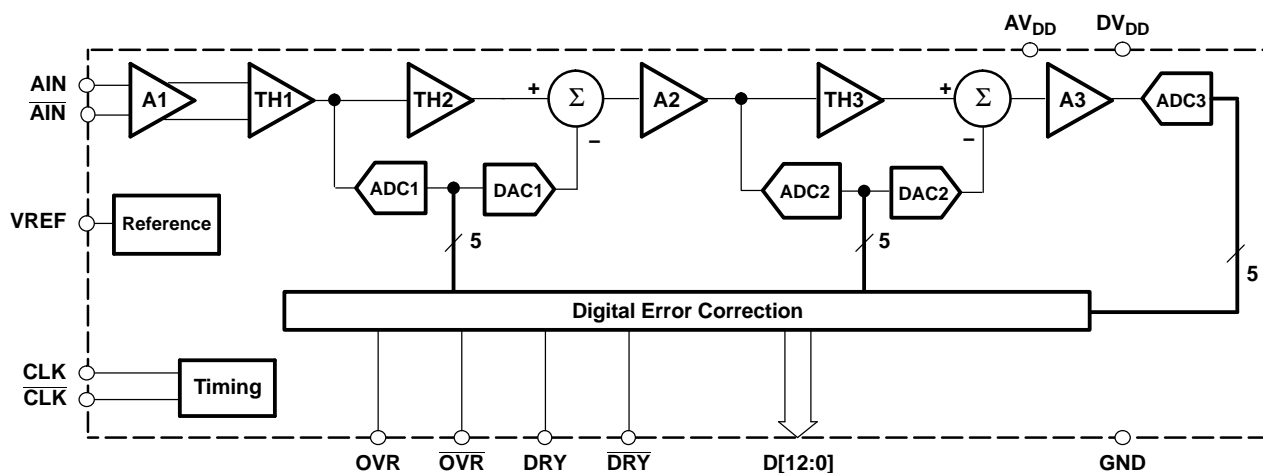

B0061-01

The ADS5440 is available in an 80-pin TQFP PowerPAD™ package. The ADS5440 is built on a state of the art Texas Instruments complementary bipolar process (BiCom3X) and is specified over the full industrial temperature range (-40°C to 85°C).



Please be aware that an important notice concerning availability, standard warranty, and use in critical applications of Texas Instruments semiconductor products and disclaimers thereto appears at the end of this data sheet.

PowerPAD is a trademark of Texas Instruments.



This integrated circuit can be damaged by ESD. Texas Instruments recommends that all integrated circuits be handled with appropriate precautions. Failure to observe proper handling and installation procedures can cause damage.

ESD damage can range from subtle performance degradation to complete device failure. Precision integrated circuits may be more susceptible to damage because very small parametric changes could cause the device not to meet its published specifications.

**PACKAGING/ORDERING INFORMATION<sup>(1)</sup>**

| Product | Package-Lead                        | Package Designator <sup>(1)</sup> | Specified Temperature Range | Package Marking | Ordering Number | Transport Media, Quantity |
|---------|-------------------------------------|-----------------------------------|-----------------------------|-----------------|-----------------|---------------------------|
| ADS5440 | HTQFP-80 <sup>(2)</sup><br>PowerPAD | PFP                               | –40°C to 85°C               | ADS5440IPFP     | ADS5440IPFP     | Tray, 96                  |
|         |                                     |                                   |                             |                 | ADS5440IPFPR    | Tape and Reel, 1000       |

(1) For the most current product and ordering information, see the Package Option Addendum located at the end of this data sheet.

(2) Thermal pad size: 7,5 mm x 7,5 mm (typ)

**ABSOLUTE MAXIMUM RATINGS**

over operating free-air temperature range (unless otherwise noted)<sup>(1)</sup>

|                                |                          | VALUE / UNIT                       |
|--------------------------------|--------------------------|------------------------------------|
| Supply voltage                 | AV <sub>DD</sub> to GND  | 6 V                                |
|                                | DRV <sub>DD</sub> to GND | 5 V                                |
| Analog input to GND            |                          | –0.3 V to AV <sub>DD</sub> +0.3 V  |
| Clock input to GND             |                          | –0.3 V to AV <sub>DD</sub> +0.3 V  |
| CLK to $\overline{\text{CLK}}$ |                          | ±2.5 V                             |
| Digital data output to GND     |                          | –0.3 V to DRV <sub>DD</sub> +0.3 V |
| Operating temperature range    |                          | –40°C to 85°C                      |
| Maximum junction temperature   |                          | 150°C                              |
| Storage temperature range      |                          | –65°C to 150°C                     |
| ESD Human Body Model (HBM)     |                          | 2.5 kV                             |

(1) Stresses above these ratings may cause permanent damage. Exposure to absolute maximum conditions for extended periods may degrade device reliability. These are stress ratings only and functional operation of the device at these or any other conditions beyond those specified is not implied.

**THERMAL CHARACTERISTICS<sup>(1)</sup>**

| PARAMETER     | TEST CONDITIONS                   | TYP  | UNIT |
|---------------|-----------------------------------|------|------|
| $\theta_{JA}$ | Soldered slug, no airflow         | 21.7 | °C/W |
|               | Soldered slug, 250-LFPM airflow   | 15.4 | °C/W |
|               | Unsoldered slug, no airflow       | 50   | °C/W |
|               | Unsoldered slug, 250-LFPM airflow | 43.4 | °C/W |
| $\theta_{JC}$ | Bottom of package (heatslug)      | 2.99 | °C/W |

(1) Using 36 thermal vias (6 x 6 array). See the Application Section.

**RECOMMENDED OPERATING CONDITIONS**

|                     |   | MIN  | NOM | MAX  | UNIT            |
|---------------------|---|------|-----|------|-----------------|
| <b>SUPPLIES</b>     |   |      |     |      |                 |
| $V_{DD}$            | Analog supply voltage                   | 4.75 | 5   | 5.25 | V               |
| $DRV_{DD}$          | Output driver supply voltage            | 3    | 3.3 | 3.6  | V               |
| <b>ANALOG INPUT</b> |   |      |     |      |                 |
|                     | Differential input range                |      | 2.2 |      | $V_{PP}$        |
| $V_{CM}$            | Input common mode                       |      | 2.4 |      | V               |
| <b>CLOCK INPUT</b>  |   |      |     |      |                 |
| $1/t_C$             | ADCLK input sample rate (sine wave)     | 10   |     | 210  | MSPS            |
|                     | Clock amplitude, differential sine wave |      | 3   |      | V <sub>pp</sub> |
|                     | Clock duty cycle                        |      | 50% |      |                 |
| $T_A$               | Open free air temperature               | -40  |     | 85   | °C              |

**ELECTRICAL CHARACTERISTICS**

MIN, TYP, and MAX values at  $T_A = 25^\circ\text{C}$ , full temperature range is  $T_{MIN} = -40^\circ\text{C}$  to  $T_{MAX} = 85^\circ\text{C}$ , sampling rate = 210 MSPS, 50% clock duty cycle,  $V_{DD} = 5\text{ V}$ ,  $DRV_{DD} = 3.3\text{ V}$ , -1 dBFS differential input, and 3  $V_{PP}$  differential clock, unless otherwise noted

| PARAMETER                                | TEST CONDITIONS  | MIN  | TYP       | MAX  | UNIT                      |
|--|--|------|-----------|------|---------------------------|
| Resolution                               |  |      | 13        |      | Bits                      |
| <b>ANALOG INPUTS</b>                     |  |      |           |      |                           |
| Differential input range                 |  |      | 2.2       |      | $V_{PP}$                  |
| Differential input resistance (DC)       |  |      | 1         |      | k $\Omega$                |
| Differential input capacitance           |  |      | 1.5       |      | pF                        |
| Analog input bandwidth                   |  |      | 800       |      | MHz                       |
| <b>INTERNAL REFERENCE VOLTAGE</b>        |  |      |           |      |                           |
| $V_{REF}$ Reference voltage              |  |      | 2.4       |      | V                         |
| <b>DYNAMIC ACCURACY</b>                  |  |      |           |      |                           |
| No missing codes                         |  |      | Assured   |      |                           |
| DNL Differential linearity error         | $f_{IN} = 10\text{ MHz}$   | -1   | $\pm 0.4$ | 1    | LSB                       |
| INL Integral linearity error             | $f_{IN} = 10\text{ MHz}$   | -2.2 | $\pm 0.9$ | 2.2  | LSB                       |
| Offset error                             |  | -11  |           | 11   | mV                        |
| Offset temperature coefficient           |  |      | 0.0005    |      | mV/°C                     |
| Gain error                               |  | -5   |           | 5    | %FS                       |
| Gain temperature coefficient             |  |      | -0.02     |      | $\Delta\%/^\circ\text{C}$ |
| PSRR                                     | 100-MHz supply frequency   |      | 1         |      | mV/V                      |
| <b>POWER SUPPLY</b>                      |  |      |           |      |                           |
| $I_{AVDD}$ Analog supply current         |  |      | 340       | 390  | mA                        |
| $I_{DRVDD}$ Output buffer supply current | $V_{IN} = \text{full scale}, f_{IN} = 100\text{ MHz}, F_S = 210\text{ MSPS}$ |      | 80        | 100  | mA                        |
| Power dissipation                        |  |      | 2         | 2.28 | W                         |

**ELECTRICAL CHARACTERISTICS (continued)**

MIN, TYP, and MAX values at  $T_A = 25^\circ\text{C}$ , full temperature range is  $T_{\text{MIN}} = -40^\circ\text{C}$  to  $T_{\text{MAX}} = 85^\circ\text{C}$ , sampling rate = 210 MSPS, 50% clock duty cycle,  $AV_{\text{DD}} = 5\text{ V}$ ,  $DRV_{\text{DD}} = 3.3\text{ V}$ ,  $-1\text{ dBFS}$  differential input, and  $3\text{ V}_{\text{PP}}$  differential clock, unless otherwise noted

| PARAMETER  |                             | TEST CONDITIONS                  |                          | MIN | TYP  | MAX  | UNIT |  |
|--|-----------------------------|----------------------------------|--------------------------|-----|------|------|------|--|
| <b>DYNAMIC AC CHARACTERISTICS</b>                  |                             |                                  |                          |     |      |      |      |  |
| SNR  | Signal-to-noise ratio       | $f_{\text{IN}} = 10\text{ MHz}$  |                          |     |      | 69.8 | dBc  |  |
|  |                             | $f_{\text{IN}} = 70\text{ MHz}$  |                          |     |      | 69.2 |      |  |
|  |                             | $f_{\text{IN}} = 100\text{ MHz}$ | $T_A = 25^\circ\text{C}$ |     | 67.5 | 69   |      |  |
|  |                             |                                  | Full Temp Range          |     | 67   | 69   |      |  |
|  |                             | $f_{\text{IN}} = 170\text{ MHz}$ |                          |     |      | 68.3 |      |  |
|  |                             | $f_{\text{IN}} = 230\text{ MHz}$ |                          |     |      | 68   |      |  |
|  |                             | $f_{\text{IN}} = 300\text{ MHz}$ |                          |     |      | 66.9 |      |  |
|  |                             | $f_{\text{IN}} = 400\text{ MHz}$ |                          |     |      | 65   |      |  |
| SFDR   | Spurious free dynamic range | $f_{\text{IN}} = 10\text{ MHz}$  |                          |     |      | 84   | dBc  |  |
|  |                             | $f_{\text{IN}} = 70\text{ MHz}$  |                          |     |      | 77   |      |  |
|  |                             | $f_{\text{IN}} = 100\text{ MHz}$ | $T_A = 25^\circ\text{C}$ |     | 70   | 76   |      |  |
|  |                             |                                  | Full Temp Range          |     | 68   | 76   |      |  |
|  |                             | $f_{\text{IN}} = 170\text{ MHz}$ |                          |     |      | 74   |      |  |
|  |                             | $f_{\text{IN}} = 230\text{ MHz}$ |                          |     |      | 74   |      |  |
|  |                             | $f_{\text{IN}} = 300\text{ MHz}$ |                          |     |      | 69   |      |  |
|  |                             | $f_{\text{IN}} = 400\text{ MHz}$ |                          |     |      | 64   |      |  |
| HD2  | Second harmonic             | $f_{\text{IN}} = 10\text{ MHz}$  |                          |     |      | 96   | dBc  |  |
|  |                             | $f_{\text{IN}} = 70\text{ MHz}$  |                          |     |      | 83   |      |  |
|  |                             | $f_{\text{IN}} = 100\text{ MHz}$ |                          |     |      | 87   |      |  |
|  |                             | $f_{\text{IN}} = 170\text{ MHz}$ |                          |     |      | 76   |      |  |
|  |                             | $f_{\text{IN}} = 230\text{ MHz}$ |                          |     |      | 76   |      |  |
|  |                             | $f_{\text{IN}} = 300\text{ MHz}$ |                          |     |      | 69   |      |  |
|  |                             | $f_{\text{IN}} = 400\text{ MHz}$ |                          |     |      | 64   |      |  |
| HD3  | Third harmonic              | $f_{\text{IN}} = 10\text{ MHz}$  |                          |     |      | 84   | dBc  |  |
|  |                             | $f_{\text{IN}} = 70\text{ MHz}$  |                          |     |      | 77   |      |  |
|  |                             | $f_{\text{IN}} = 100\text{ MHz}$ |                          |     |      | 76   |      |  |
|  |                             | $f_{\text{IN}} = 170\text{ MHz}$ |                          |     |      | 74   |      |  |
|  |                             | $f_{\text{IN}} = 230\text{ MHz}$ |                          |     |      | 74   |      |  |
|  |                             | $f_{\text{IN}} = 300\text{ MHz}$ |                          |     |      | 73   |      |  |
|  |                             | $f_{\text{IN}} = 400\text{ MHz}$ |                          |     |      | 70   |      |  |
| Worst other harmonic/spur (other than HD2 and HD3) |                             | $f_{\text{IN}} = 10\text{ MHz}$  |                          |     |      | 92   | dBc  |  |
|  |                             | $f_{\text{IN}} = 70\text{ MHz}$  |                          |     |      | 92   |      |  |
|  |                             | $f_{\text{IN}} = 100\text{ MHz}$ |                          |     |      | 87   |      |  |
|  |                             | $f_{\text{IN}} = 170\text{ MHz}$ |                          |     |      | 87   |      |  |
|  |                             | $f_{\text{IN}} = 230\text{ MHz}$ |                          |     |      | 83   |      |  |
|  |                             | $f_{\text{IN}} = 300\text{ MHz}$ |                          |     |      | 83   |      |  |
|  |                             | $f_{\text{IN}} = 400\text{ MHz}$ |                          |     |      | 80   |      |  |

**ELECTRICAL CHARACTERISTICS (continued)**

MIN, TYP, and MAX values at  $T_A = 25^\circ\text{C}$ , full temperature range is  $T_{\text{MIN}} = -40^\circ\text{C}$  to  $T_{\text{MAX}} = 85^\circ\text{C}$ , sampling rate = 210 MSPS, 50% clock duty cycle,  $AV_{\text{DD}} = 5\text{ V}$ ,  $DRV_{\text{DD}} = 3.3\text{ V}$ ,  $-1\text{ dBFS}$  differential input, and  $3\text{ V}_{\text{PP}}$  differential clock, unless otherwise noted

| PARAMETER   |                             | TEST CONDITIONS                  | MIN   | TYP  | MAX   | UNIT |
|---|-----------------------------|----------------------------------|-------|------|-------|------|
| SINAD   |                             | $f_{\text{IN}} = 10\text{ MHz}$  |       | 69.6 |       | dBc  |
|   |                             | $f_{\text{IN}} = 70\text{ MHz}$  |       | 68.8 |       |      |
|   |                             | $f_{\text{IN}} = 100\text{ MHz}$ |       | 68   |       |      |
|   |                             | $f_{\text{IN}} = 170\text{ MHz}$ |       | 66.8 |       |      |
|   |                             | $f_{\text{IN}} = 230\text{ MHz}$ |       | 66   |       |      |
|   |                             | $f_{\text{IN}} = 300\text{ MHz}$ |       | 64   |       |      |
|   |                             | $f_{\text{IN}} = 400\text{ MHz}$ |       | 60   |       |      |
| ENOB  | Effective number of bits    | $f_{\text{IN}} = 10\text{ MHz}$  |       | 11.4 |       | Bits |
|   | RMS idle channel noise      | Inputs tied to common-mode       |       | 0.4  |       | LSB  |
| <b>DIGITAL CHARACTERISTICS – LVDS DIGITAL OUTPUTS</b> |                             |                                  |       |      |       |      |
|   | Differential output voltage |                                  | 0.247 |      | 0.452 | V    |
|   | Output offset voltage       |                                  | 1.125 | 1.25 | 1.375 | V    |

**TIMING CHARACTERISTICS**

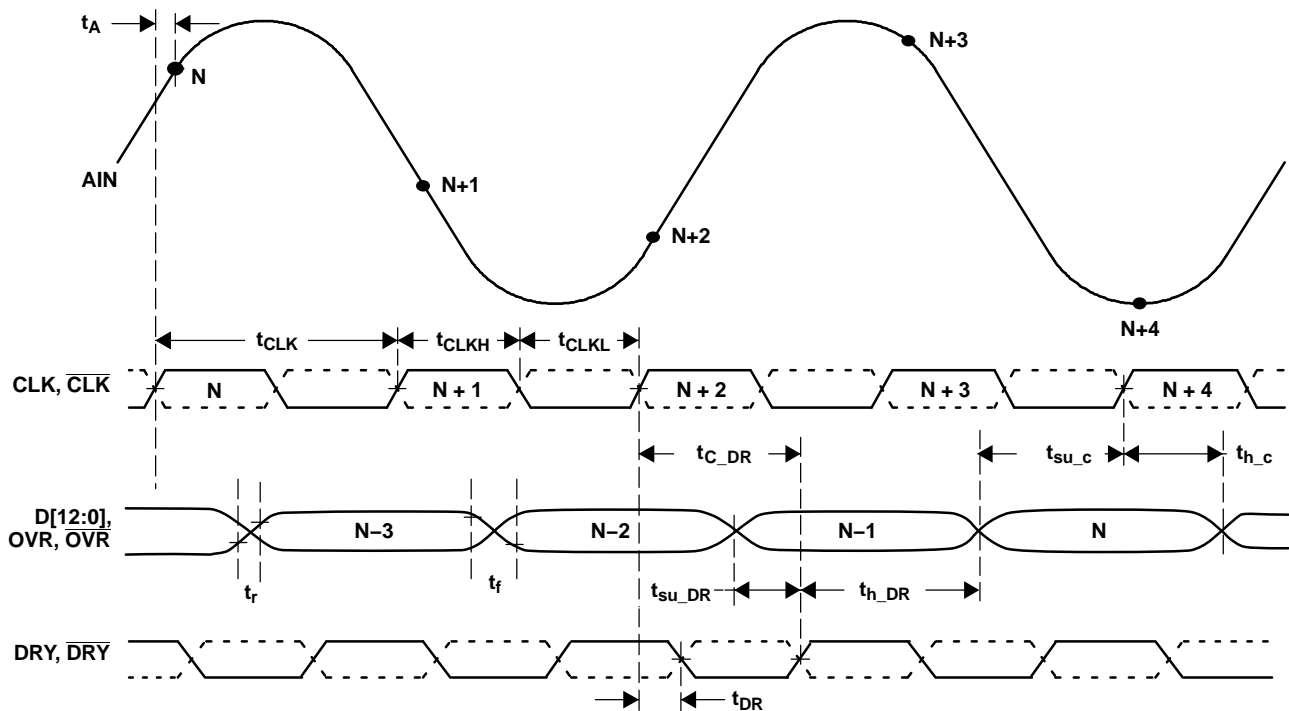

T0073-01

**Figure 1. Timing Diagram**

**TIMING CHARACTERISTICS**

Min, Typ, Max over full temperature range, 50% clock duty cycle, sampling rate = 210 MSPS,  $A_{V_{DD}} = 5 \text{ V}$ ,  $DRV_{DD} = 3.3 \text{ V}$

| PARAMETER                                       |   | TEST CONDITIONS                       | MIN | TYP  | MAX | UNIT   |
|---|---|---------------------------------------|-----|------|-----|--------|
| $t_A$   | Aperture delay  |                                       |     | 500  |     | ps     |
| $t_J$   | Clock slope independent aperture uncertainty (jitter) |                                       |     | 150  |     | fs RMS |
|   | Latency   |                                       |     | 4    |     | cycles |
| <b>Clock Input</b>                              |   |                                       |     |      |     |        |
| $t_{\text{CLK}}$                                | Clock period  |                                       |     | 4.76 |     | ns     |
| $t_{\text{CLKH}}$                               | Clock pulsewidth high                                 |                                       |     | 2.38 |     | ns     |
| $t_{\text{CLKL}}$                               | Clock pulsewidth low                                  |                                       |     | 2.38 |     | ns     |
| <b>Clock to DataReady (DRY)</b>                 |   |                                       |     |      |     |        |
| $t_{\text{DR}}$                                 | Clock rising to DataReady falling                     |                                       |     | 1.1  |     | ns     |
| $t_{\text{C}_\text{DR}}$                        | Clock rising to DataReady rising                      | Clock duty cycle = 50% <sup>(1)</sup> | 3.1 | 3.5  | 3.9 | ns     |
| <b>Clock to DATA, OVR <sup>(2)</sup></b>        |   |                                       |     |      |     |        |
| $t_r$   | Data rise time (20% to 80%)                           |                                       |     | 0.6  |     | ns     |
| $t_f$   | Data fall time(80% to 20%)                            |                                       |     | 0.6  |     | ns     |
| $t_{\text{SU}_C}$                               | Data valid to clock (setup time)                      |                                       |     | 3.5  |     | ns     |
| $t_{\text{H}_C}$                                | Clock to invalid Data (hold time)                     |                                       |     | 0.2  |     | ns     |
| <b>DataReady (DRY)/DATA, OVR <sup>(2)</sup></b> |   |                                       |     |      |     |        |
| $t_{\text{SU}_\text{DR}}$                       | Data valid to DRY                                     |                                       | 2.1 | 2.4  |     | ns     |
| $t_{\text{H}_\text{DR}}$                        | DRY to invalid Data                                   |                                       | 0.9 | 1.3  |     | ns     |

(1)  $t_{\text{C}_\text{DR}} = t_{\text{DR}} + t_{\text{CLKH}}$  for clock duty cycles other than 50%  
 (2) Data is updated with clock falling edge or DRY rising edge.

**DEVICE INFORMATION**

**PFP PACKAGE  
(TOP VIEW)**

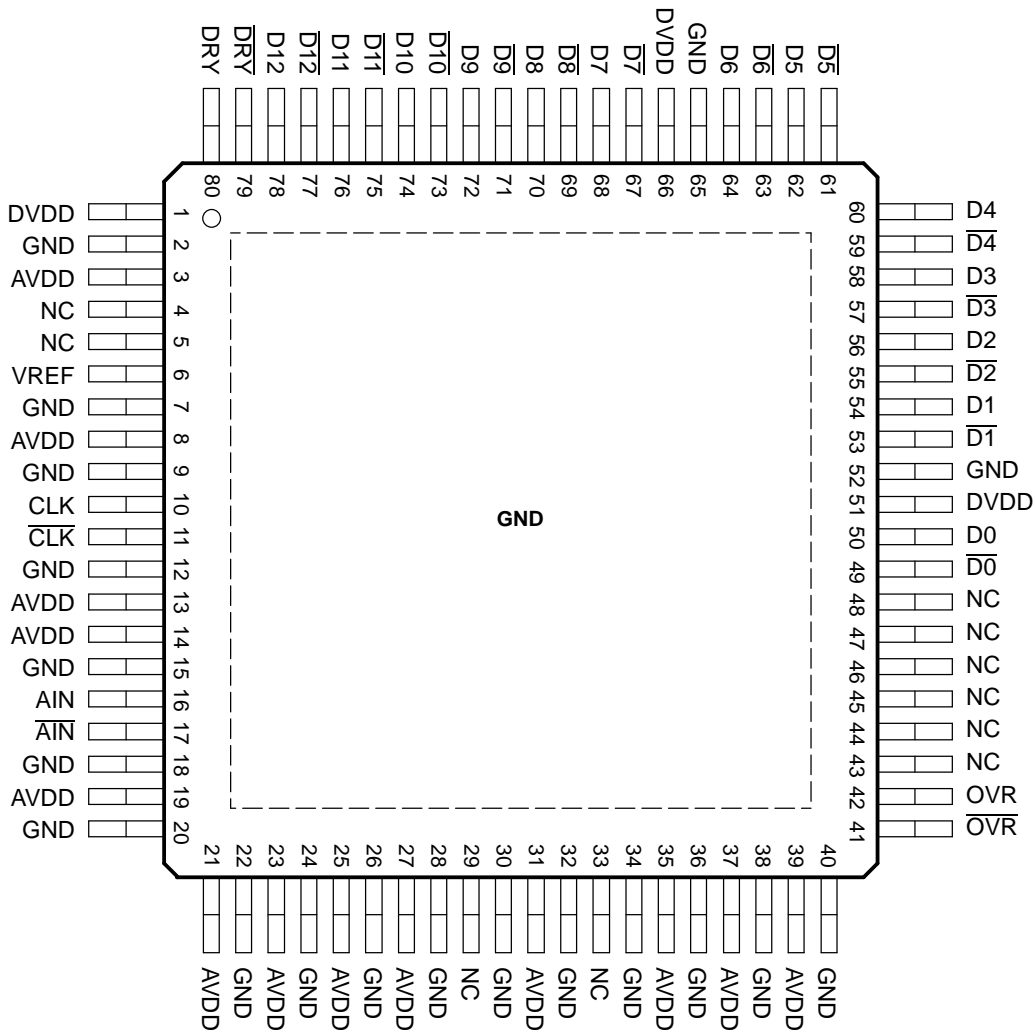

P0027-01

**TERMINAL FUNCTIONS**

| TERMINAL                |   | DESCRIPTION  |
|-------------------------|---|--|
| NAME                    | NO.   |  |
| AVDD                    | 3, 8, 13, 14, 19, 21, 23, 25, 27, 31, 35, 37, 39                        | Analog power supply  |
| DVDD                    | 1, 51, 66   | Output driver power supply   |
| GND                     | 2, 7, 9, 12, 15, 18, 20, 22, 24, 26, 28, 30, 32, 34, 36, 38, 40, 52, 65 | Ground   |
| VREF                    | 6   | Reference voltage  |
| CLK                     | 10  | Differential input clock (positive). Conversion initiated on rising edge |
| $\overline{\text{CLK}}$ | 11  | Differential input clock (negative)                                      |
| AIN                     | 16  | Differential input signal (positive)                                     |
| $\overline{\text{AIN}}$ | 17  | Differential input signal (negative)                                     |

**DEVICE INFORMATION (continued)**  
**TERMINAL FUNCTIONS (continued)**

| TERMINAL   |                     | DESCRIPTION   |
|--|---------------------|---|
| NAME   | NO.                 |   |
| OVR, $\overline{\text{OVR}}$                                 | 42, 41              | Over range indicator LVDS output. A logic high signals an analog input in excess of the full-scale range. |
| D0, $\overline{\text{D0}}$                                   | 50, 49              | LVDS digital output pair, least-significant bit (LSB)   |
| D1–D6, $\overline{\text{D1}}\text{--}\overline{\text{D6}}$   | 53–64               | LVDS digital output pairs   |
| D7–D11, $\overline{\text{D7}}\text{--}\overline{\text{D11}}$ | 67–76               | LVDS digital output pairs   |
| D12, $\overline{\text{D12}}$                                 | 78, 77              | LVDS digital output pair, most-significant bit (MSB)  |
| DRY, $\overline{\text{DRY}}$                                 | 80, 79              | Data ready LVDS output pair   |
| NC   | 4, 5, 29, 33, 43–48 | No connect  |

**DEFINITION OF SPECIFICATIONS**

**Analog Bandwidth** The analog input frequency at which the power of the fundamental is reduced by 3 dB with respect to the low frequency value.

**Aperture Delay** The delay in time between the rising edge of the input sampling clock and the actual time at which the sampling occurs.

**Aperture Uncertainty (Jitter)** The sample-to-sample variation in aperture delay.

**Clock Pulse Width/Duty Cycle** The duty cycle of a clock signal is the ratio of the time the clock signal remains at a logic high (clock pulse width) to the period of the clock signal. Duty cycle is typically expressed as a percentage. A perfect differential sine wave clock results in a 50% duty cycle.

**Maximum Conversion Rate** The maximum sampling rate at which certified operation is given. All parametric testing is performed at this sampling rate unless otherwise noted.

**Minimum Conversion Rate** The minimum sampling rate at which the ADC functions.

**Differential Nonlinearity (DNL)** An ideal ADC exhibits code transitions at analog input values spaced exactly 1 LSB apart. The DNL is the deviation of any single step from this ideal value, measured in units of LSB.

**Integral Nonlinearity (INL)** The INL is the deviation of the ADCs transfer function from a best fit line determined by a least squares curve fit of that transfer function. The INL at each analog input value is the difference between the actual transfer function and this best fit line, measured in units of LSB.

**Gain Error** The gain error is the deviation of the ADCs actual input full-scale range from its ideal value. The gain error is given as a percentage of the ideal input full-scale range.

**Offset Error** Offset error is the deviation of output code from mid-code when both inputs are tied to common-mode.

**Temperature Drift** Temperature drift (with respect to gain error and offset error) specifies the change from the value at the nominal temperature to the value at  $T_{\text{MIN}}$  or  $T_{\text{MAX}}$ . It is computed as the maximum variation the parameters over the whole temperature range divided by  $T_{\text{MIN}} - T_{\text{MAX}}$ .

**Signal-to-Noise Ratio (SNR)** SNR is the ratio of the power of the fundamental ( $P_S$ ) to the noise floor power ( $P_N$ ), excluding the power at dc and the first five harmonics.

$$\text{SNR} = 10 \log_{10} \frac{P_S}{P_N} \tag{1}$$

SNR is either given in units of dBc (dB to carrier) when the absolute power of the fundamental is used as the reference, or dBFS (dB to full scale) when the power of the fundamental is extrapolated to the converter's full-scale range.

**Signal-to-Noise and Distortion (SINAD)** SINAD is the ratio of the power of the fundamental ( $P_S$ ) to the power of all the other spectral components including noise ( $P_N$ ) and distortion ( $P_D$ ), but excluding dc.

$$\text{SINAD} = 10 \log_{10} \frac{P_S}{P_N + P_D} \tag{2}$$

SINAD is either given in units of dBc (dB to carrier) when the absolute power of the fundamental is used as the reference, or dBFS (dB to full scale) when the power of the fundamental is extrapolated to the converter's full-scale range.

---

### DEFINITION OF SPECIFICATIONS (continued)

**Effective Resolution Bandwidth** The highest input frequency where the SNR (dB) is dropped by 3 dB for a full-scale input amplitude.

**Total Harmonic Distortion (THD)** THD is the ratio of the power of the fundamental ( $P_S$ ) to the power of the first five harmonics ( $P_D$ ).

$$\text{THD} = 10 \log_{10} \frac{P_S}{P_D} \quad (3)$$

THD is typically given in units of dBc (dB to carrier).

**Two-Tone Intermodulation Distortion** IMD3 is the ratio of the power of the fundamental (at frequencies  $f_1, f_2$ ) to the power of the worst spectral component at either frequency  $2f_1 - f_2$  or  $2f_2 - f_1$ . IMD3 is either given in units of dBc (dB to carrier) when the absolute power of the fundamental is used as the reference or dBFS (dB to full scale) when the power of the fundamental is extrapolated to the converter's full-scale range.

TYPICAL CHARACTERISTICS

Spectral Performance  
(FFT For 10-MHz Input Signal)

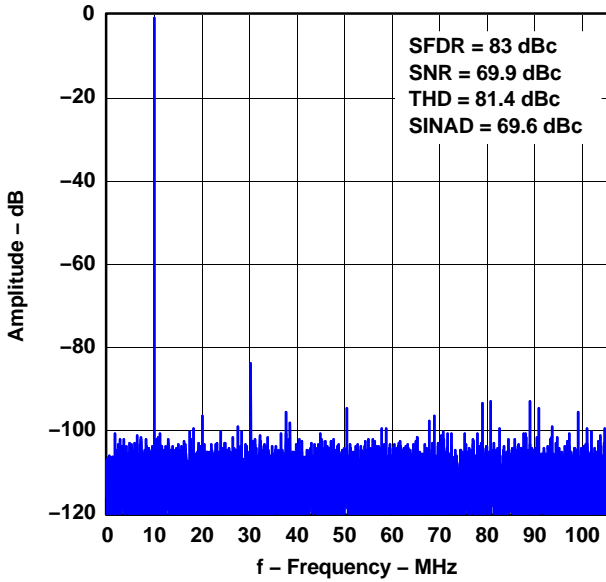

G001

Figure 2.

Spectral Performance  
(FFT For 100-MHz Input Signal)

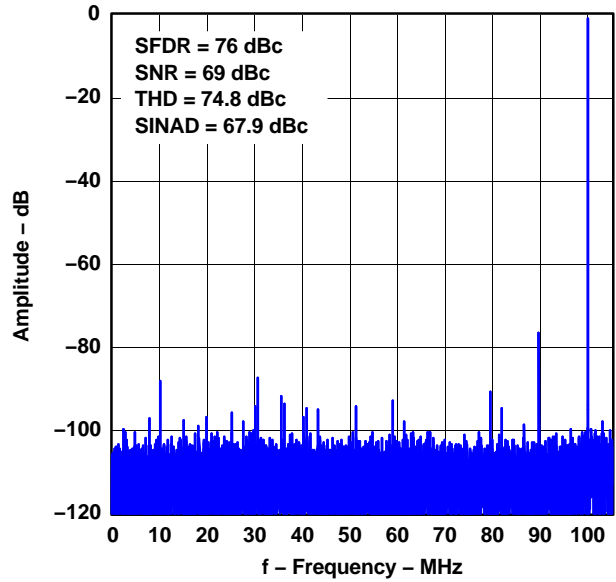

G002

Figure 3.

Spectral Performance  
(FFT For 170-MHz Input Signal)

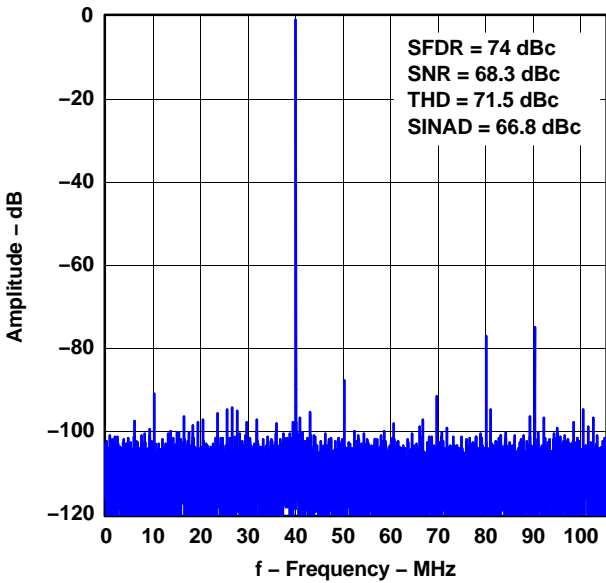

G003

Figure 4.

Spectral Performance  
(FFT For 230-MHz Input Signal)

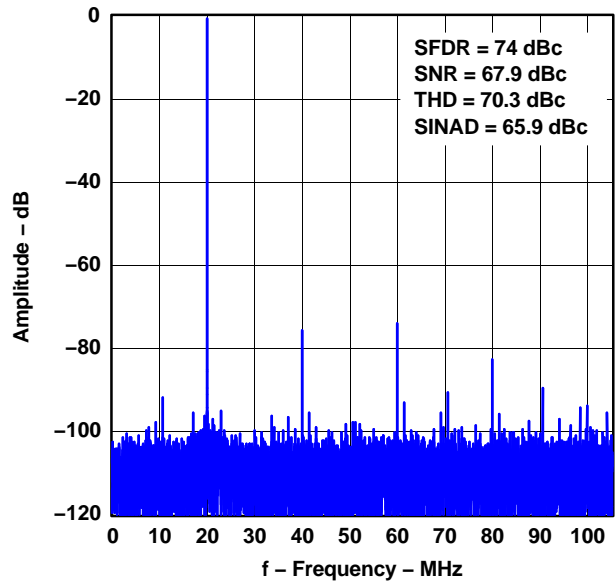

G004

Figure 5.

**TYPICAL CHARACTERISTICS (continued)**

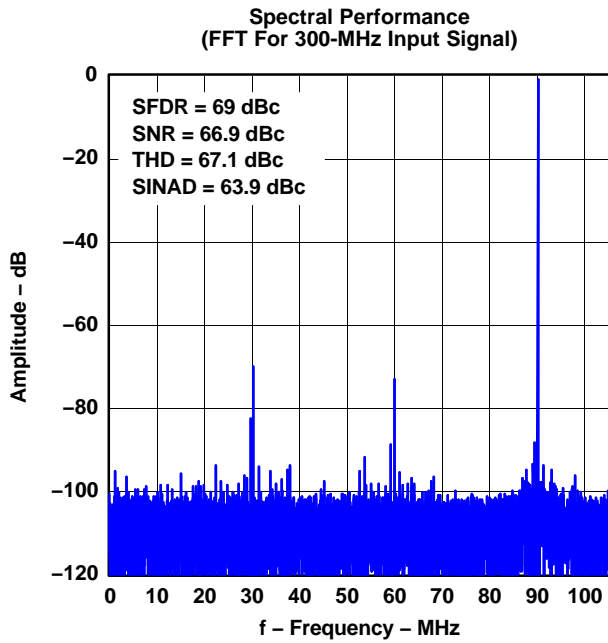

G005

Figure 6.

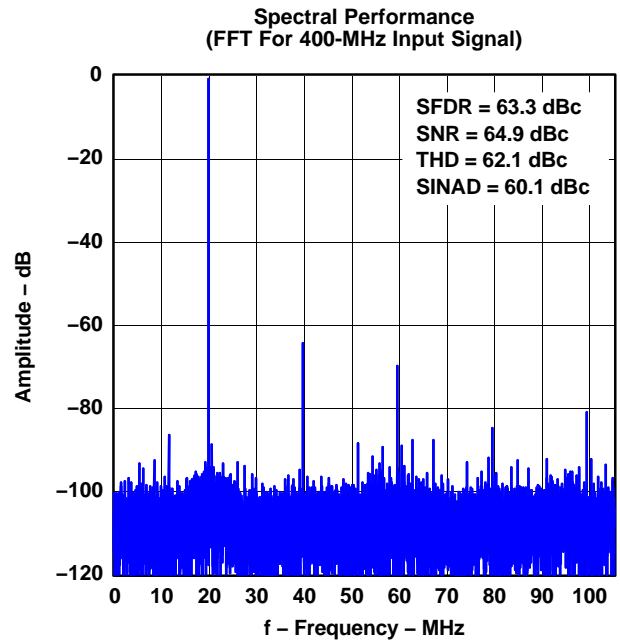

G006

Figure 7.

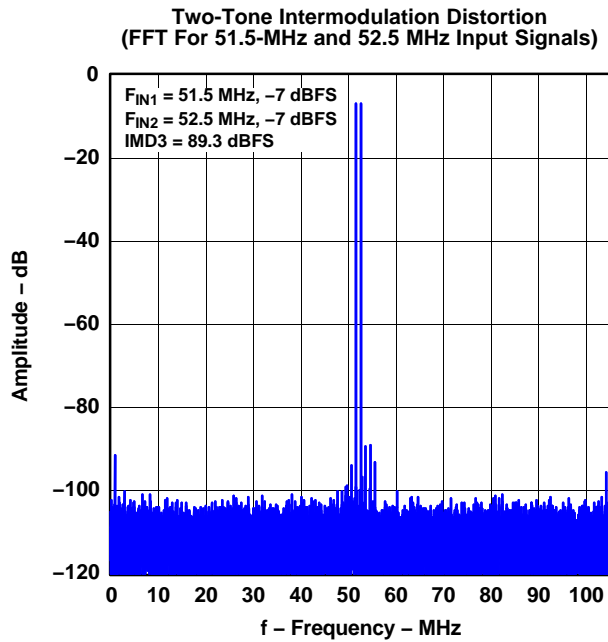

G007

Figure 8.

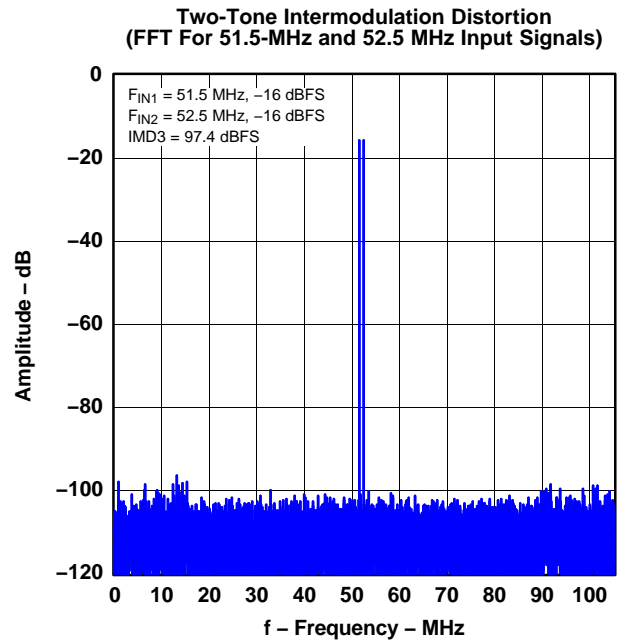

G008

Figure 9.

TYPICAL CHARACTERISTICS (continued)

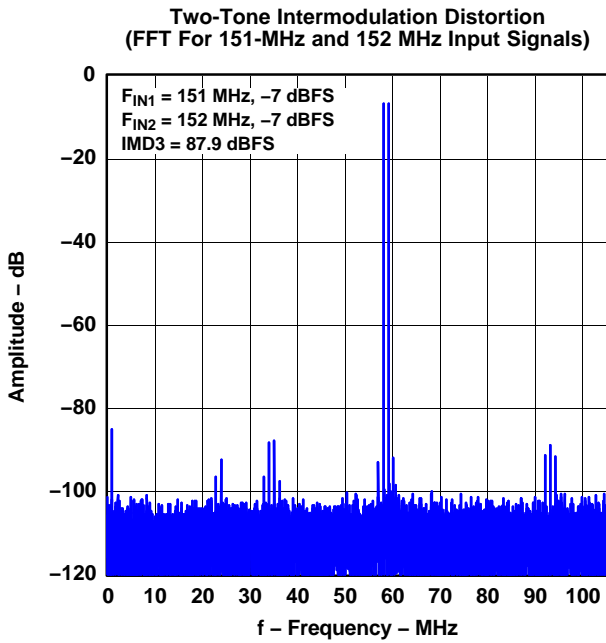

G009

Figure 10.

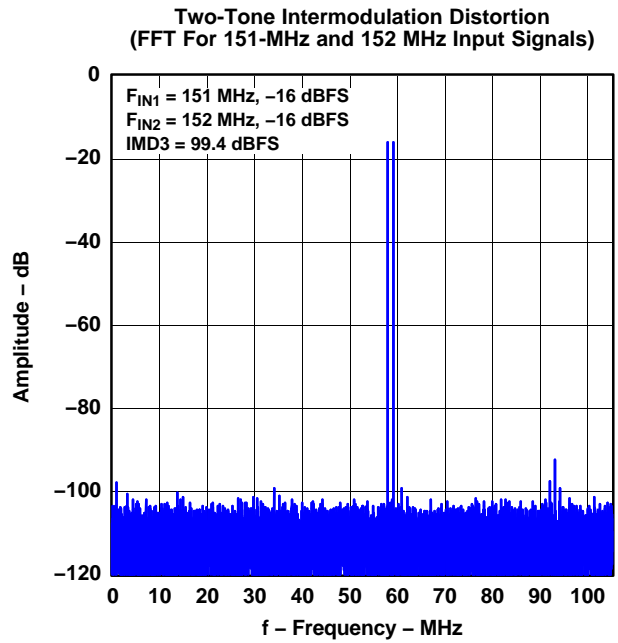

G010

Figure 11.

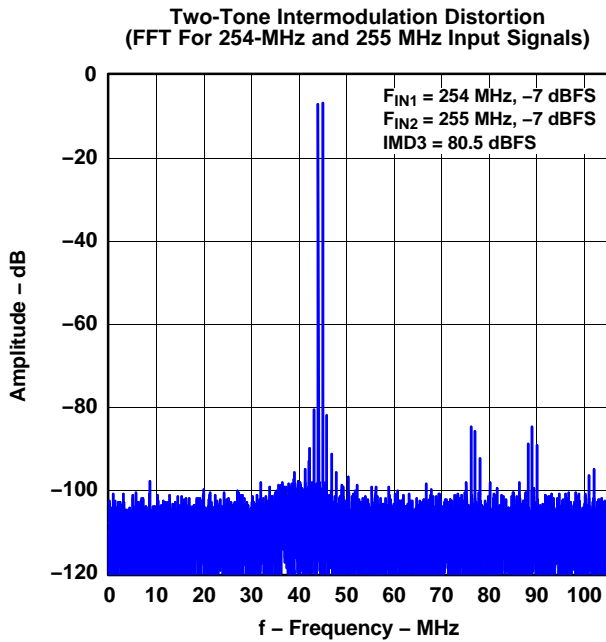

G011

Figure 12.

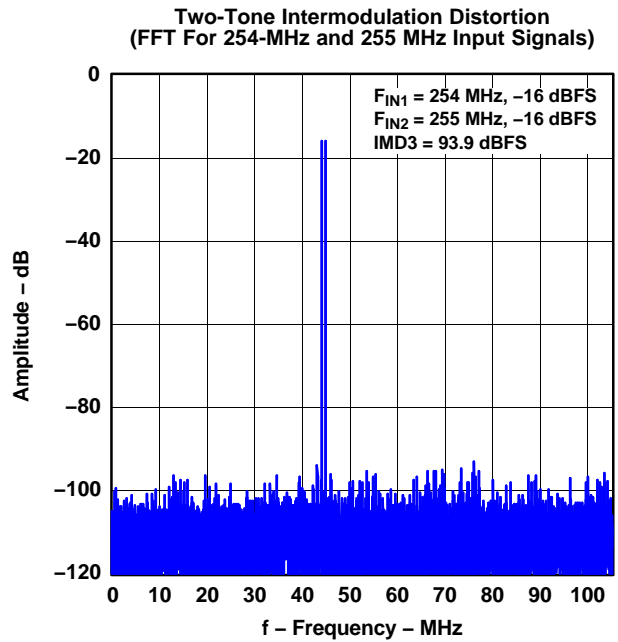

G012

Figure 13.

**TYPICAL CHARACTERISTICS (continued)**

**Two-Tone Intermodulation Distortion  
(FFT For 355-MHz and 356 MHz Input Signals)**

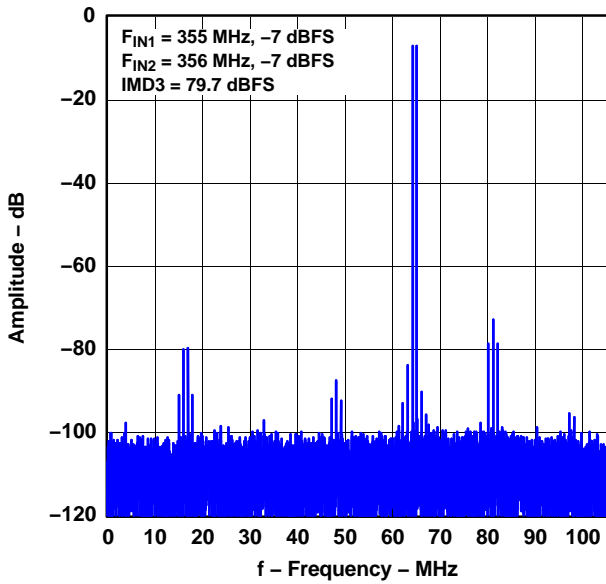

G013

**Figure 14.**

**Two-Tone Intermodulation Distortion  
(FFT For 355-MHz and 356 MHz Input Signals)**

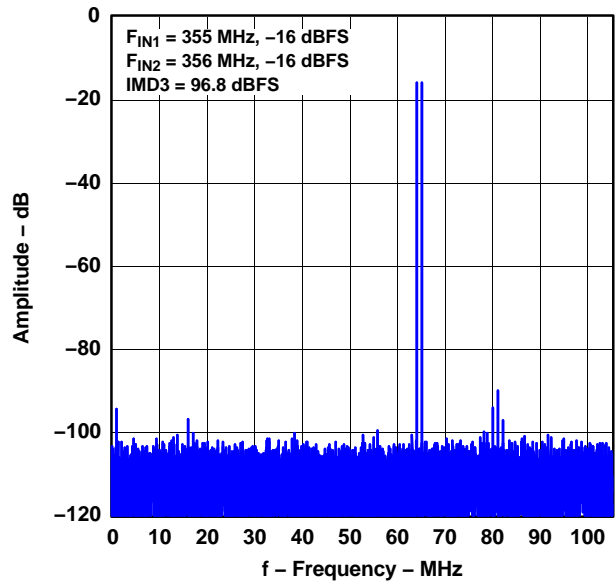

G014

**Figure 15.**

**WCDMA Carrier  
( $f_{IN} = 70$  MHz)**

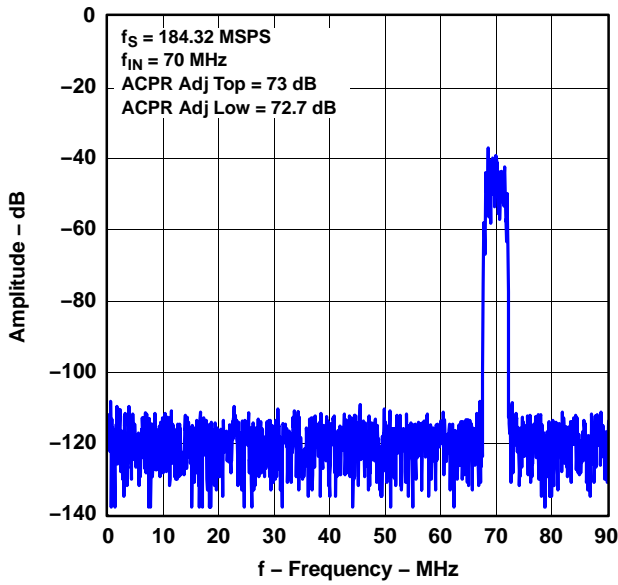

G015

**Figure 16.**

**WCDMA Carrier  
( $f_{IN} = 140$  MHz)**

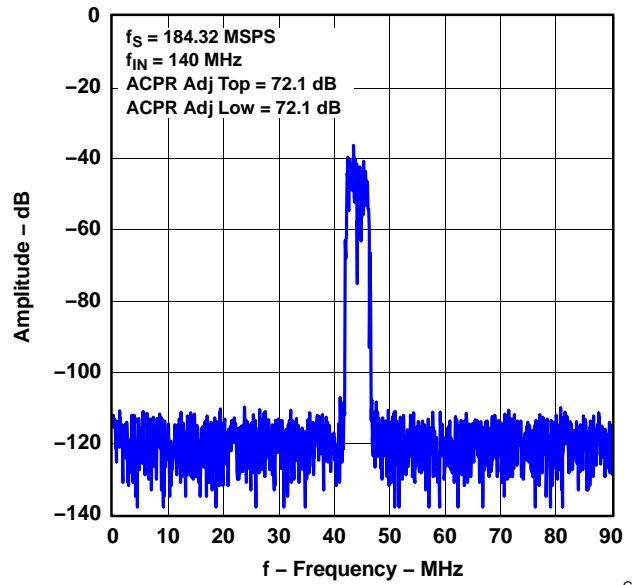

G016

**Figure 17.**

TYPICAL CHARACTERISTICS (continued)

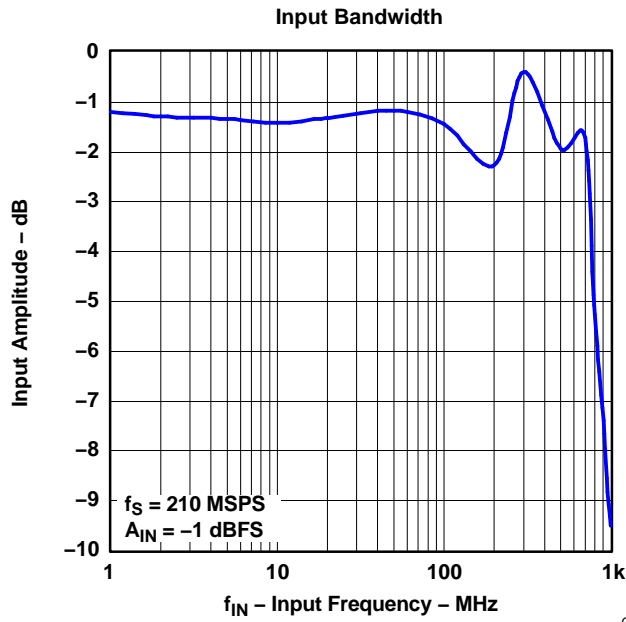

Figure 18.

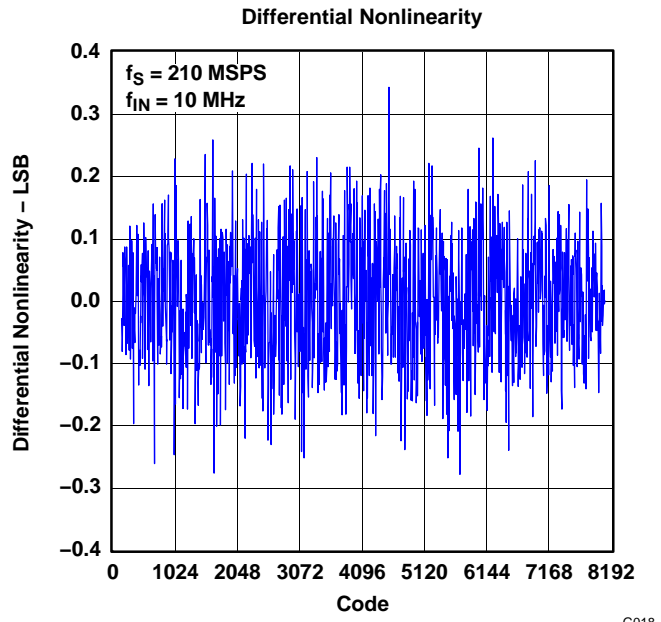

Figure 19.

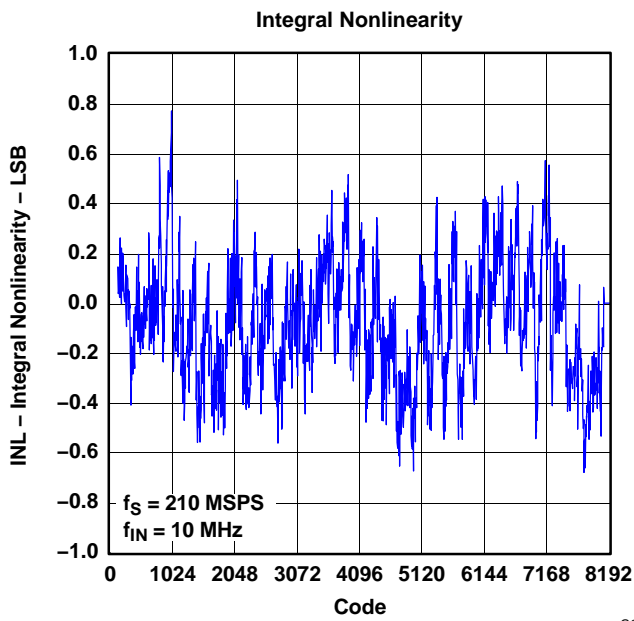

Figure 20.

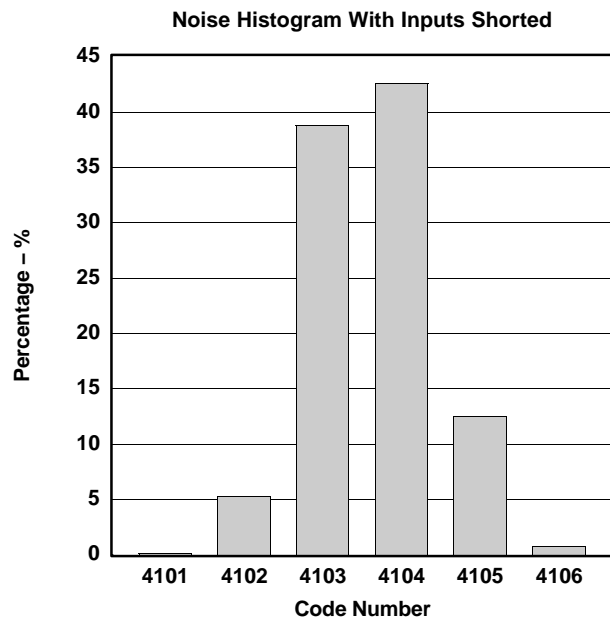

Figure 21.

TYPICAL CHARACTERISTICS (continued)

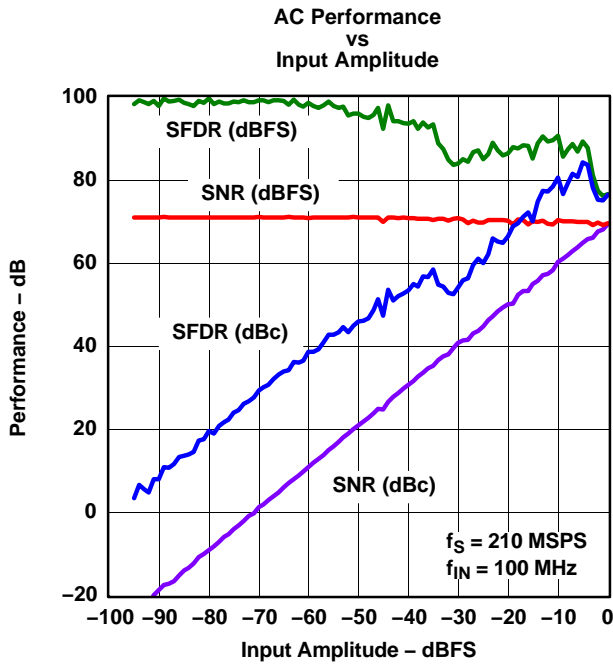

Figure 22.

G021

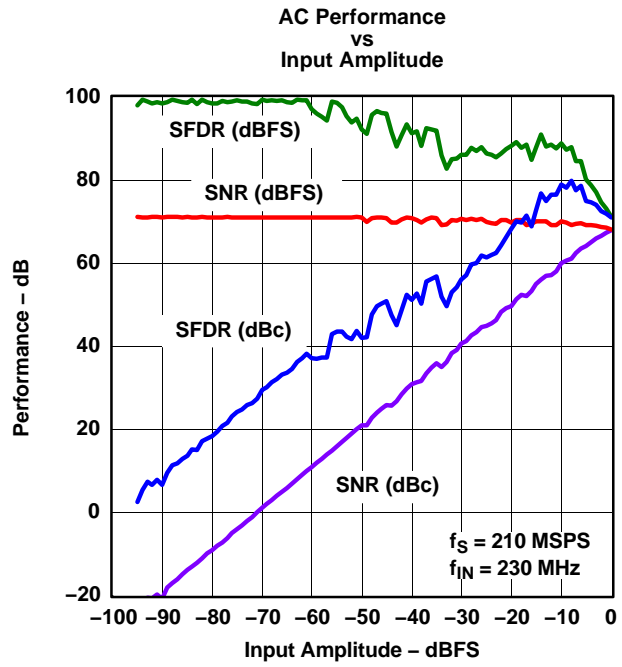

Figure 23.

G022

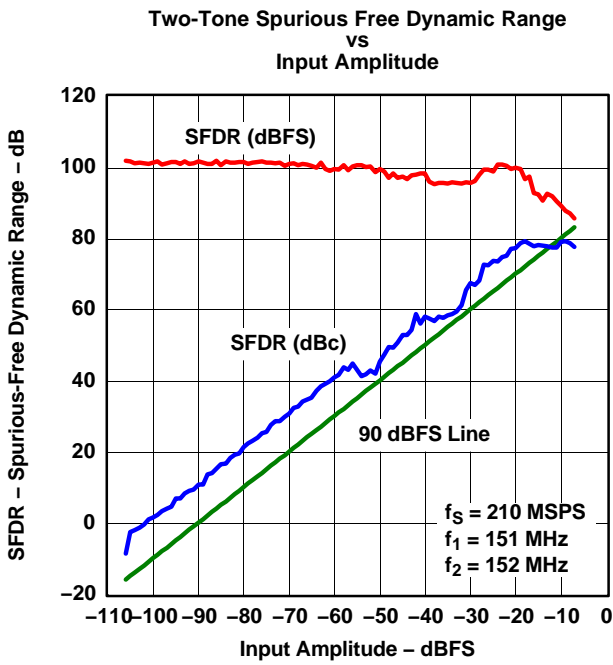

Figure 24.

G023

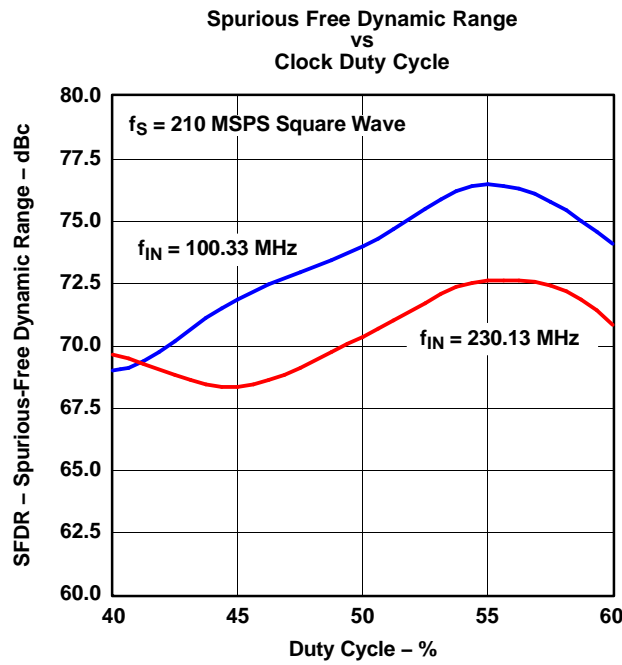

Figure 25.

G024

TYPICAL CHARACTERISTICS (continued)

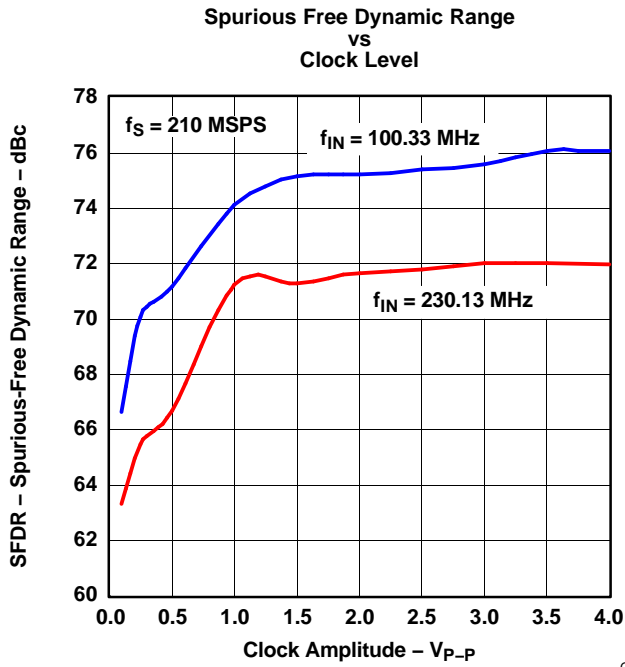

Figure 26.

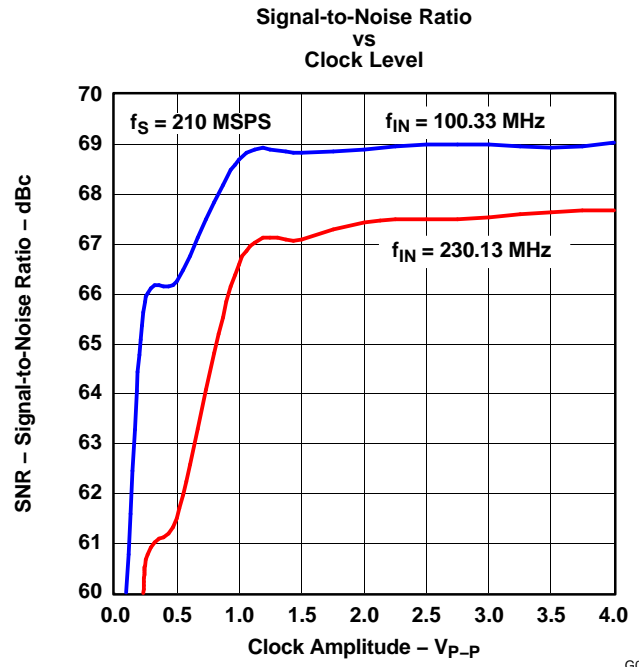

Figure 27.

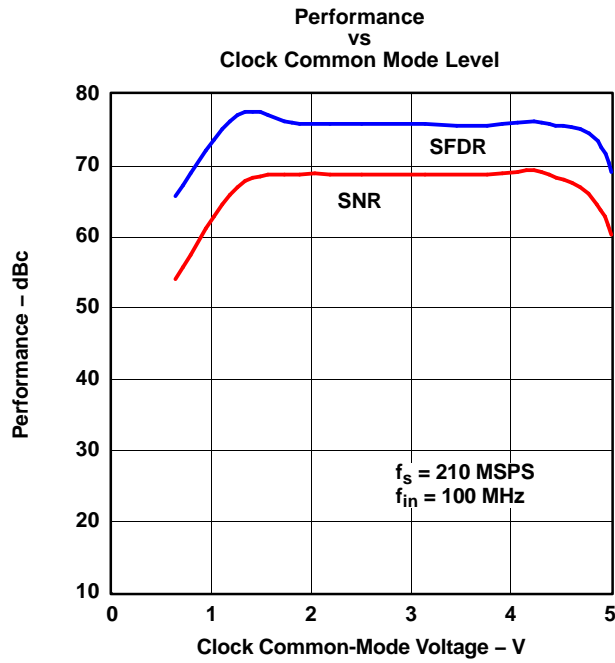

Figure 28.

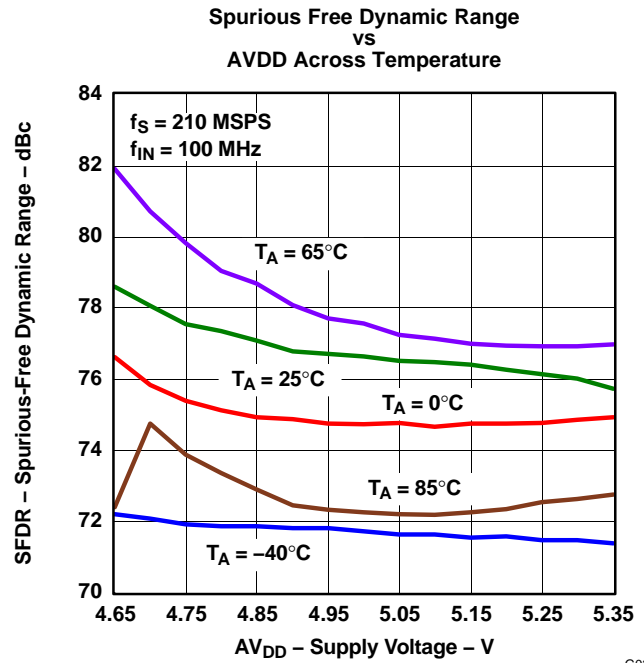

Figure 29.

TYPICAL CHARACTERISTICS (continued)

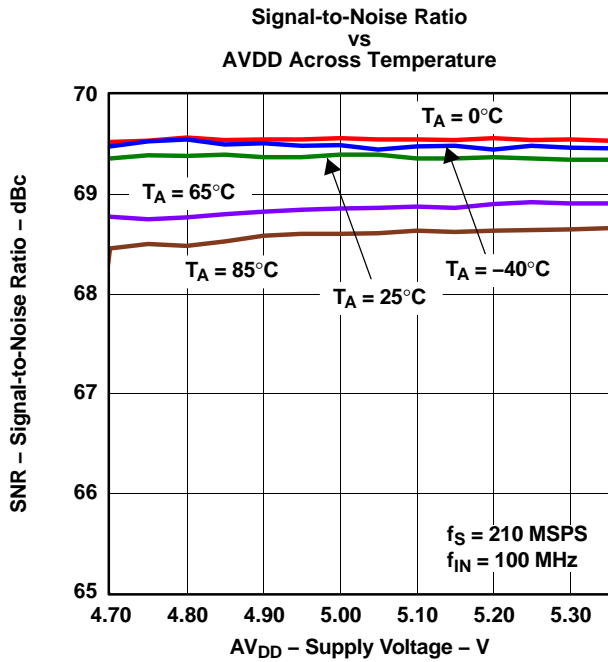

Figure 30.

G029

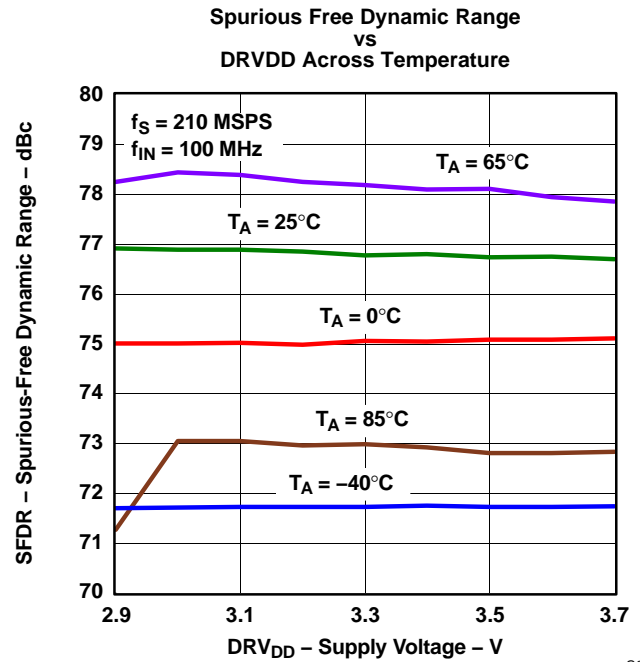

Figure 31.

G030

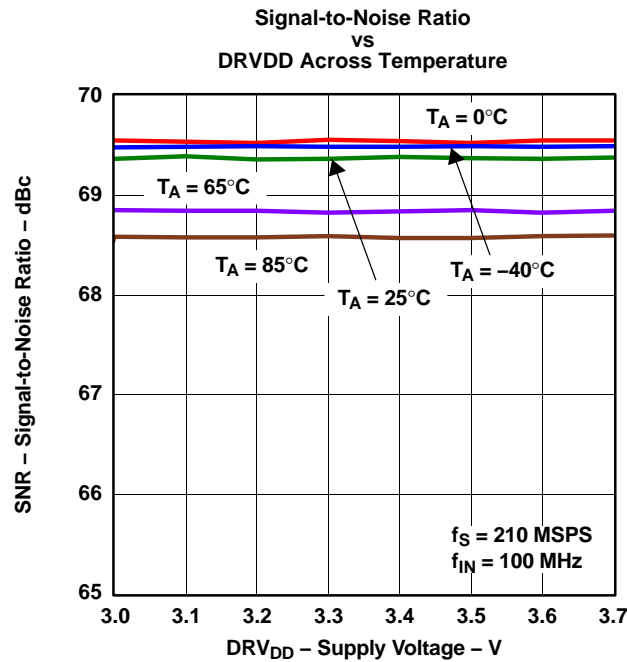
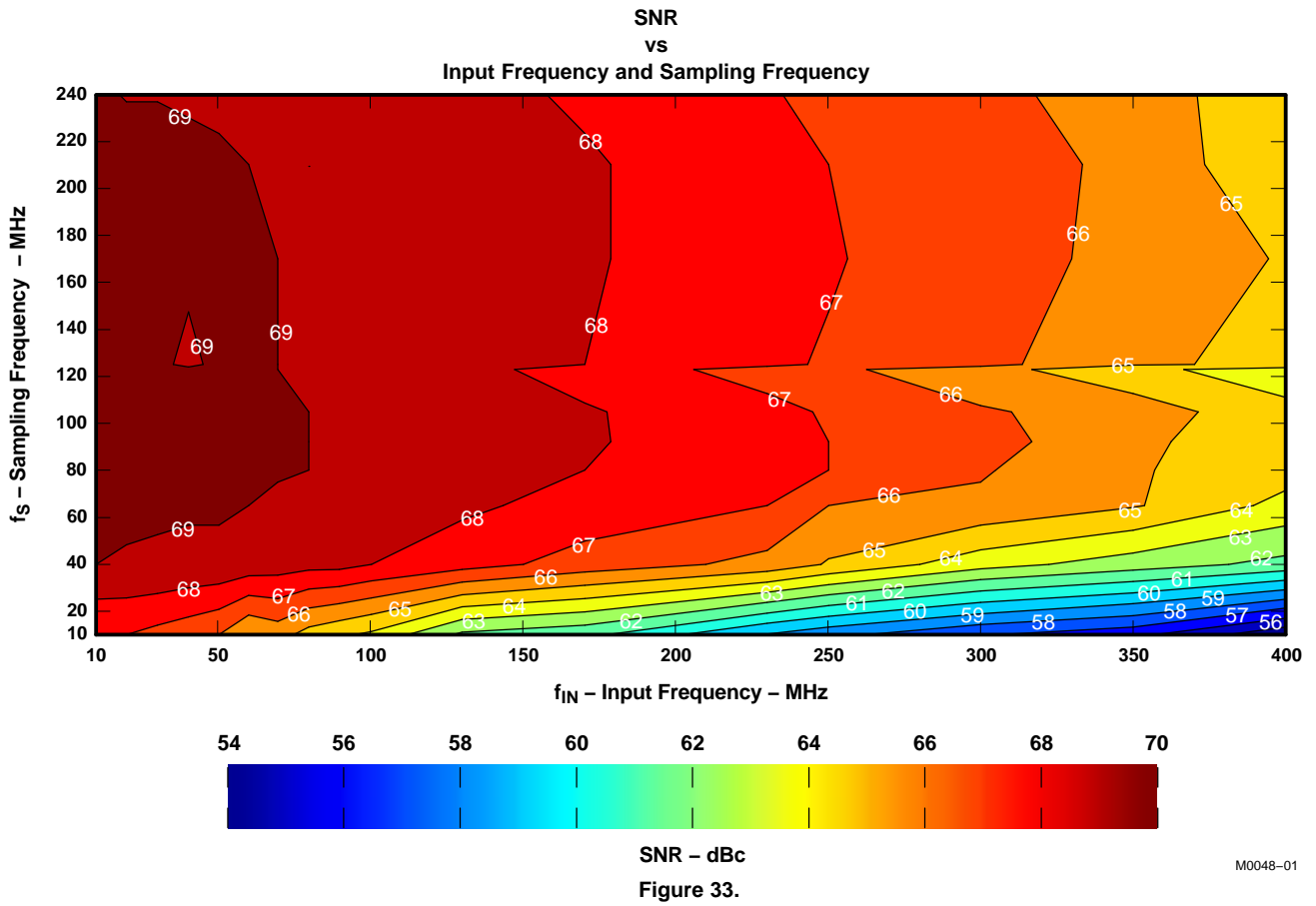

Figure 32.

G031

### TYPICAL CHARACTERISTICS (continued)



**TYPICAL CHARACTERISTICS (continued)**

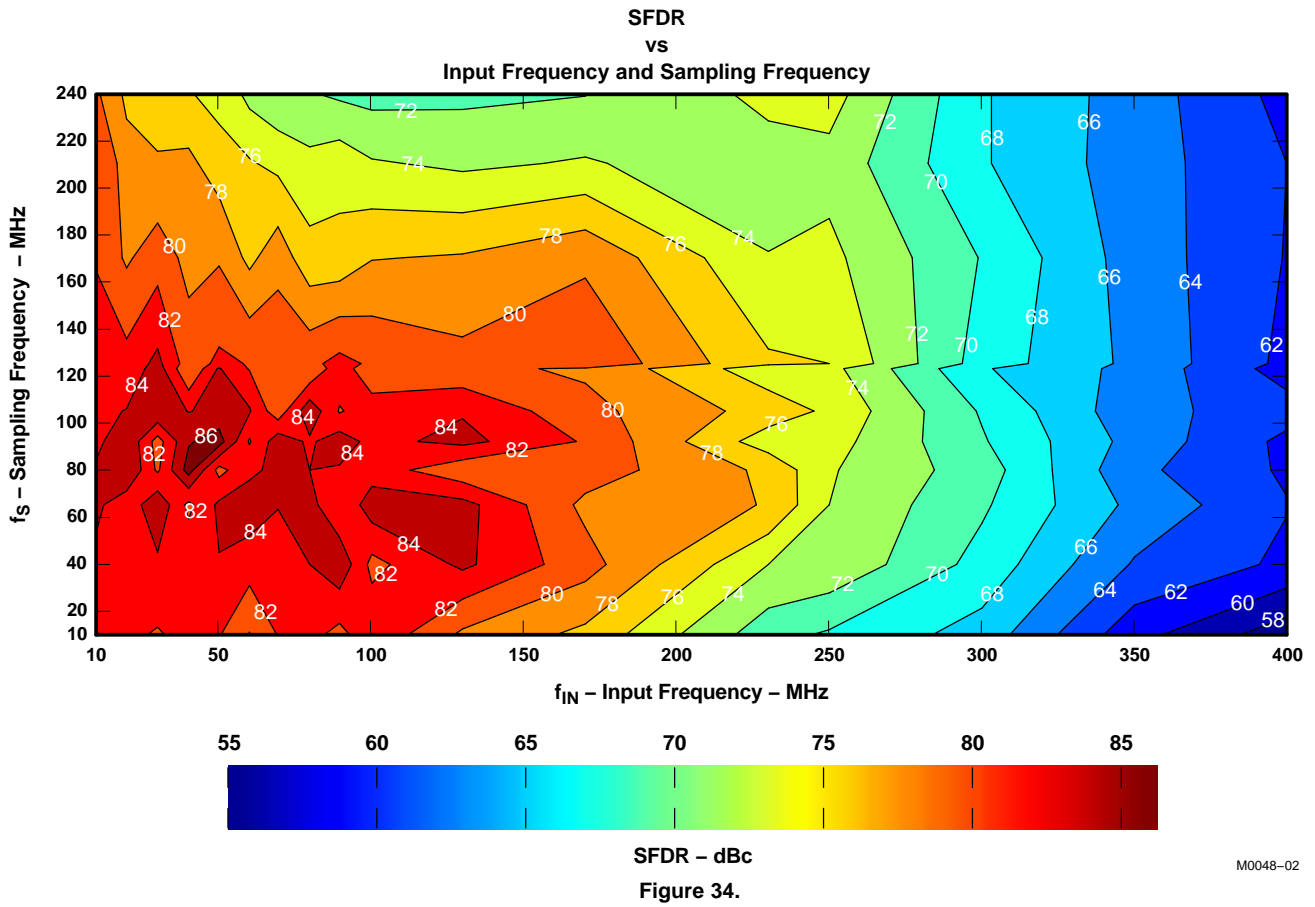

## APPLICATION INFORMATION

### Theory of Operation

The ADS5440 is a 13 bit, 210 MSPS, monolithic pipeline analog to digital converter. Its bipolar analog core operates from a 5 V supply, while the output uses a 3.3 V supply to provide LVDS compatible outputs. The conversion process is initiated by the rising edge of the external input clock. At that instant, the differential input signal is captured by the input track and hold (T&H) and the input sample is sequentially converted by a series of small resolution stages, with the outputs combined in a digital correction logic block. Both the rising and the falling clock edges are used to propagate the sample through the pipeline every half clock cycle. This process results in a data latency of four clock cycles, after which the output data is available as a 13 bit parallel word, coded in offset binary format.

### Input Configuration

The analog input for the ADS5440 consists of an analog differential buffer followed by a bipolar track-and-hold. The analog buffer isolates the source driving the input of the ADC from any internal switching. The input common mode is set internally through a 500 Ω resistor connected from 2.4 V to each of the inputs. This results in a differential input impedance of 1 kΩ.

For a full-scale differential input, each of the differential lines of the input signal (pins 16 and 17) swings symmetrically between 2.4 +0.55 V and 2.4 -0.55 V. This means that each input has a maximum signal swing of 1.1 V<sub>PP</sub> for a total differential input signal swing of 2.2 V<sub>PP</sub>. The maximum swing is determined by the internal reference voltage generator eliminating the need for any external circuitry for this purpose.

The ADS5440 obtains optimum performance when the analog inputs are driven differentially. The circuit in [Figure 35](#) shows one possible configuration using an RF transformer with termination either on the primary or on the secondary of the transformer. If voltage gain is required, a step up transformer can be used. For voltage gains that would require an impractical transformer turn ratio, a single-ended amplifier driving the transformer is shown in [Figure 36](#).

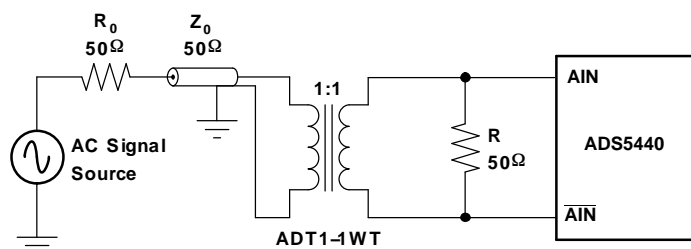

Figure 35. Converting a Single-Ended Input to a Differential Signal Using RF Transformers

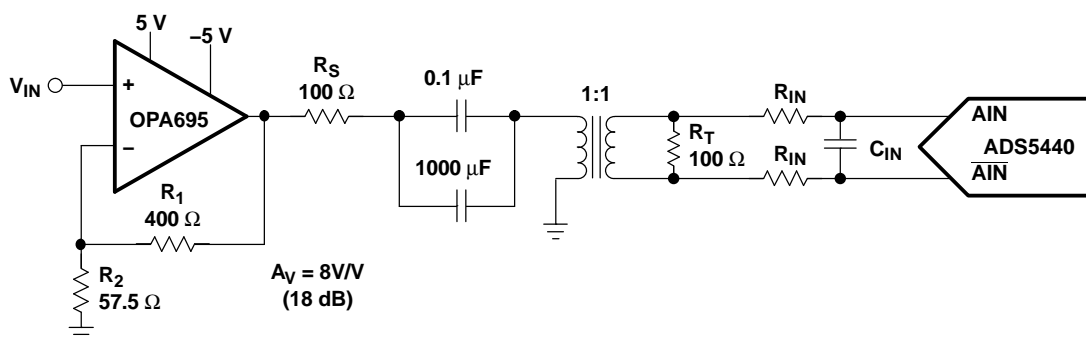

Figure 36. Using the OPA695 With the ADS5440

### Application Information (continued)

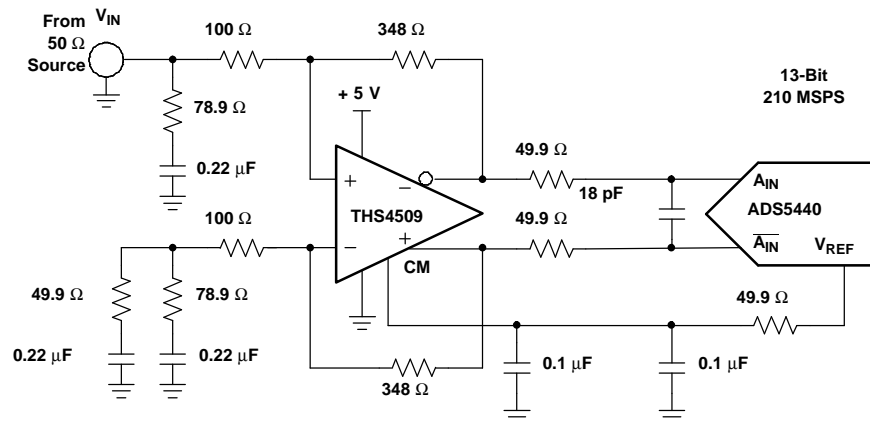

Figure 37. Using the THS4509 With the ADS5440

Besides the OPA695, Texas Instruments offers a wide selection of single-ended operational amplifiers that can be selected depending on the application. An RF gain block amplifier, such as Texas Instrument's THS9001, can also be used with an RF transformer for high input frequency applications. For applications requiring dc-coupling with the signal source, a differential input/differential output amplifier like the THS4509 (see [Figure 37](#)) is a good solution as it minimizes board space and reduces the number of components.

In this configuration, the THS4509 amplifier circuit provides 10 dB of gain, converts the single-ended input to differential, and sets the proper input common-mode voltage to the ADS5440.

The 50  $\Omega$  resistors and 18 pF capacitor between the THS4509 outputs and ADS5440 inputs (along with the input capacitance of the ADC) limit the bandwidth of the signal to about 70 MHz (-3 dB).

Input termination is accomplished via the 78.9  $\Omega$  resistor and 0.22  $\mu$ F capacitor to ground in conjunction with the input impedance of the amplifier circuit. A 0.22  $\mu$ F capacitor and 49.9  $\Omega$  resistor is inserted to ground across the 78.9  $\Omega$  resistor and 0.22  $\mu$ F capacitor on the alternate input to balance the circuit.

Gain is a function of the source impedance, termination, and 348  $\Omega$  feedback resistor. See the THS4509 data sheet for further component values to set proper 50  $\Omega$  termination for other common gains.

Since the ADS5440 recommended input common-mode voltage is +2.4 V, the THS4509 is operated from a single power supply input with  $V_{S+} = +5$  V and  $V_{S-} = 0$  V (ground). This maintains maximum headroom on the internal transistors of the THS4509.

### Clock Inputs

The ADS5440 clock input can be driven with either a differential clock signal or a single-ended clock input, with little or no difference in performance between both configurations. In low input frequency applications, where jitter may not be a big concern, the use of single-ended clock (see [Figure 38](#)) could save some cost and board space without any trade-off in performance. When driven on this configuration, it is best to connect CLK to ground with a 0.01  $\mu$ F capacitor, while CLK is ac-coupled with a 0.01  $\mu$ F capacitor to the clock source, as shown in [Figure 38](#).

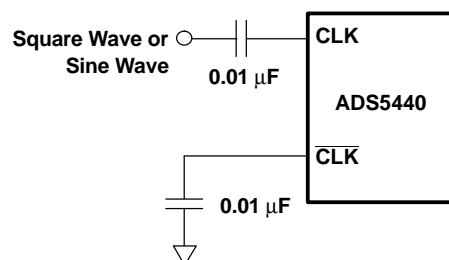

Figure 38. Single-Ended Clock

Application Information (continued)

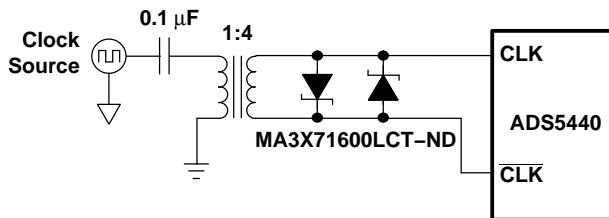

Figure 39. Differential Clock

Nevertheless, for jitter sensitive applications, the use of a differential clock has some advantages (as with any other ADC) at the system level. The first advantage is that it allows for common-mode noise rejection at the PCB level.

A differential clock also allows for the use of bigger clock amplitudes without exceeding the absolute maximum ratings. In the case of a sinusoidal clock, this results in higher slew rates and reduces the impact of clock noise on jitter. See Clocking High Speed Data Converters (SLYT075) for more detail.

Figure 39 shows this approach. The back-to-back Schottky diodes can be added to limit the clock amplitude in cases where this would exceed the absolute maximum ratings, even when using a differential clock.

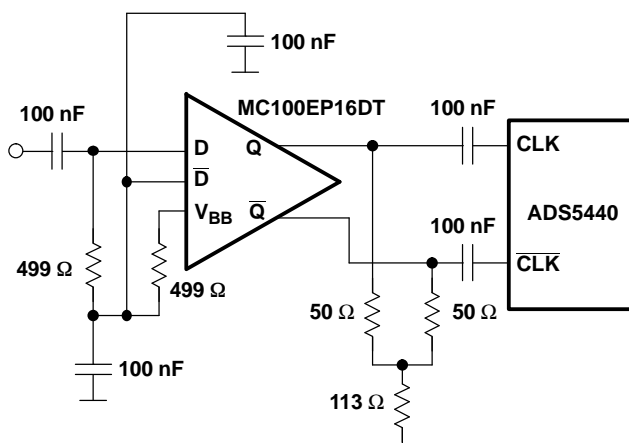

Figure 40. Differential Clock Using PECL Logic

Another possibility is the use of a logic based clock, such as PECL. In this case, the slew rate of the edges will most likely be much higher than the one obtained for the same clock amplitude based on a sinusoidal clock. This solution would minimize the effect of the slope dependent ADC jitter. Using logic gates to square a sinusoidal clock may not produce the best results as logic gates may not have been optimized to act as comparators, adding too much jitter while squaring the inputs.

The common-mode voltage of the clock inputs is set internally to 2.4 V using internal 1 kΩ resistors. It is recommended to use ac coupling, but if this scheme is not possible due to, for instance, asynchronous clocking, the ADS5440 features good tolerance to clock common-mode variation.

Additionally, the internal ADC core uses both edges of the clock for the conversion process. Ideally, a 50% duty cycle clock signal should be provided.

Digital Outputs

The ADC provides 13 data outputs (D12 to D0, with D12 being the MSB and D0 the LSB), a data-ready signal (DRY), and an over-range indicator (OVR) that equals a logic high when the output reaches the full-scale limits. The output format is offset binary. It is recommended to use the DRY signal to capture the output data of the ADS5440.

---

## Application Information (continued)

The ADS5440 digital outputs are LVDS compatible.

### Power Supplies

The use of low noise power supplies with adequate decoupling is recommended. Linear supplies are the preferred choice versus switched ones, which tend to generate more noise components that can be coupled to the ADS5440.

The ADS5440 uses two power supplies. For the analog portion of the design, a 5 V AVDD is used, while for the digital outputs supply (DRVDD) we recommend the use of 3.3 V. All the ground pins are marked as GND, although AGND pins and DRGND pins are not tied together inside the package.

### Layout Information

The evaluation board represents a good guideline of how to layout the board to obtain the maximum performance out of the ADS5440. General design rules as the use of multilayer boards, single ground plane for ADC ground connections and local decoupling ceramic chip capacitors should be applied. The input traces should be isolated from any external source of interference or noise, including the digital outputs as well as the clock traces. The clock signal traces should also be isolated from other signals, especially in applications where low jitter is required as high IF sampling.

Besides performance oriented rules, care has to be taken when considering the heat dissipation out of the device. The thermal heat sink should be soldered to the board as described in the *PowerPad Package* section.

### PowerPAD PACKAGE

The PowerPAD package is a thermally enhanced standard size IC package designed to eliminate the use of bulky heatsinks and slugs traditionally used in thermal packages. This package can be easily mounted using standard printed circuit board (PCB) assembly techniques, and can be removed and replaced using standard repair procedures.

The PowerPAD package is designed so that the leadframe die pad (or thermal pad) is exposed on the bottom of the IC. This provides an extremely low thermal resistance path between the die and the exterior of the package. The thermal pad on the bottom of the IC can then be soldered directly to the printed circuit board (PCB), using the PCB as a heatsink.

### Assembly Process

1. Prepare the PCB top-side etch pattern including etch for the leads as well as the thermal pad as illustrated in the Mechanical Data section.
2. Place a 6-by-6 array of thermal vias in the thermal pad area. These holes should be 13 mils in diameter. The small size prevents wicking of the solder through the holes.
3. It is recommended to place a small number of 25 mil diameter holes under the package, but outside the thermal pad area to provide an additional heat path.
4. Connect all holes (both those inside and outside the thermal pad area) to an internal copper plane (such as a ground plane).
5. Do not use the typical web or spoke via connection pattern when connecting the thermal vias to the ground plane. The spoke pattern increases the thermal resistance to the ground plane.
6. The top-side solder mask should leave exposed the terminals of the package and the thermal pad area.
7. Cover the entire bottom side of the PowerPAD vias to prevent solder wicking.
8. Apply solder paste to the exposed thermal pad area and all of the package terminals.

For more detailed information regarding the PowerPAD package and its thermal properties, see either the [SLMA004](#) Application Brief *PowerPAD Made Easy* or the [SLMA002](#) Technical Brief *PowerPAD Thermally Enhanced Package*.

**PACKAGING INFORMATION**

| Orderable Device | Status <sup>(1)</sup> | Package Type | Package Drawing | Pins | Package Qty | Eco Plan <sup>(2)</sup>    | Lead/<br>Ball Finish | MSL Peak Temp <sup>(3)</sup> | Samples<br>(Requires Login) |
|------------------|-----------------------|--------------|-----------------|------|-------------|----------------------------|----------------------|------------------------------|-----------------------------|
| ADS5440IPFP      | ACTIVE                | HTQFP        | PFP             | 80   | 96          | Green (RoHS<br>& no Sb/Br) | CU NIPDAU            | Level-4-260C-72 HR           |                             |
| ADS5440IPFPR     | ACTIVE                | HTQFP        | PFP             | 80   |             | TBD                        | Call TI              | Call TI                      |                             |

<sup>(1)</sup> The marketing status values are defined as follows:

**ACTIVE:** Product device recommended for new designs.

**LIFEBUY:** TI has announced that the device will be discontinued, and a lifetime-buy period is in effect.

**NRND:** Not recommended for new designs. Device is in production to support existing customers, but TI does not recommend using this part in a new design.

**PREVIEW:** Device has been announced but is not in production. Samples may or may not be available.

**OBSELETE:** TI has discontinued the production of the device.

<sup>(2)</sup> Eco Plan - The planned eco-friendly classification: Pb-Free (RoHS), Pb-Free (RoHS Exempt), or Green (RoHS & no Sb/Br) - please check <http://www.ti.com/productcontent> for the latest availability information and additional product content details.

**TBD:** The Pb-Free/Green conversion plan has not been defined.

**Pb-Free (RoHS):** TI's terms "Lead-Free" or "Pb-Free" mean semiconductor products that are compatible with the current RoHS requirements for all 6 substances, including the requirement that lead not exceed 0.1% by weight in homogeneous materials. Where designed to be soldered at high temperatures, TI Pb-Free products are suitable for use in specified lead-free processes.

**Pb-Free (RoHS Exempt):** This component has a RoHS exemption for either 1) lead-based flip-chip solder bumps used between the die and package, or 2) lead-based die adhesive used between the die and leadframe. The component is otherwise considered Pb-Free (RoHS compatible) as defined above.

**Green (RoHS & no Sb/Br):** TI defines "Green" to mean Pb-Free (RoHS compatible), and free of Bromine (Br) and Antimony (Sb) based flame retardants (Br or Sb do not exceed 0.1% by weight in homogeneous material)

<sup>(3)</sup> MSL, Peak Temp. -- The Moisture Sensitivity Level rating according to the JEDEC industry standard classifications, and peak solder temperature.

**Important Information and Disclaimer:** The information provided on this page represents TI's knowledge and belief as of the date that it is provided. TI bases its knowledge and belief on information provided by third parties, and makes no representation or warranty as to the accuracy of such information. Efforts are underway to better integrate information from third parties. TI has taken and continues to take reasonable steps to provide representative and accurate information but may not have conducted destructive testing or chemical analysis on incoming materials and chemicals. TI and TI suppliers consider certain information to be proprietary, and thus CAS numbers and other limited information may not be available for release.

In no event shall TI's liability arising out of such information exceed the total purchase price of the TI part(s) at issue in this document sold by TI to Customer on an annual basis.

**OTHER QUALIFIED VERSIONS OF ADS5440 :**

- Enhanced Product: [ADS5440-EP](#)

NOTE: Qualified Version Definitions:

- Enhanced Product - Supports Defense, Aerospace and Medical Applications

# MECHANICAL DATA

PFP (S-PQFP-G80)

PowerPAD™ PLASTIC QUAD FLATPACK

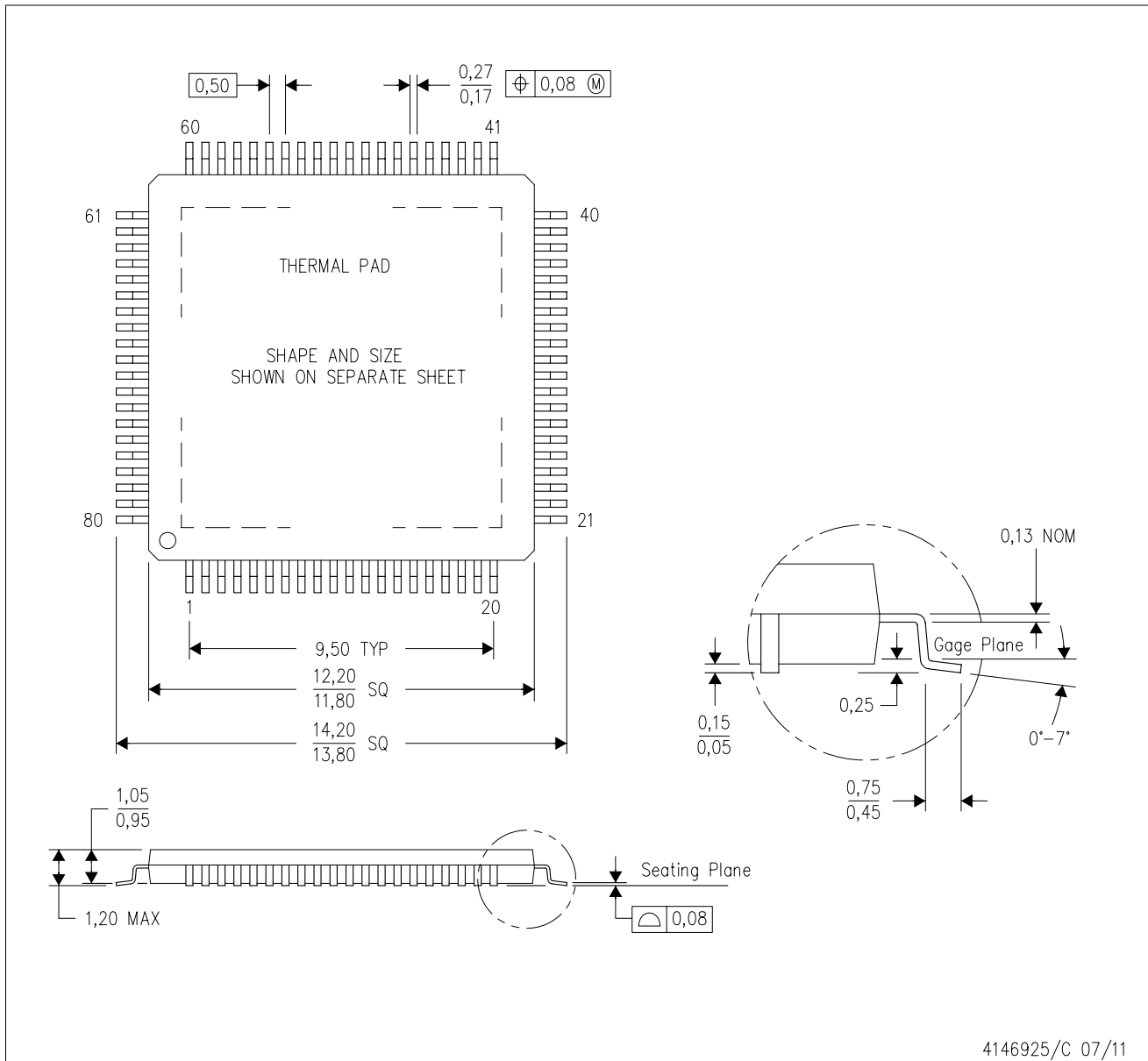

- NOTES:
- A. All linear dimensions are in millimeters.
  - B. This drawing is subject to change without notice.
  - C. Body dimensions do not include mold flash or protrusion
  - D. This package is designed to be soldered to a thermal pad on the board. Refer to Technical Brief, PowerPad Thermally Enhanced Package, Texas Instruments Literature No. SLMA002 for information regarding recommended board layout. This document is available at [www.ti.com](http://www.ti.com) <<http://www.ti.com>>.
  - E. See the additional figure in the Product Data Sheet for details regarding the exposed thermal pad features and dimensions.
  - F. Falls within JEDEC MS-026

PowerPAD is a trademark of Texas Instruments.

## THERMAL PAD MECHANICAL DATA

PFP (S-PQFP-G80)

PowerPAD™ PLASTIC QUAD FLATPACK

### THERMAL INFORMATION

This PowerPAD™ package incorporates an exposed thermal pad that is designed to be attached to a printed circuit board (PCB). The thermal pad must be soldered directly to the PCB. After soldering, the PCB can be used as a heatsink. In addition, through the use of thermal vias, the thermal pad can be attached directly to the appropriate copper plane shown in the electrical schematic for the device, or alternatively, can be attached to a special heatsink structure designed into the PCB. This design optimizes the heat transfer from the integrated circuit (IC).

For additional information on the PowerPAD package and how to take advantage of its heat dissipating abilities, refer to Technical Brief, PowerPAD Thermally Enhanced Package, Texas Instruments Literature No. SLMA002 and Application Brief, PowerPAD Made Easy, Texas Instruments Literature No. SLMA004. Both documents are available at [www.ti.com](http://www.ti.com).

The exposed thermal pad dimensions for this package are shown in the following illustration.

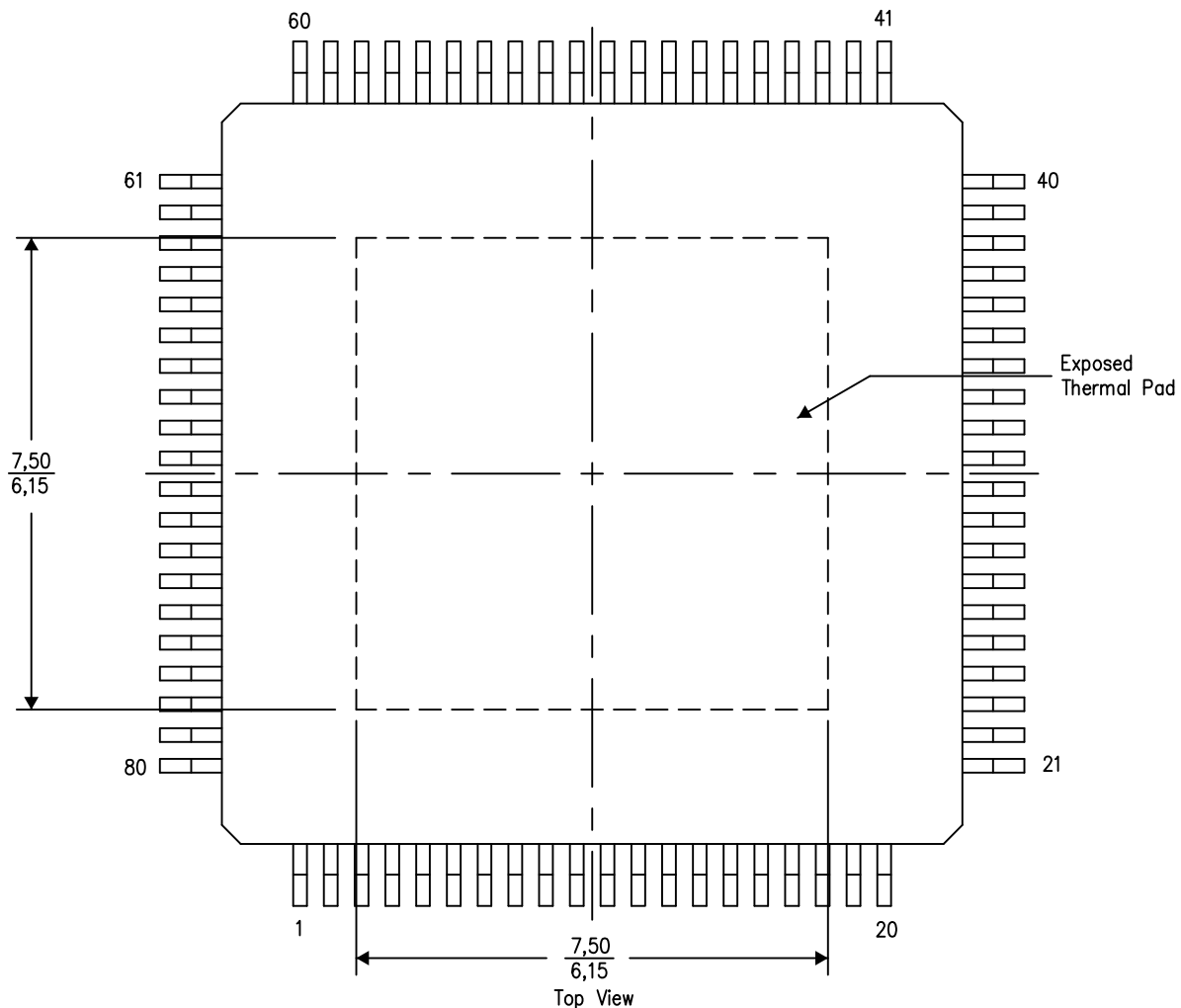

4206327-2/0 07/12

NOTE: A. All linear dimensions are in millimeters

PowerPAD is a trademark of Texas Instruments

# LAND PATTERN DATA

PFP (S-PQFP-G80)

PowerPAD™ PLASTIC QUAD FLATPACK

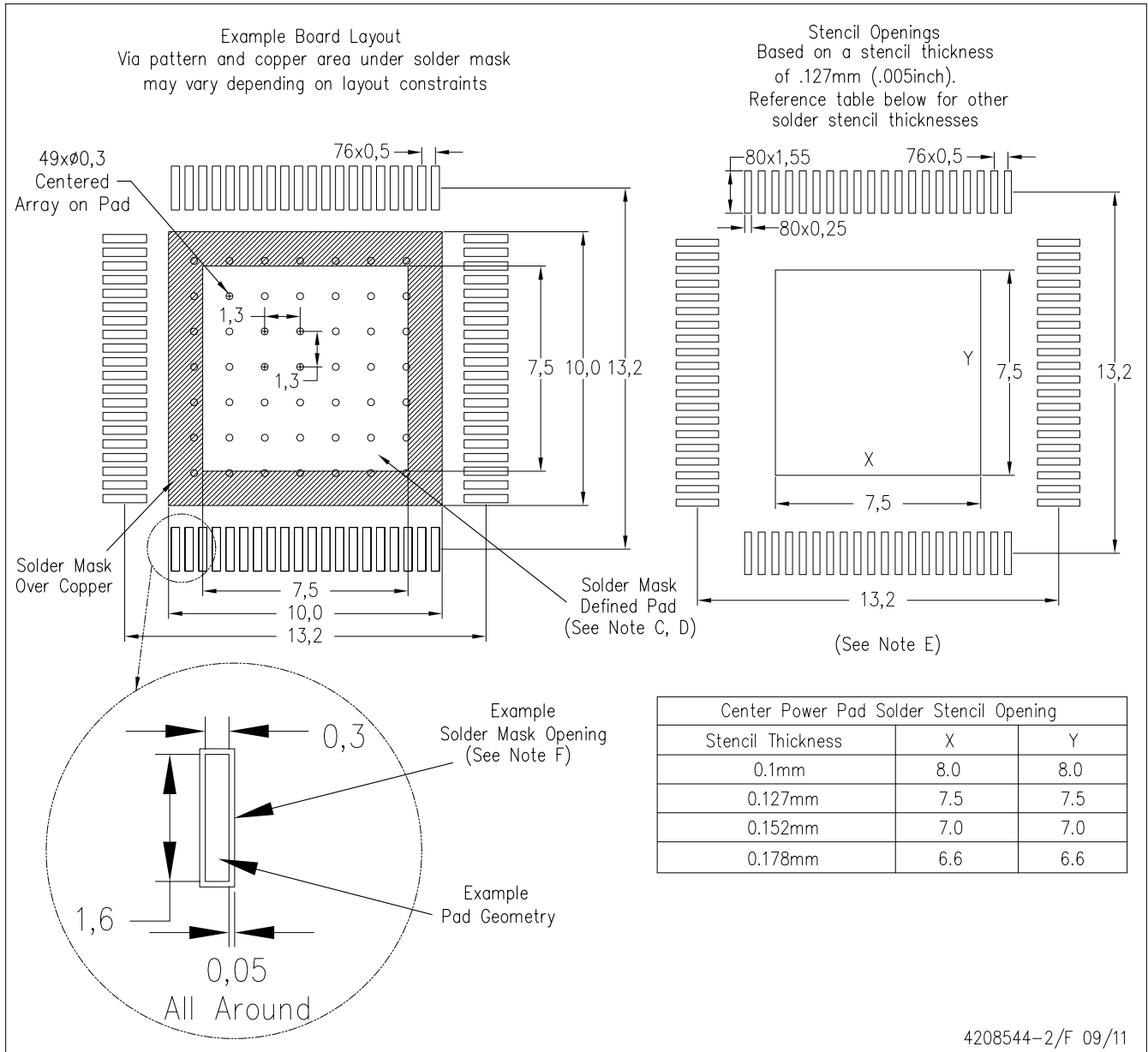

- NOTES:
- All linear dimensions are in millimeters.
  - This drawing is subject to change without notice.
  - Customers should place a note on the circuit board fabrication drawing not to alter the center solder mask defined pad.
  - This package is designed to be soldered to a thermal pad on the board. Refer to Technical Brief, PowerPad Thermally Enhanced Package, Texas Instruments Literature No. SLMA002, SLMA004, and also the Product Data Sheets for specific thermal information, via requirements, and recommended board layout. These documents are available at [www.ti.com](http://www.ti.com) <<http://www.ti.com>>. Publication IPC-7351 is recommended for alternate designs.
  - Laser cutting apertures with trapezoidal walls and also rounding corners will offer better paste release. Customers should contact their board assembly site for stencil design recommendations. Example stencil design based on a 50% volumetric metal load solder paste. Refer to IPC-7525 for other stencil recommendations.
  - Customers should contact their board fabrication site for solder mask tolerances between and around signal pads.

PowerPAD is a trademark of Texas Instruments.

## IMPORTANT NOTICE

Texas Instruments Incorporated and its subsidiaries (TI) reserve the right to make corrections, enhancements, improvements and other changes to its semiconductor products and services per JESD46C and to discontinue any product or service per JESD48B. Buyers should obtain the latest relevant information before placing orders and should verify that such information is current and complete. All semiconductor products (also referred to herein as "components") are sold subject to TI's terms and conditions of sale supplied at the time of order acknowledgment.

TI warrants performance of its components to the specifications applicable at the time of sale, in accordance with the warranty in TI's terms and conditions of sale of semiconductor products. Testing and other quality control techniques are used to the extent TI deems necessary to support this warranty. Except where mandated by applicable law, testing of all parameters of each component is not necessarily performed.

TI assumes no liability for applications assistance or the design of Buyers' products. Buyers are responsible for their products and applications using TI components. To minimize the risks associated with Buyers' products and applications, Buyers should provide adequate design and operating safeguards.

TI does not warrant or represent that any license, either express or implied, is granted under any patent right, copyright, mask work right, or other intellectual property right relating to any combination, machine, or process in which TI components or services are used. Information published by TI regarding third-party products or services does not constitute a license to use such products or services or a warranty or endorsement thereof. Use of such information may require a license from a third party under the patents or other intellectual property of the third party, or a license from TI under the patents or other intellectual property of TI.

Reproduction of significant portions of TI information in TI data books or data sheets is permissible only if reproduction is without alteration and is accompanied by all associated warranties, conditions, limitations, and notices. TI is not responsible or liable for such altered documentation. Information of third parties may be subject to additional restrictions.

Resale of TI components or services with statements different from or beyond the parameters stated by TI for that component or service voids all express and any implied warranties for the associated TI component or service and is an unfair and deceptive business practice. TI is not responsible or liable for any such statements.

Buyer acknowledges and agrees that it is solely responsible for compliance with all legal, regulatory and safety-related requirements concerning its products, and any use of TI components in its applications, notwithstanding any applications-related information or support that may be provided by TI. Buyer represents and agrees that it has all the necessary expertise to create and implement safeguards which anticipate dangerous consequences of failures, monitor failures and their consequences, lessen the likelihood of failures that might cause harm and take appropriate remedial actions. Buyer will fully indemnify TI and its representatives against any damages arising out of the use of any TI components in safety-critical applications.

In some cases, TI components may be promoted specifically to facilitate safety-related applications. With such components, TI's goal is to help enable customers to design and create their own end-product solutions that meet applicable functional safety standards and requirements. Nonetheless, such components are subject to these terms.

No TI components are authorized for use in FDA Class III (or similar life-critical medical equipment) unless authorized officers of the parties have executed a special agreement specifically governing such use.

Only those TI components which TI has specifically designated as military grade or "enhanced plastic" are designed and intended for use in military/aerospace applications or environments. Buyer acknowledges and agrees that any military or aerospace use of TI components which have **not** been so designated is solely at the Buyer's risk, and that Buyer is solely responsible for compliance with all legal and regulatory requirements in connection with such use.

TI has specifically designated certain components which meet ISO/TS16949 requirements, mainly for automotive use. Components which have not been so designated are neither designed nor intended for automotive use; and TI will not be responsible for any failure of such components to meet such requirements.

### Products

|                        |  |
|------------------------|--|
| Audio                  | <a href="http://www.ti.com/audio">www.ti.com/audio</a>                               |
| Amplifiers             | <a href="http://amplifier.ti.com">amplifier.ti.com</a>                               |
| Data Converters        | <a href="http://dataconverter.ti.com">dataconverter.ti.com</a>                       |
| DLP® Products          | <a href="http://www.dlp.com">www.dlp.com</a>   |
| DSP                    | <a href="http://dsp.ti.com">dsp.ti.com</a>   |
| Clocks and Timers      | <a href="http://www.ti.com/clocks">www.ti.com/clocks</a>                             |
| Interface              | <a href="http://interface.ti.com">interface.ti.com</a>                               |
| Logic                  | <a href="http://logic.ti.com">logic.ti.com</a>                                       |
| Power Mgmt             | <a href="http://power.ti.com">power.ti.com</a>                                       |
| Microcontrollers       | <a href="http://microcontroller.ti.com">microcontroller.ti.com</a>                   |
| RFID                   | <a href="http://www.ti-rfid.com">www.ti-rfid.com</a>                                 |
| OMAP Mobile Processors | <a href="http://www.ti.com/omap">www.ti.com/omap</a>                                 |
| Wireless Connectivity  | <a href="http://www.ti.com/wirelessconnectivity">www.ti.com/wirelessconnectivity</a> |

### Applications

|                               |  |
|-------------------------------|--|
| Automotive and Transportation | <a href="http://www.ti.com/automotive">www.ti.com/automotive</a>                         |
| Communications and Telecom    | <a href="http://www.ti.com/communications">www.ti.com/communications</a>                 |
| Computers and Peripherals     | <a href="http://www.ti.com/computers">www.ti.com/computers</a>                           |
| Consumer Electronics          | <a href="http://www.ti.com/consumer-apps">www.ti.com/consumer-apps</a>                   |
| Energy and Lighting           | <a href="http://www.ti.com/energy">www.ti.com/energy</a>                                 |
| Industrial                    | <a href="http://www.ti.com/industrial">www.ti.com/industrial</a>                         |
| Medical                       | <a href="http://www.ti.com/medical">www.ti.com/medical</a>                               |
| Security                      | <a href="http://www.ti.com/security">www.ti.com/security</a>                             |
| Space, Avionics and Defense   | <a href="http://www.ti.com/space-avionics-defense">www.ti.com/space-avionics-defense</a> |
| Video and Imaging             | <a href="http://www.ti.com/video">www.ti.com/video</a>                                   |

**TI E2E Community** [e2e.ti.com](http://e2e.ti.com)