

## Dual-Channel, 14- and 16-Bit, 250-MSPS Analog-to-Digital Converters

Check for Samples: [ADS42LB49](#), [ADS42LB69](#)

### FEATURES

- Dual Channel
- 14- and 16-Bit Resolution
- Maximum Clock Rate: 250 MSPS
- Analog Input Buffer with High Impedance Input
- Flexible Input Clock Buffer with Divide-by-1, -2, and -4
- 2- $V_{PP}$  and 2.5- $V_{PP}$  Differential Full-Scale Input (SPI-Programmable)
- DDR or QDR LVDS Interface
- 64-Pin QFN Package (9-mm x 9-mm)
- Power Dissipation: 820 mW/ch
- Aperture Jitter: 85  $f_s$
- Internal Dither
- Channel Isolation: 100 dB
- Performance at  $f_{IN} = 170$  MHz at 2  $V_{PP}$ , -1 dBFS
  - SNR: 73.2 dBFS
  - SFDR:
    - 87 dBc (HD2 and HD3)
    - 100 dBc (Non HD2 and HD3)
- Performance at  $f_{IN} = 170$  MHz: 2.5  $V_{PP}$ , -1 dBFS
  - SNR: 74.9 dBFS
  - SFDR:
    - 85 dBc (HD2 and HD3)
    - 97 dBc (Non HD2 and HD3)

### APPLICATIONS

- Communication and Cable Infrastructure
- Multi-Carrier, Multimode Cellular Receivers
- Radar and Smart Antenna Arrays
- Broadband Wireless
- Test and Measurement Systems
- Software-Defined and Diversity Radios
- Microwave and Dual-Channel I/Q Receivers
- Repeaters
- Power Amplifier Linearization

### DESCRIPTION

The ADS42LB49 and ADS42LB69 are a family of high-linearity, dual-channel, 14- and 16-bit, 250-MSPS, analog-to-digital converters (ADCs) supporting DDR and QDR LVDS output interfaces. The buffered analog input provides uniform input impedance across a wide frequency range while minimizing sample-and-hold glitch energy. A sampling clock divider allows more flexibility for system clock architecture design. The ADS42LB49 and ADS42LB69 provide excellent spurious-free dynamic range (SFDR) over a large input frequency range with low-power consumption.

**Table 1. Family Comparison**

INTERFACE OPTION	14-BIT	16-BIT
DDR, QDR LVDS	ADS42LB49	ADS42LB69
JESD204B	ADS42JB49	ADS42JB69

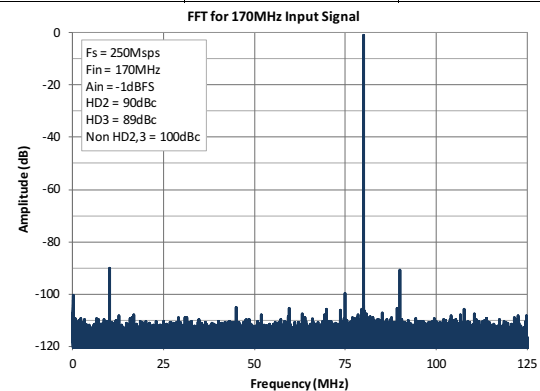
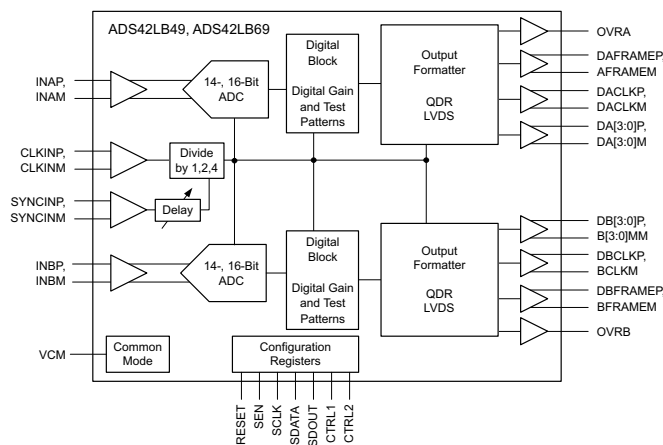

Please be aware that an important notice concerning availability, standard warranty, and use in critical applications of Texas Instruments semiconductor products and disclaimers thereto appears at the end of this data sheet.

All trademarks are the property of their respective owners.



This integrated circuit can be damaged by ESD. Texas Instruments recommends that all integrated circuits be handled with appropriate precautions. Failure to observe proper handling and installation procedures can cause damage.

ESD damage can range from subtle performance degradation to complete device failure. Precision integrated circuits may be more susceptible to damage because very small parametric changes could cause the device not to meet its published specifications.

### ORDERING INFORMATION<sup>(1)</sup>

(1) For the most current package and ordering information, see the Package Option Addendum at the end of this document, or visit the device product folder at [www.ti.com](http://www.ti.com).

### ABSOLUTE MAXIMUM RATINGS

Over operating free-air temperature range, unless otherwise noted.

		VALUE		UNIT
		MIN	MAX	
Supply voltage range	AVDD3V	-0.3	3.6	V
	AVDD	-0.3	2.1	V
	DRVDD	-0.3	2.1	V
Voltage between AGND and DGND		-0.3	0.3	V
Voltage applied to input pins	INA, INBP, INA, INBM	-0.3	3	V
	CLKINP, CLKINM	-0.3	AVDD + 0.3	V
	SYNCINP, SYNCINM	-0.3	AVDD + 0.3	V
	SCLK, SEN, SDATA, RESET, CTRL1, CTRL2	-0.3	3.9	V
Temperature range	Operating free-air, T <sub>A</sub>	-40	+85	°C
	Operating junction, T <sub>J</sub>		+125	°C
	Storage, T <sub>stg</sub>	-65	+150	°C
Electrostatic discharge (ESD) ratings	Human body model (HBM)		2	kV

### THERMAL INFORMATION

THERMAL METRIC <sup>(1)</sup>		ADS42LB49, ADS42LB69	UNITS
		RGC (QFN)	
		64 PINS	
$\theta_{JA}$	Junction-to-ambient thermal resistance	22.9	°C/W
$\theta_{JcTop}$	Junction-to-case (top) thermal resistance	7.1	
$\theta_{JB}$	Junction-to-board thermal resistance	2.5	
$\Psi_{JT}$	Junction-to-top characterization parameter	0.1	
$\Psi_{JB}$	Junction-to-board characterization parameter	2.5	
$\theta_{JcBot}$	Junction-to-case (bottom) thermal resistance	0.2	

(1) For more information about traditional and new thermal metrics, see the *IC Package Thermal Metrics* application report, [SPRA953](http://www.ti.com/lit/zip/Spra953).

## RECOMMENDED OPERATING CONDITIONS<sup>(1)</sup>

Over operating free-air temperature range, unless otherwise noted.

PARAMETER		MIN	NOM	MAX	UNIT
<b>SUPPLIES</b>					
AVDD	Analog supply voltage	1.7	1.8	1.9	V
AVDD3V	Analog buffer supply voltage	3.15	3.3	3.45	V
DRVDD	Digital supply voltage	1.7	1.8	1.9	V
<b>ANALOG INPUTS</b>					
V <sub>ID</sub>	Differential input voltage range	Default after reset			V <sub>PP</sub>
		Register programmable <sup>(2)</sup>			V <sub>PP</sub>
V <sub>ICR</sub>	Input common-mode voltage	VCM ± 0.025			V
	Maximum analog input frequency with 2.5-V <sub>PP</sub> input amplitude	250			MHz
	Maximum analog input frequency with 2-V <sub>PP</sub> input amplitude	400			MHz
<b>CLOCK INPUT</b>					
Input clock sample rate	QDR interface	30		250	MSPS
	DDR interface	10		250	MSPS
Input clock amplitude differential (V <sub>CLKP</sub> – V <sub>CLKM</sub> )	Sine wave, ac-coupled	0.3 <sup>(3)</sup>	1.5		V <sub>PP</sub>
	LVPECL, ac-coupled		1.6		V <sub>PP</sub>
	LVDS, ac-coupled		0.7		V <sub>PP</sub>
	LVC MOS, single-ended, ac-coupled		1.5		V
	Input clock duty cycle	35%	50%	65%	
<b>DIGITAL OUTPUTS</b>					
C <sub>LOAD</sub>	Maximum external load capacitance from each output pin to DRGND	3.3			pF
R <sub>LOAD</sub>	Single-ended load resistance	+50			Ω
T <sub>A</sub>	Operating free-air temperature	–40		+85	°C

- (1) After power-up, to reset the device for the first time, *only use the RESET pin*. Refer to the [Register Initialization](#) section.  
 (2) For details, refer to the [Digital Gain](#) section.  
 (3) Refer to the [Performance vs Clock Amplitude](#) curves, [Figure 37](#) and [Figure 38](#).

**Table 2. High-Frequency Modes Summary**

REGISTER ADDRESS	VALUE	DESCRIPTION
Dh	90h	Enable high-frequency modes for input frequencies greater than 250 MHz.
Eh	90h	Enable high-frequency modes for input frequencies greater than 250 MHz.

**ELECTRICAL CHARACTERISTICS: ADS42LB69 (16-Bit)**

Typical values are at  $T_A = +25^\circ\text{C}$ ,  $AVDD = 1.8\text{ V}$ ,  $AVDD3V = 3.3\text{ V}$ ,  $DRVDD = 1.8\text{ V}$ , 50% clock duty cycle,  $-1\text{ dBFS}$  differential analog input, and sampling rate = 250 MSPS, unless otherwise noted. Minimum and maximum values are across the full temperature range of  $T_{MIN} = -40^\circ\text{C}$  to  $T_{MAX} = +85^\circ\text{C}$ ,  $AVDD = 1.8\text{ V}$ ,  $AVDD3V = 3.3\text{ V}$ ,  $DRVDD = 1.8\text{ V}$ .

PARAMETER	TEST CONDITIONS	2-V <sub>PP</sub> FULL-SCALE			2.5-V <sub>PP</sub> FULL-SCALE			UNITS
		MIN	TYP	MAX	MIN	TYP	MAX	
SNR Signal-to-noise ratio	$f_{IN} = 10\text{ MHz}$		73.9			75.8		dBFS
	$f_{IN} = 70\text{ MHz}$		73.7			75.5		dBFS
	$f_{IN} = 170\text{ MHz}$	70.8	73.2			74.7		dBFS
	$f_{IN} = 230\text{ MHz}$		72.8			74.1		dBFS
SINAD Signal-to-noise and distortion ratio	$f_{IN} = 10\text{ MHz}$		73.7			75.1		dBFS
	$f_{IN} = 70\text{ MHz}$		73.6			75.3		dBFS
	$f_{IN} = 170\text{ MHz}$	69.6	73.1			74.2		dBFS
	$f_{IN} = 230\text{ MHz}$		72.5			73.4		dBFS
SFDR Spurious-free dynamic range (including second and third harmonic distortion)	$f_{IN} = 10\text{ MHz}$		87			83		dBc
	$f_{IN} = 70\text{ MHz}$		90			88		dBc
	$f_{IN} = 170\text{ MHz}$	81	87			85		dBc
	$f_{IN} = 230\text{ MHz}$		86			83		dBc
THD Total harmonic distortion	$f_{IN} = 10\text{ MHz}$		86			82		dBc
	$f_{IN} = 70\text{ MHz}$		89			87		dBc
	$f_{IN} = 170\text{ MHz}$	78	85			82		dBc
	$f_{IN} = 230\text{ MHz}$		83			81		dBc
HD2 2nd-order harmonic distortion	$f_{IN} = 10\text{ MHz}$		97			95		dBc
	$f_{IN} = 70\text{ MHz}$		90			88		dBc
	$f_{IN} = 170\text{ MHz}$	81	87			85		dBc
	$f_{IN} = 230\text{ MHz}$		86			84		dBc
HD3 3rd-order harmonic distortion	$f_{IN} = 10\text{ MHz}$		87			83		dBc
	$f_{IN} = 70\text{ MHz}$		96			94		dBc
	$f_{IN} = 170\text{ MHz}$	81	91			85		dBc
	$f_{IN} = 230\text{ MHz}$		87			83		dBc
Worst spur (other than second and third harmonics)	$f_{IN} = 10\text{ MHz}$		102			103		dBc
	$f_{IN} = 70\text{ MHz}$		101			103		dBc
	$f_{IN} = 170\text{ MHz}$	87	101			101		dBc
	$f_{IN} = 230\text{ MHz}$		100			100		dBc
IMD Two-tone intermodulation distortion	$f_1 = 46\text{ MHz}$ , $f_2 = 50\text{ MHz}$ , each tone at $-7\text{ dBFS}$		97			94		dBFS
	$f_1 = 185\text{ MHz}$ , $f_2 = 190\text{ MHz}$ , each tone at $-7\text{ dBFS}$		94			90		dBFS
Crosstalk	20-MHz, full-scale signal on channel under observation; 170-MHz, full-scale signal on other channel		100			100		dB
Input overload recovery	Recovery to within 1% (of full-scale) for 6-dB overload with sine-wave input		1			1		Clock cycle
PSRR AC power-supply rejection ratio	For 50-mV <sub>PP</sub> signal on AVDD supply, up to 10 MHz		> 40			> 40		dB
ENOB Effective number of bits	$f_{IN} = 170\text{ MHz}$		11.85			12.03		LSBs
DNL Differential nonlinearity	$f_{IN} = 170\text{ MHz}$		±0.6			±0.6		LSBs
INL Integrated nonlinearity	$f_{IN} = 170\text{ MHz}$		±3	±8		±3.5		LSBs

**ELECTRICAL CHARACTERISTICS: ADS42LB49 (14-Bit)**

Typical values are at  $T_A = +25^\circ\text{C}$ ,  $AVDD = 1.8\text{ V}$ ,  $AVDD3V = 3.3\text{ V}$ ,  $DRVDD = 1.8\text{ V}$ , 50% clock duty cycle,  $-1\text{ dBFS}$  differential analog input, and sampling rate = 250 MSPS, unless otherwise noted. Minimum and maximum values are across the full temperature range of  $T_{\text{MIN}} = -40^\circ\text{C}$  to  $T_{\text{MAX}} = +85^\circ\text{C}$ ,  $AVDD = 1.8\text{ V}$ ,  $AVDD3V = 3.3\text{ V}$ ,  $DRVDD = 1.8\text{ V}$ .

PARAMETER	TEST CONDITIONS	2-V <sub>pp</sub> FULL-SCALE			2.5-V <sub>pp</sub> FULL-SCALE			UNITS
		MIN	TYP	MAX	MIN	TYP	MAX	
SNR Signal-to-noise ratio	$f_{\text{IN}} = 10\text{ MHz}$		73.3			74.9		dBFS
	$f_{\text{IN}} = 70\text{ MHz}$		73.1			74.7		dBFS
	$f_{\text{IN}} = 170\text{ MHz}$	69.5	72.7			74.1		dBFS
	$f_{\text{IN}} = 230\text{ MHz}$		72.3			73.5		dBFS
SINAD Signal-to-noise and distortion ratio	$f_{\text{IN}} = 10\text{ MHz}$		73.1			74.1		dBFS
	$f_{\text{IN}} = 70\text{ MHz}$		73.1			74.4		dBFS
	$f_{\text{IN}} = 170\text{ MHz}$	68.5	72.6			73.6		dBFS
	$f_{\text{IN}} = 230\text{ MHz}$		72			72.9		dBFS
SFDR Spurious-free dynamic range (including second and third harmonic distortion)	$f_{\text{IN}} = 10\text{ MHz}$		87			82		dBc
	$f_{\text{IN}} = 70\text{ MHz}$		90			88		dBc
	$f_{\text{IN}} = 170\text{ MHz}$	79	87			85		dBc
	$f_{\text{IN}} = 230\text{ MHz}$		86			83		dBc
THD Total harmonic distortion	$f_{\text{IN}} = 10\text{ MHz}$		86			81		dBc
	$f_{\text{IN}} = 70\text{ MHz}$		89			87		dBc
	$f_{\text{IN}} = 170\text{ MHz}$	76	85			82		dBc
	$f_{\text{IN}} = 230\text{ MHz}$		83			81		dBc
HD2 2nd-order harmonic distortion	$f_{\text{IN}} = 10\text{ MHz}$		97			95		dBc
	$f_{\text{IN}} = 70\text{ MHz}$		90			88		dBc
	$f_{\text{IN}} = 170\text{ MHz}$	79	87			85		dBc
	$f_{\text{IN}} = 230\text{ MHz}$		86			84		dBc
HD3 3rd-order harmonic distortion	$f_{\text{IN}} = 10\text{ MHz}$		87			82		dBc
	$f_{\text{IN}} = 70\text{ MHz}$		96			94		dBc
	$f_{\text{IN}} = 170\text{ MHz}$	79	91			85		dBc
	$f_{\text{IN}} = 230\text{ MHz}$		87			83		dBc
Worst spur (other than second and third harmonics)	$f_{\text{IN}} = 10\text{ MHz}$		104			103		dBc
	$f_{\text{IN}} = 70\text{ MHz}$		101			103		dBc
	$f_{\text{IN}} = 170\text{ MHz}$	87	100			101		dBc
	$f_{\text{IN}} = 230\text{ MHz}$		99			100		dBc
IMD Two-tone intermodulation distortion	$f_1 = 46\text{ MHz}$ , $f_2 = 50\text{ MHz}$ , each tone at $-7\text{ dBFS}$		99			95		dBFS
	$f_1 = 185\text{ MHz}$ , $f_2 = 190\text{ MHz}$ , each tone at $-7\text{ dBFS}$		93			93		dBFS
Crosstalk	20-MHz, full-scale signal on channel under observation; 170-MHz, full-scale signal on other channel		100			90		dB
Input overload recovery	Recovery to within 1% (of full-scale) for 6-dB overload with sine-wave input		1			1		Clock cycle
PSRR AC power-supply rejection ratio	For a 50-mV <sub>pp</sub> signal on AVDD supply, up to 10 MHz		> 40			> 40		dB
ENOB Effective number of bits	$f_{\text{IN}} = 170\text{ MHz}$		11.76			11.93		LSBs
DNL Differential nonlinearity	$f_{\text{IN}} = 170\text{ MHz}$		±0.15			±0.15		LSBs
INL Integrated nonlinearity	$f_{\text{IN}} = 170\text{ MHz}$		±0.75	±3		±0.9		LSBs

### ELECTRICAL CHARACTERISTICS: General

Typical values are at +25°C, AVDD = 1.8 V, AVDD3V = 3.3 V, DRVDD = 1.8 V, 50% clock duty cycle, –1-dBFS differential analog input, and sampling rate = 250 MSPS, unless otherwise noted. Minimum and maximum values are across the full temperature range: T<sub>MIN</sub> = –40°C to T<sub>MAX</sub> = +85°C, AVDD = 1.8 V, AVDD3V = 3.3 V, DRVDD = 1.8 V.

PARAMETER		TEST CONDITIONS	MIN	TYP	MAX	UNIT
<b>ANALOG INPUTS</b>						
V <sub>ID</sub>	Differential input voltage range	Default (after reset)		2		V <sub>PP</sub>
		Register programmed <sup>(1)</sup>		2.5		V <sub>PP</sub>
		Differential input resistance (at 170 MHz)		1.2		kΩ
		Differential input capacitance (at 170 MHz)		4		pF
	Analog input bandwidth	With 50-Ω source impedance, and 50-Ω termination		900		MHz
VCM	Common-mode output voltage			1.9		V
	VCM output current capability			10		mA
<b>DC ACCURACY</b>						
	Offset error		–20		20	mV
E <sub>GREF</sub>	Gain error as a result of internal reference inaccuracy alone			±2		%FS
E <sub>GCHAN</sub>	Gain error of channel alone			–5		%FS
	Temperature coefficient of E <sub>GCHAN</sub>			0.01		Δ%/°C
<b>POWER SUPPLY</b>						
IAVDD	Analog supply current			141	182	mA
IAVDD3V	Analog buffer supply current			302	340	mA
IDRVDD	Digital and Output buffer supply current	External 100-Ω differential termination on LVDS outputs		219	245	mA
	Analog power			253		mW
	Analog buffer power			996		mW
	Power consumption (includes digital blocks and output buffers)	External 100-Ω differential termination on LVDS outputs		393		mW
	Total power			1.64	1.85	W
	Global power-down (both channels)				160	mW

(1) Refer to the [Serial Interface](#) section.

### TIMING REQUIREMENTS: General

Typical values are at +25°C, AVDD = 1.8 V, AVDD3V = 3.3 V, DRVDD = 1.8 V, sampling frequency = 250 MSPS, sine wave input clock, C<sub>LOAD</sub> = 3.3 pF, and R<sub>LOAD</sub> = 100 Ω, unless otherwise noted. Minimum and maximum values are across the full temperature range: T<sub>MIN</sub> = -40°C to T<sub>MAX</sub> = +85°C, AVDD = 1.8 V, AVDD3V = 3.3 V, DRVDD = 1.7 V to 1.9 V.

PARAMETER	DESCRIPTION	MIN	TYP	MAX	UNIT
t <sub>A</sub>	Aperture delay	0.5	0.7	1.1	ns
	Aperture delay matching	Between two channels of the same device		±70	ps
	Variation of aperture delay	Between two devices at the same temperature and supply voltage.		±150	ps
t <sub>J</sub>	Aperture jitter		85		f <sub>S</sub> rms
Wakeup time	Time to valid data after coming out of STANDBY mode		50	100	μs
	Time to valid data after coming out of GLOBAL power-down mode (in this mode, both channels power-down)		250	1000	μs
ADC latency <sup>(1)</sup>	Default latency after reset		14		Clock cycles
	Normal OVR latency		14		Clock cycles
	Fast OVR latency		9		Clock cycles
t <sub>SU_SYNCIN</sub>	Setup time for SYNCIN Referenced to input clock rising edge	400			ps
t <sub>H_SYNCIN</sub>	Hold time for SYNCIN Referenced to input clock rising edge	100			ps

(1) Overall latency = ADC latency + t<sub>PD1</sub>.

### TIMING DIAGRAM: General

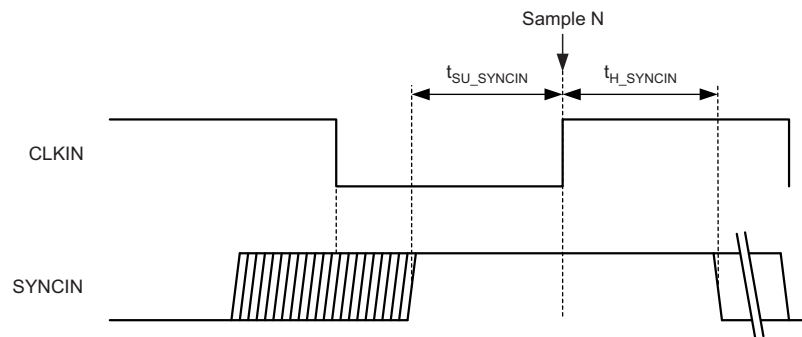

Figure 1. Timing Diagram for SYNCINP and SYNCINM Inputs

**TIMING REQUIREMENTS: DDR LVDS Mode<sup>(1)</sup>**

Typical values are at +25°C, AVDD = 1.8 V, AVDD3V = 3.3 V, DRVDD = 1.8 V, sampling frequency = 250 MSPS, sine wave input clock, C<sub>LOAD</sub> = 3.3 pF, and R<sub>LOAD</sub> = 100 Ω, unless otherwise noted. Minimum and maximum values are across the full temperature range: T<sub>MIN</sub> = -40°C to T<sub>MAX</sub> = +85°C, AVDD = 1.8 V, AVDD3V = 3.3 V, and DRVDD = 1.7 V to 1.9 V.

PARAMETER		DESCRIPTION	MIN	TYP	MAX	UNIT
t <sub>SU</sub>	Data setup time	Data valid to zero-crossing of differential output clock (CLKOUTP – CLKOUTM) <sup>(2)</sup>	0.62	0.82		ns
t <sub>HO</sub>	Data hold time	Zero-crossing of differential output clock (CLKOUTP – CLKOUTM) to data becoming invalid <sup>(2)</sup>	0.54	0.64		ns
t <sub>PDI</sub>	Clock propagation delay	Input clock rising edge cross-over to output clock (CLKOUTP – CLKOUTM) rising edge cross-over	8	10.5	13	ns
	LVDS bit clock duty cycle	Duty cycle of differential clock (CLKOUTP – CLKOUTM)		52		%
t <sub>FALL</sub> , t <sub>RISE</sub>	Data fall time, Data rise time	Rise time measured from -100 mV to +100 mV 10 MSPS ≤ Sampling frequency ≤ 250 MSPS		0.14		ns
t <sub>CLKRISE</sub> , t <sub>CLKFALL</sub>	Output clock rise time, Output clock fall time	Rise time measured from -100 mV to +100 mV 10 MSPS ≤ Sampling frequency ≤ 250 MSPS		0.18		ns

- (1) Measurements are done with a transmission line of a 100-Ω characteristic impedance between the device and load. Setup and hold time specifications take into account the effect of jitter on the output data and clock.
- (2) Data valid refers to a logic high of +100 mV and a logic low of -100 mV.

**Table 3. DDR LVDS Timings at Lower Sampling Frequencies**

SAMPLING FREQUENCY (MSPS)	SETUP TIME (ns)			HOLD TIME (ns)			CLOCK PROPAGATION DELAY (ns)		
	t <sub>SU</sub>			t <sub>HO</sub>			t <sub>PDI</sub>		
	MIN	TYP	MAX	MIN	TYP	MAX	MIN	TYP	MAX
80	2.40	2.96		2.16	2.82		9	11.9	15
120	1.57	1.92		1.40	1.84		8	11.1	14
160	1.17	1.40		1.02	1.36		8	10.6	13
200	0.82	1.07		0.72	1.02		8	10.5	13
230	0.69	0.91		0.61	0.84		8	10.5	13

TIMING DIAGRAM: DDR LVDS Mode

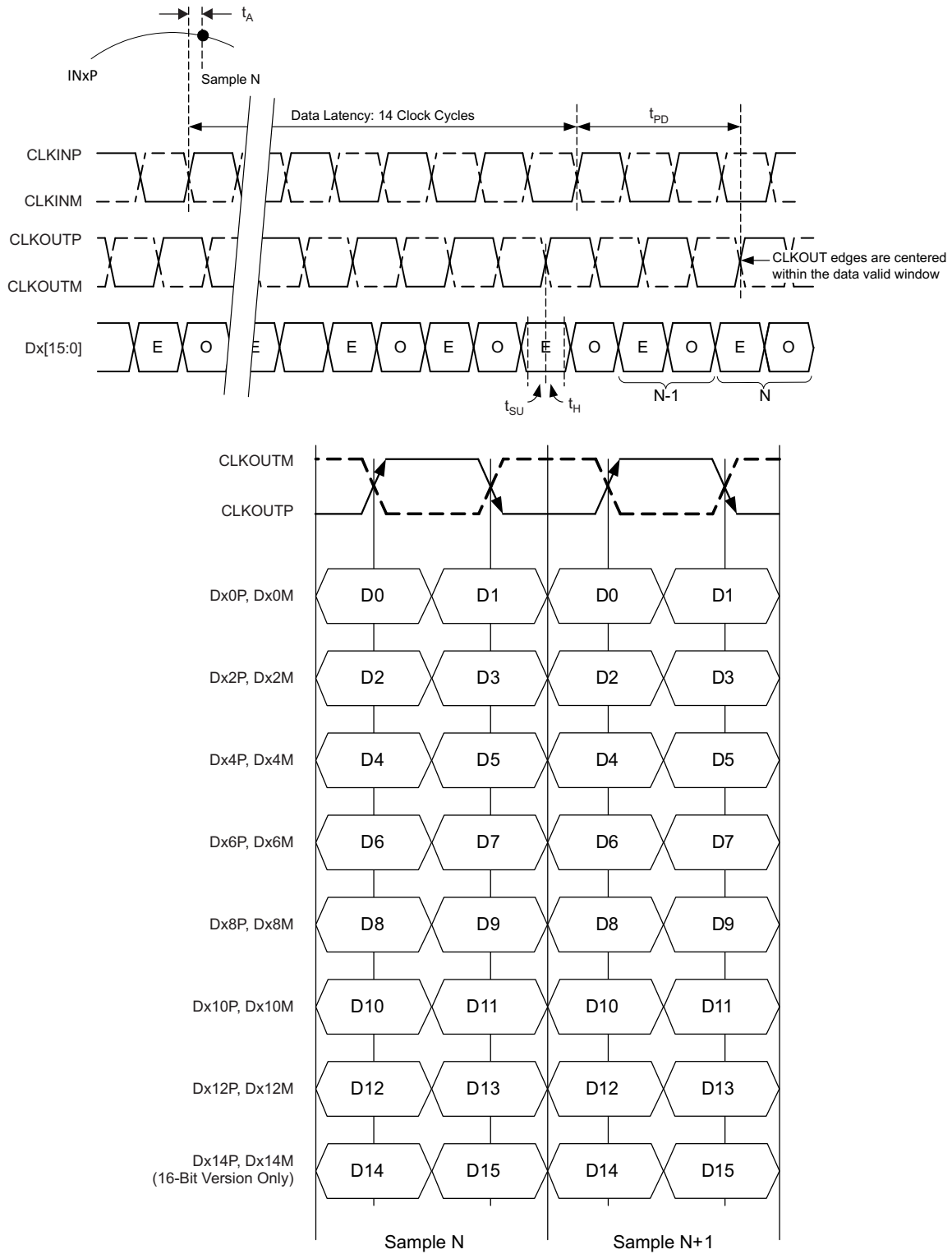

Figure 2. DDR LVDS Output Timing Diagram

**TIMING REQUIREMENTS: QDR LVDS Mode<sup>(1)(2)</sup>**

Typical values are at +25°C, AVDD = 1.8 V, AVDD3V = 3.3 V, DRVDD = 1.8 V, sampling frequency = 250 MSPS, sine-wave input clock, C<sub>LOAD</sub> = 3.3 pF<sup>(3)</sup>, and R<sub>LOAD</sub> = 100 Ω<sup>(4)</sup>, unless otherwise noted. Minimum and maximum values are across the full temperature range of T<sub>MIN</sub> = -40°C to T<sub>MAX</sub> = +85°C, AVDD = 1.8 V, AVDD3V = 3.3 V, and DRVDD = 1.7 V to 1.9 V.

PARAMETER	TEST CONDITIONS	MIN	TYP	MAX	UNIT
t <sub>SU</sub> Data setup time <sup>(5)(6)</sup>	Data valid to DxCLKP, DxCLKM zero-crossing	0.23	0.31		ns
t <sub>H</sub> Data hold time <sup>(5)(6)</sup>	DxCLKP, DxCLKM zero-crossing to data becoming invalid	0.16	0.29		ns
	LVDS bit clock duty cycle		50%		
t <sub>PDI</sub> Clock propagation delay	Input clock rising edge cross-over to output frame clock (DxFRAMEP-DxFRAMEM) rising edge cross-over	7	10.1	13	ns
t <sub>RISE</sub> , t <sub>FALL</sub> Data rise and fall time	Rise time measured from -100 mV to +100 mV		0.18		ns
t <sub>CLKRISE</sub> , t <sub>CLKFALL</sub> Output clock rise and fall time	Rise time measured from -100 mV to +100 mV		0.2		ns

- (1) Measurements are done with a transmission line of 100-Ω characteristic impedance between the device and load. Setup and hold time specifications take into account the effect of jitter on the output data and clock.
- (2) Timing parameters are ensured by design and characterization and are not tested in production.
- (3) C<sub>LOAD</sub> is the effective external single-ended load capacitance between each output pin and ground.
- (4) R<sub>LOAD</sub> is the differential load resistance between the LVDS output pair.
- (5) Data valid refers to a logic high of +100 mV and a logic low of -100 mV.
- (6) The setup and hold times of a channel are measured with respect to the same channel output clock.

**Table 4. QDR LVDS Timings at Lower Sampling Frequencies**

SAMPLING FREQUENCY (MSPS)	SETUP TIME (ns)			HOLD TIME (ns)			CLOCK PROPAGATION DELAY (ns)		
	t <sub>SU</sub>			t <sub>HO</sub>			t <sub>PDI</sub>		
	MIN	TYP	MAX	MIN	TYP	MAX	MIN	TYP	MAX
80	1.06	1.21		0.84	1.29		6	9.3	12
120	0.63	0.77		0.66	0.88		7	9.5	13
160	0.43	0.55		0.39	0.61		7	9.7	13
200	0.31	0.42		0.28	0.47		7	9.8	13
230	0.24	0.34		0.17	0.36		7	9.9	13

TIMING DIAGRAM: QDR LVDS Mode

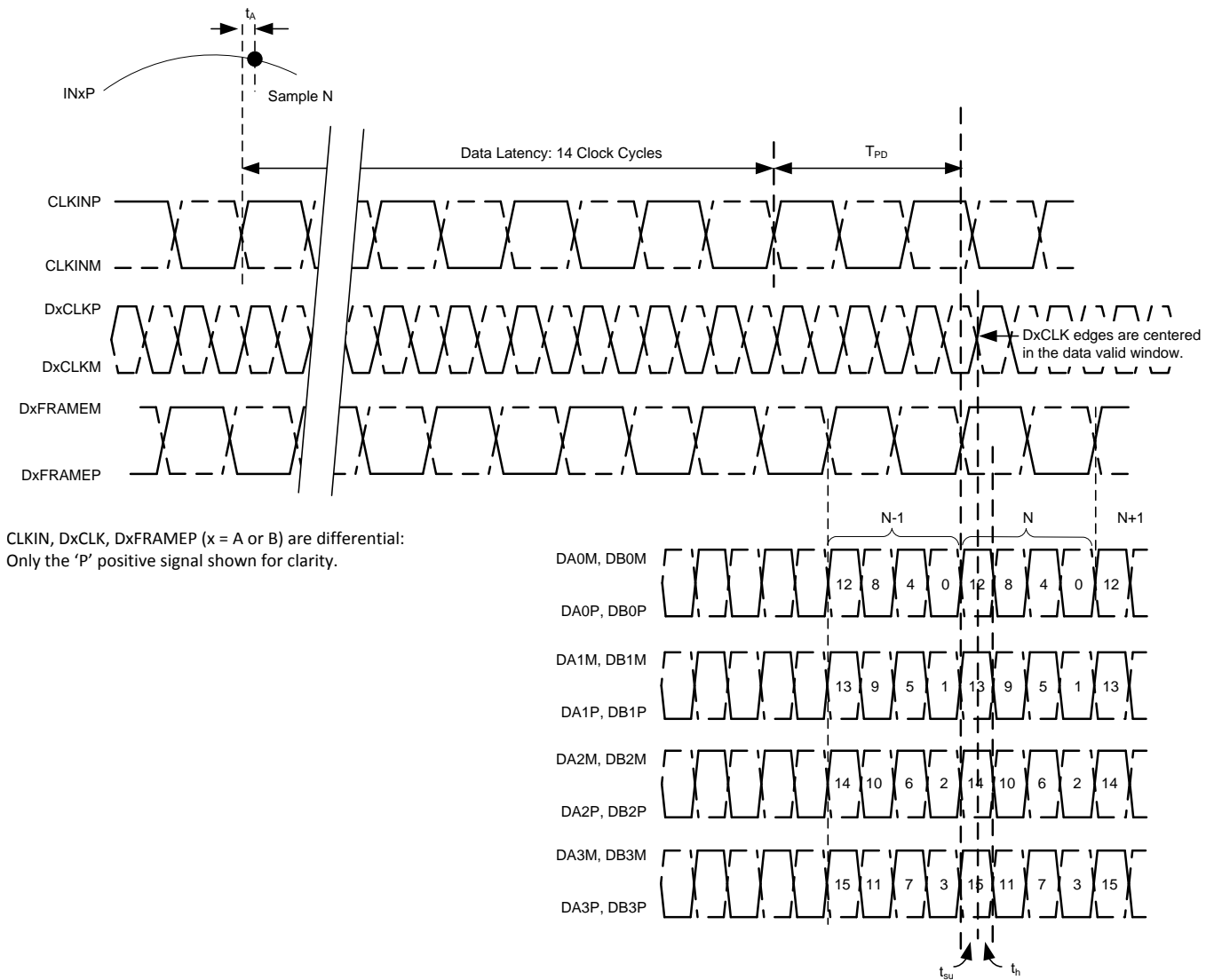

Figure 3. QDR LVDS Output Timing Diagram

## DIGITAL CHARACTERISTICS

The dc specifications refer to the condition where the digital outputs are not switching, but are permanently at a valid logic level '0' or '1'. AVDD = 1.8 V, AVDD3V = 3.3 V, DRVDD = 1.8 V, and, unless otherwise noted.

PARAMETER		TEST CONDITIONS	MIN	TYP	MAX	UNIT
<b>DIGITAL INPUTS (RESET, SCLK, SDATA, SEN, CTRL1, CTRL2)<sup>(1)</sup></b>						
V <sub>IH</sub>	High-level input voltage	All digital inputs support 1.8-V and 3.3-V CMOS logic levels	1.3			V
V <sub>IL</sub>	Low-level input voltage				0.4	V
I <sub>IH</sub>	High-level input current	RESET, SDATA, SCLK, CTRL1, CTRL2 <sup>(2)</sup>	V <sub>HIGH</sub> = 1.8 V	10		μA
		SEN <sup>(3)</sup>	V <sub>HIGH</sub> = 1.8 V	0		μA
I <sub>IL</sub>	Low-level input current	RESET, SDATA, SCLK, CTRL1, CTRL2	V <sub>LOW</sub> = 0 V	0		μA
		SEN	V <sub>LOW</sub> = 0 V	10		μA
<b>DIGITAL OUTPUTS, CMOS INTERFACE (OVRA, OVRB, SDOUT)</b>						
V <sub>OH</sub>	High-level output voltage		DRVDD – 0.1	DRVDD		V
V <sub>OL</sub>	Low-level output voltage			0	0.1	V
<b>DIGITAL OUTPUTS, LVDS INTERFACE</b>						
V <sub>ODH</sub>	High-level output differential voltage	With an external 100-Ω termination	250	350	500	mV
V <sub>ODL</sub>	Low-level output differential voltage	With an external 100-Ω termination	–500	–350	–250	mV
V <sub>OCM</sub>	Output common-mode voltage			1.05		V

- (1) SCLK, SDATA, and SEN function as digital input pins in serial configuration mode.
- (2) SDATA and SCLK have an internal 150-kΩ pull-down resistor.
- (3) SEN has an internal 150-kΩ pull-up resistor to AVDD. Because the pull-up resistor is weak, SEN can also be driven by 1.8-V or 3.3-V CMOS buffers.

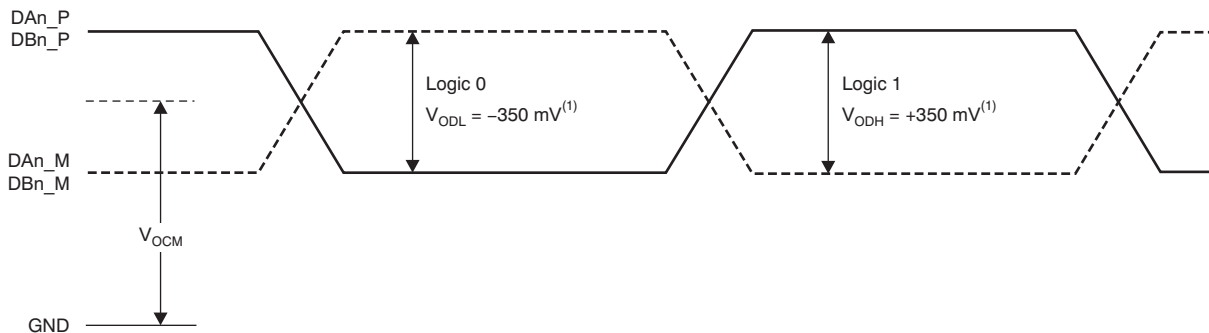

- (1) With an external 100-Ω termination.

Figure 4. DDR LVDS Output Voltage Levels

## PIN CONFIGURATIONS

### RGC PACKAGE QFN-64 (Top View)

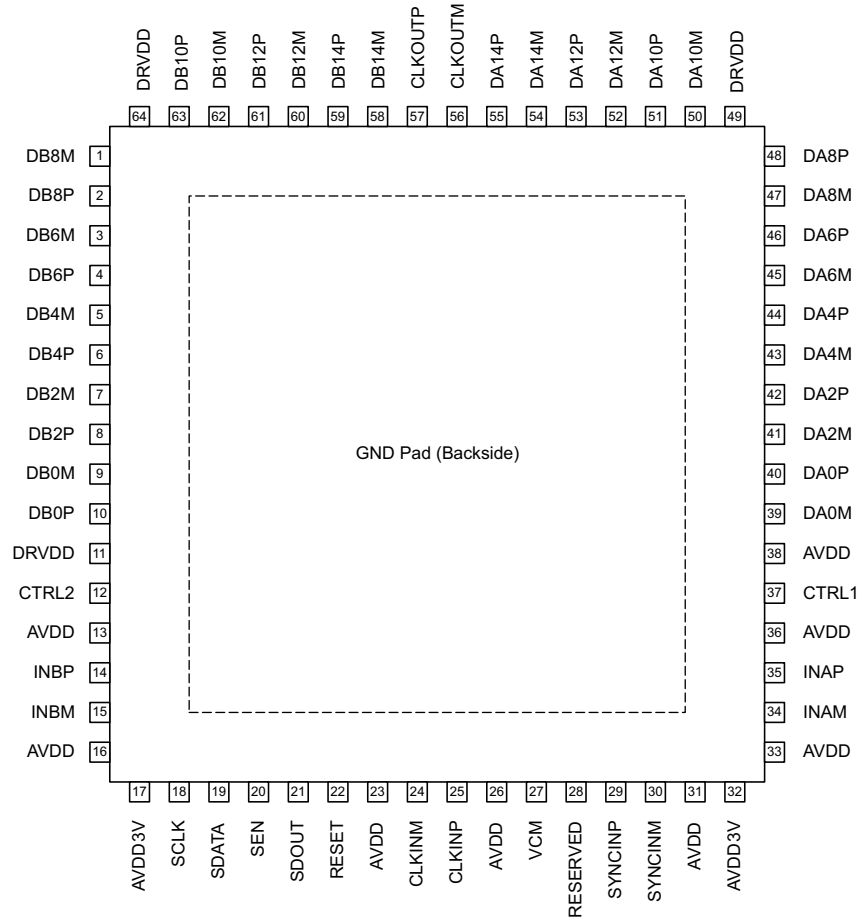
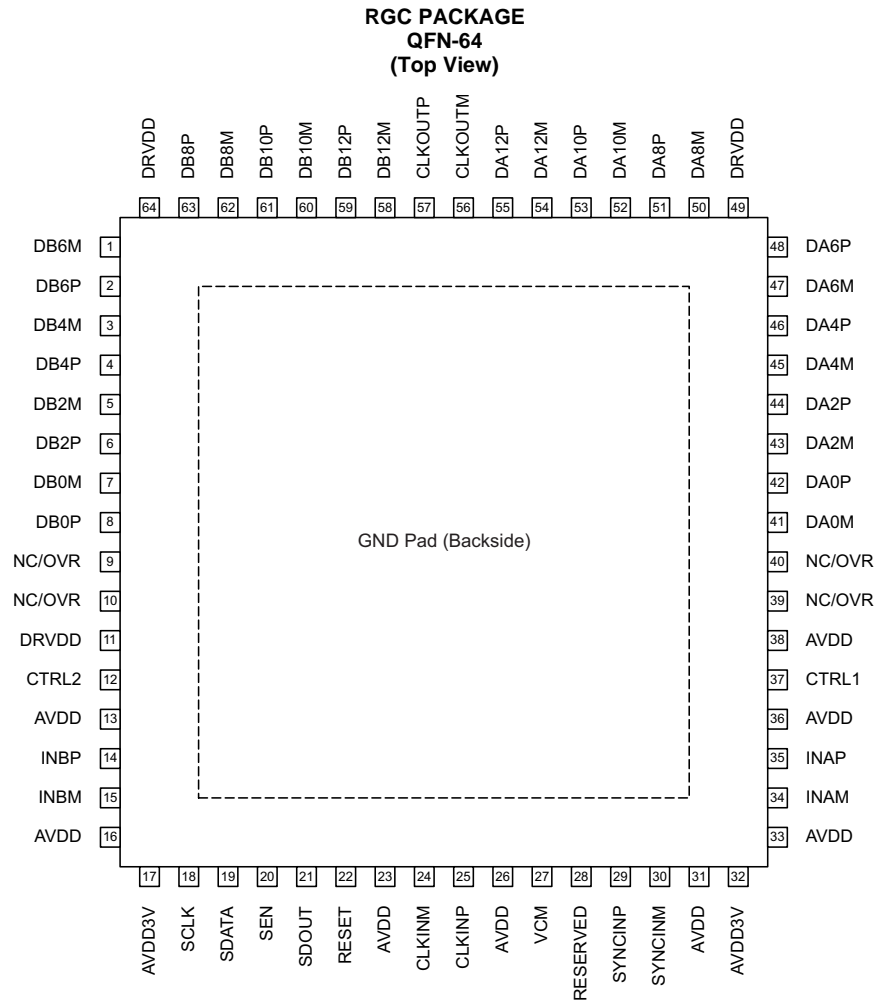

Figure 5. ADS42LB69 DDR LVDS

**PIN ASSIGNMENTS: ADS42LB69 DDR LVDS OUTPUT INTERFACE**

PIN		I/O	DESCRIPTION
NAME	NUMBER		
<b>INPUT AND REFERENCE</b>			
INAP, INAM	36, 35	I	Differential analog input for channel A
INBP, INBM	14, 15	I	Differential analog input for channel B
VCM	27	O	Common-mode voltage for analog inputs, 1.9 V
<b>CLOCK AND SYNC</b>			
CLKINP, CLKINM	25, 24	I	Differential clock input for ADC
SYNCINP, SYNCINM	29, 30	I	External sync input. If not used, connect SYNCINP to GND and SYNCINM to AVDD.
<b>CONTROL AND SERIAL</b>			
CTRL1	37	I/O	Can be configured as power-down input pin or as OVR output pin for channel A, depending on the register bit PDN/OVR FOR CTRL PINS.
CTRL2	12	I/O	Can be configured as power-down input pin or as OVR output pin for channel B, depending on the register bit PDN/OVR FOR CTRL PINS
Reserved	28	—	Do not connect
RESET	22	I	Hardware reset. Active high.
SCLK	18	I	Serial interface clock input
SDATA	19	I	Serial interface data input.
SDOUT	21	O	Serial interface data output
SEN	20	I	Serial interface enable
<b>DATA INTERFACE</b>			
CLKOUTP, CLKOUTM	57, 56	O	Differential LVDS output clock
DA[14:0]P, DA[14:0]M	39-48, 50-55	O	DDR LVDS output interface for channel A
DB[14:0]P, DB[14:0]M	1-10, 58-63	O	DDR LVDS output interface for channel B
<b>POWER SUPPLY</b>			
AVDD	13, 16, 23, 26, 31, 33, 36, 38	I	Analog 1.8-V power supply
AVDD3V	17, 32	I	Analog 3.3 V power supply for analog buffer
DRVDD	11, 49, 64	I	Digital 1.8-V power supply
GND	Ground pad	I	Ground



**Figure 6. ADS42LB49 DDR LVDS**

**PIN ASSIGNMENTS: ADS42LB49 DDR LVDS OUTPUT INTERFACE**

PIN		I/O	DESCRIPTION
NAME	NUMBER		
<b>INPUT AND REFERENCE</b>			
INAP, INAM	35, 35	I	Differential analog input for channel A
INBP, INBM	14, 15	I	Differential analog input for channel B
VCM	27	O	Common-mode voltage for analog inputs, 1.9 V
<b>CLOCK AND SYNC</b>			
CLKINP, CLKINM	25, 24	I	Differential clock input for ADC
SYNCINP, SYNCINM	29, 30	I	External sync input. If not used, connect SYNCINP to GND and SYNCINM to AVDD.
<b>CONTROL AND SERIAL</b>			
CTRL1	37	I/O	Can be configured as power-down input pin or as OVR output pin for channel A, depending on the register bit PDN/OVR FOR CTRL PINS.
CTRL2	12	I/O	Can be configured as power-down input pin or as OVR output pin for channel B, depending on the register bit PDN/OVR FOR CTRL PINS
NC/OVR	9, 10, 39, 40	—	If the OVR ON LSB bit is set, these pins can be used because they carry overrange information. Otherwise, do not connect these pins.
Reserved	28	—	Do not connect
RESET	22	I	Hardware reset. Active high.
SCLK	18	I	Serial interface clock input
SDATA	19	I	Serial interface data input.
SDOUT	21	O	Serial interface data output
SEN	20	I	Serial interface enable
<b>DATA INTERFACE</b>			
CLKOUTP, CLKOUTM	57, 56	O	Differential LVDS output clock
DA[14:0]P, DA[14:0]M	41-48, 50-55	O	DDR LVDS output interface for channel A
DB[14:0]P, DB[14:0]M	1-8, 58-63	O	DDR LVDS output interface for channel B
<b>POWER SUPPLY</b>			
AVDD	13, 16, 23, 26, 31, 33, 36, 38	I	Analog 1.8-V power supply
AVDD3V	17, 32	I	Analog 3.3-V analog supply for analog buffer
DRVDD	11, 49, 64	I	Digital 1.8-V power supply
GND	Ground pad	I	Ground

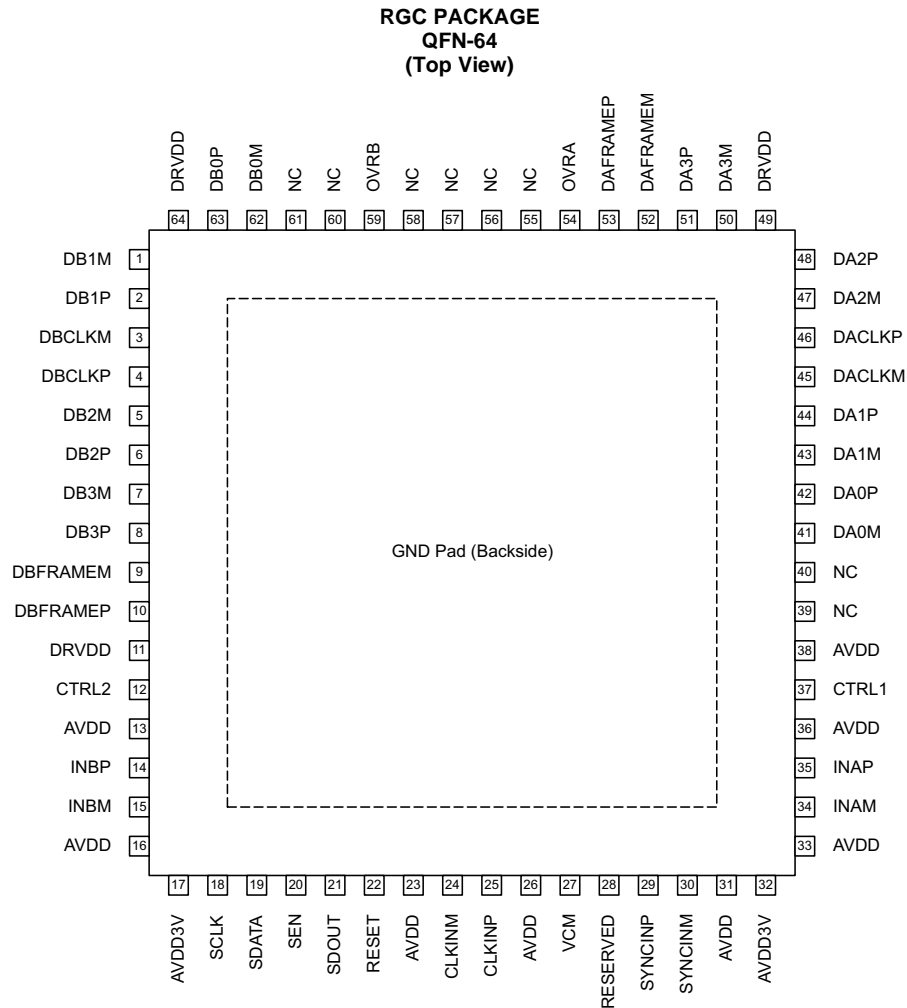

**Figure 7. ADS42LB69, ADS42LB49 QDR LVDS**

**PIN ASSIGNMENTS: QDR LVDS OUTPUT INTERFACE**

PIN		I/O	DESCRIPTION
NAME	NUMBER		
<b>INPUT AND REFERENCE</b>			
INAP, INAM	34, 35	I	Differential analog input for channel A
INBP, INBM	14, 15	I	Differential analog input for channel B
VCM	27	O	Common-mode voltage for analog inputs, 1.9 V
<b>CLOCK AND SYNC</b>			
CLKINP, CLKINM	24, 25	I	Differential clock input for ADC
SYNCINP, SYNCINM	29, 30	I	External sync input If not used, connect SYNCINP to GND and SYNCINM to AVDD.
<b>CONTROL AND SERIAL</b>			
CTRL1	37	I	Can be configured as power-down input pin or as OVR output pin for channel A, depending on the register bit PDN/OVR FOR CTRL PINS.
CTRL2	12	I	Can be configured as power-down input pin or as OVR output pin for channel B, depending on the register bit PDN/OVR FOR CTRL PINS
NC	39, 40, 55-58, 60, 61	—	Do not connect
Reserved	28	—	Do not connect
RESET	22	I	Hardware reset. Active high.
SCLK	18	I	Serial interface clock input
SDATA	19	I	Serial interface data input.
SDOUT	21	O	Serial interface data output
SEN	20	I	Serial interface enable
<b>DATA INTERFACE</b>			
DA[3:0]P, DA[3:0]M	41-44, 47, 48, 50, 51	O	4-bit QDR LVDS output interface for channel A
DACLKP, DACLKM	45, 46	O	Differential output clock for channel A
DAFRAMEP, DAFRAMEM	52, 53	—	Differential frame clock output for channel A
DB[3:0]P, DB[3:0]M	1, 2, 5-8, 62, 63	—	4-bit QDR LVDS output interface for channel B
DBCLKP, DBCLKM	3, 4	—	Differential output clock for channel A
DBFRAMEP, DBFRAMEM	9, 10	—	Differential frame clock output for channel A
OVRA	54	O	Overrange indication channel A
OVRB	59	O	Overrange indication channel A
<b>POWER SUPPLY</b>			
AVDD	13, 16, 23, 26, 31, 33, 36, 38	I	Analog 1.8-V power supply
AVDD3V	17, 32	I	Analog 3.3-V power supply for analog buffer
DRVDD	11, 49, 64	I	Digital 1.8-V power supply
GND	Ground pad	I	Ground

FUNCTIONAL BLOCK DIAGRAMS

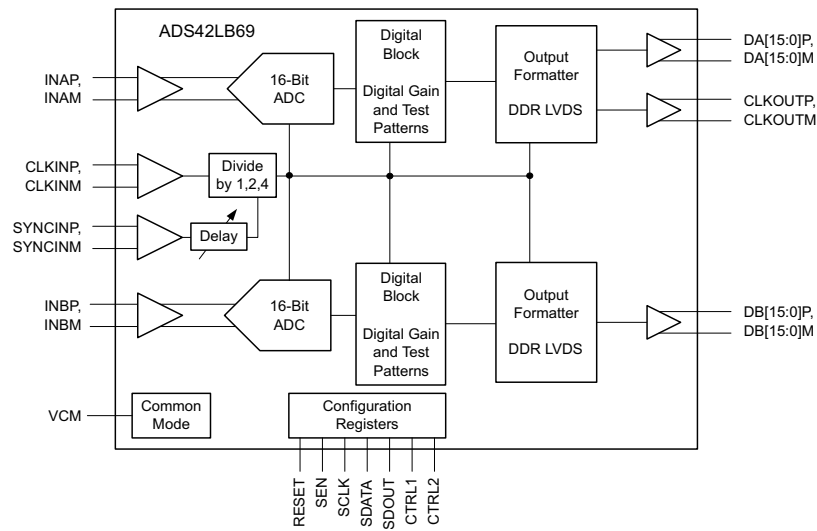

Figure 8. ADS42LB69 DDR LVDS

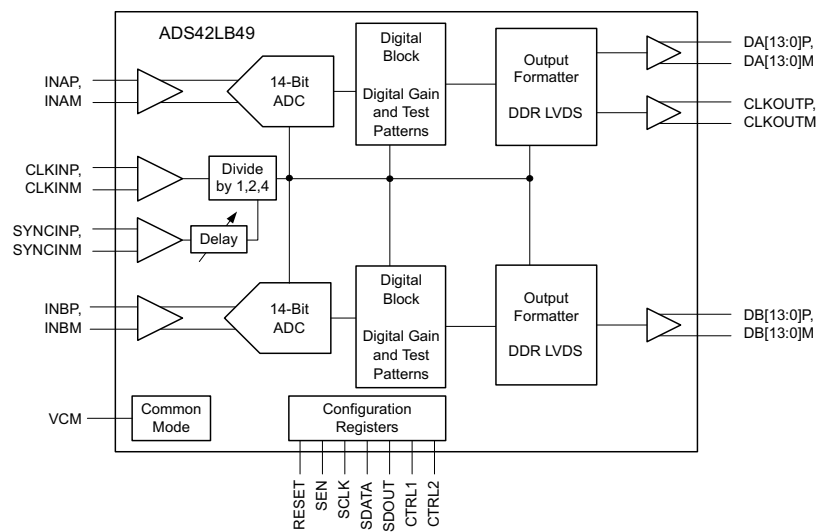

Figure 9. ADS42LB49 DDR LVDS

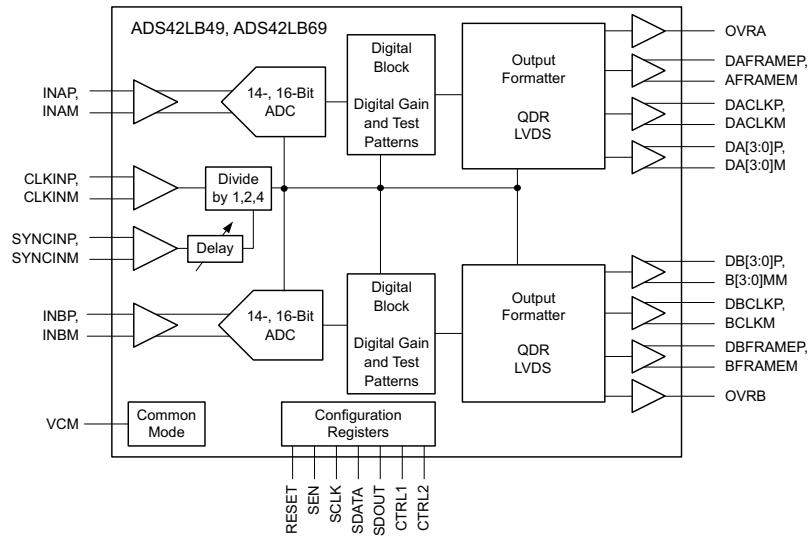

Figure 10. ADS42LB69, ADS42LB49 QDR LVDS

### TYPICAL CHARACTERISTICS: ADS42LB69

Typical values are at  $T_A = +25^\circ\text{C}$ , full temperature range is  $T_{\text{MIN}} = -40^\circ\text{C}$  to  $T_{\text{MAX}} = +85^\circ\text{C}$ , ADC sampling rate = 250 MSPS, 50% clock duty cycle, QDR interface, AVDD3V = 3.3 V, AVDD = DRVDD = 1.8 V, -1-dBFS differential input, and 32k-point FFT, unless otherwise noted.

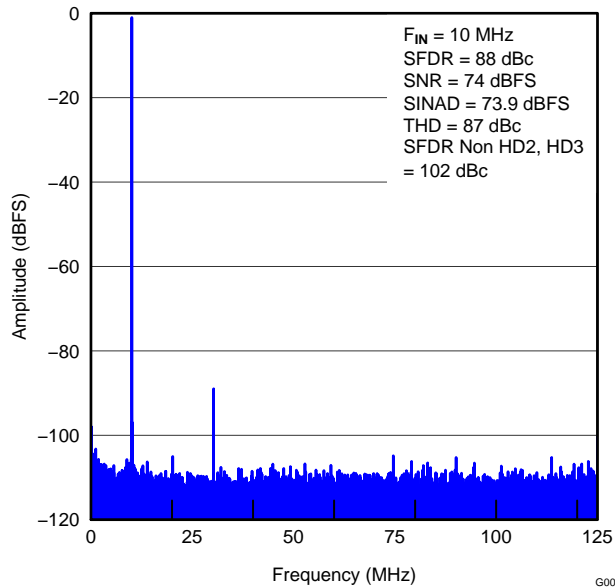

Figure 11. FFT FOR 10-MHz INPUT SIGNAL

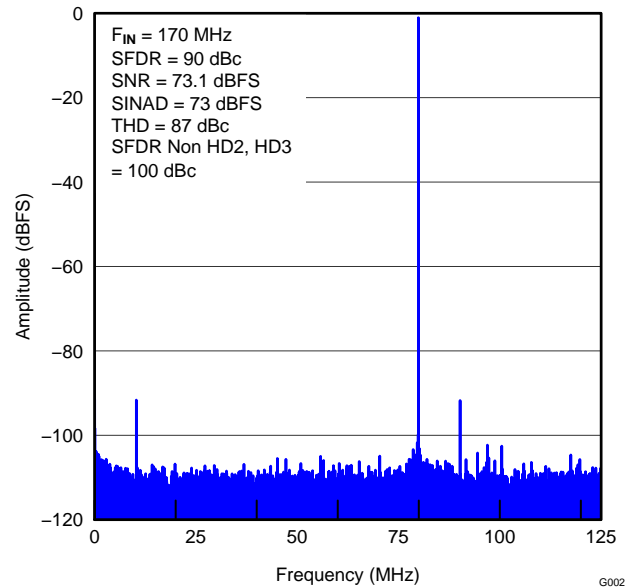

Figure 12. FFT FOR 170-MHz INPUT SIGNAL

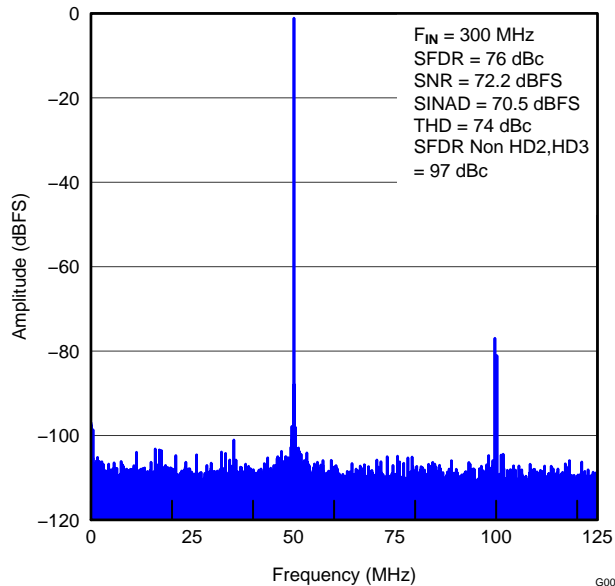

Figure 13. FFT FOR 300-MHz INPUT SIGNAL

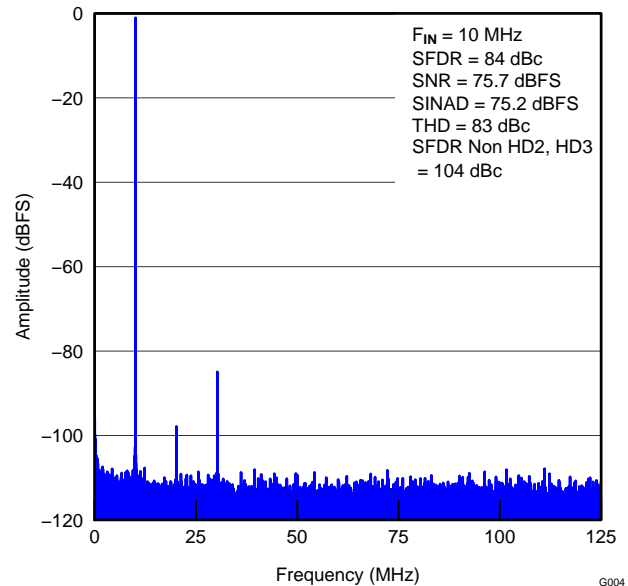
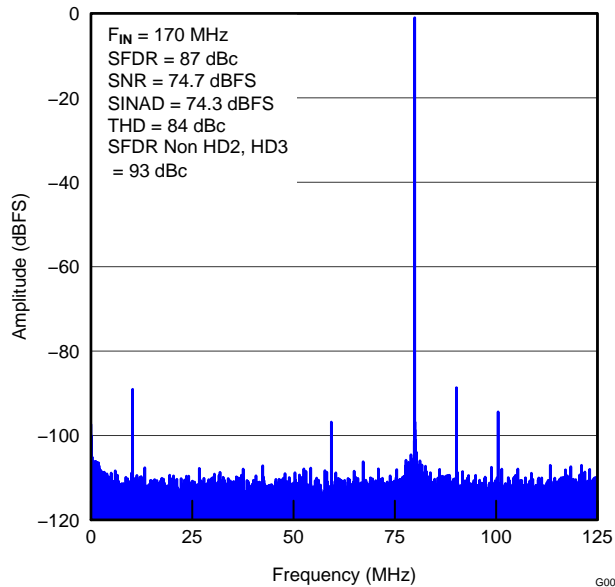

Figure 14. FFT FOR 10-MHz INPUT SIGNAL (2.5-V<sub>PP</sub> Full-Scale)

**TYPICAL CHARACTERISTICS: ADS42LB69 (continued)**

Typical values are at  $T_A = +25^\circ\text{C}$ , full temperature range is  $T_{\text{MIN}} = -40^\circ\text{C}$  to  $T_{\text{MAX}} = +85^\circ\text{C}$ , ADC sampling rate = 250 MSPS, 50% clock duty cycle, QDR interface,  $\text{AVDD3V} = 3.3\text{ V}$ ,  $\text{AVDD} = \text{DRVDD} = 1.8\text{ V}$ ,  $-1\text{-dBFS}$  differential input, and 32k-point FFT, unless otherwise noted.



**Figure 15. FFT FOR 170-MHz INPUT SIGNAL (2.5-V<sub>PP</sub> Full-Scale)**

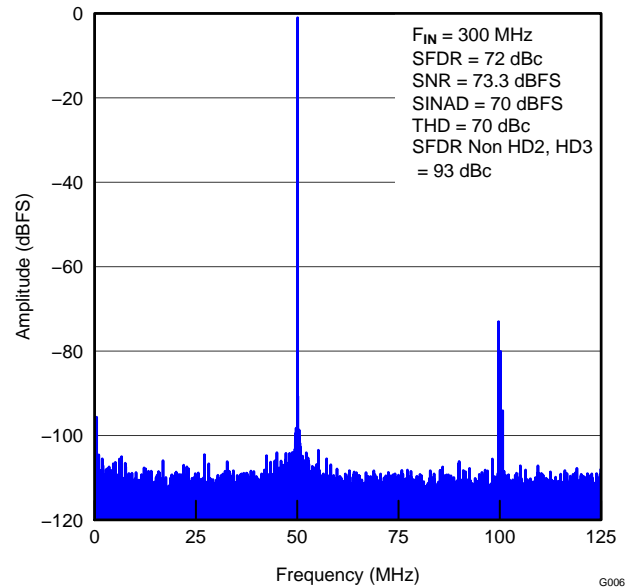

**Figure 16. FFT FOR 300-MHz INPUT SIGNAL (2.5-V<sub>PP</sub> Full-Scale)**

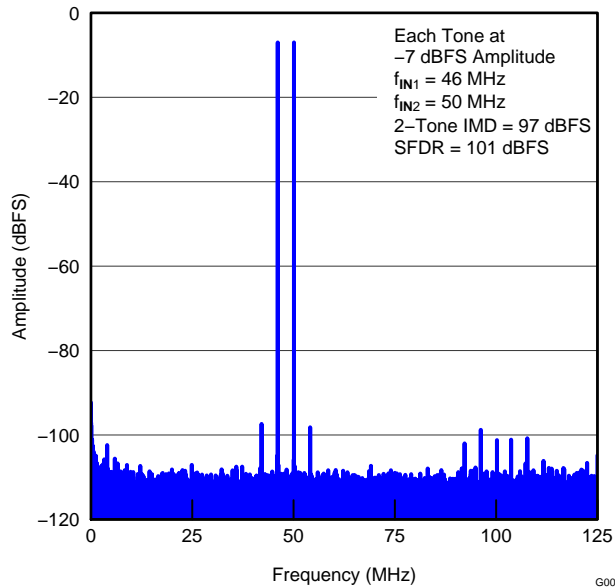

**Figure 17. FFT FOR TWO-TONE INPUT SIGNAL (At  $-7\text{ dBFS}$ , 46 MHz and 50 MHz)**

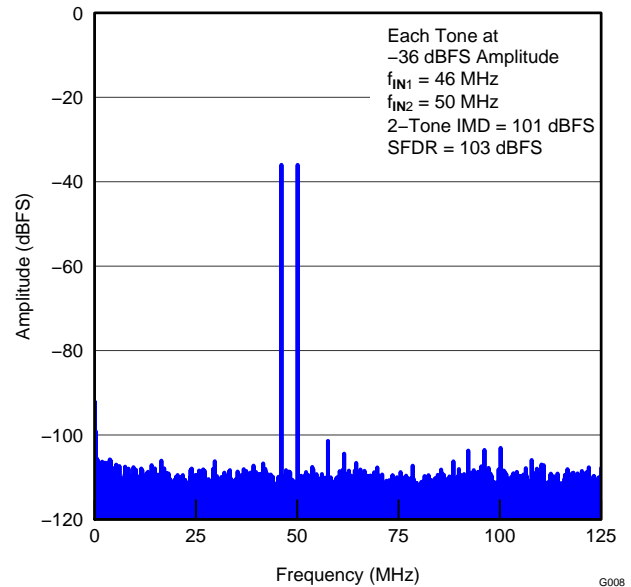

**Figure 18. FFT FOR TWO-TONE INPUT SIGNAL (At  $-36\text{ dBFS}$ , 46 MHz and 50 MHz)**

**TYPICAL CHARACTERISTICS: ADS42LB69 (continued)**

Typical values are at  $T_A = +25^\circ\text{C}$ , full temperature range is  $T_{\text{MIN}} = -40^\circ\text{C}$  to  $T_{\text{MAX}} = +85^\circ\text{C}$ , ADC sampling rate = 250 MSPS, 50% clock duty cycle, QDR interface, AVDD3V = 3.3 V, AVDD = DRVDD = 1.8 V, -1-dBFS differential input, and 32k-point FFT, unless otherwise noted.

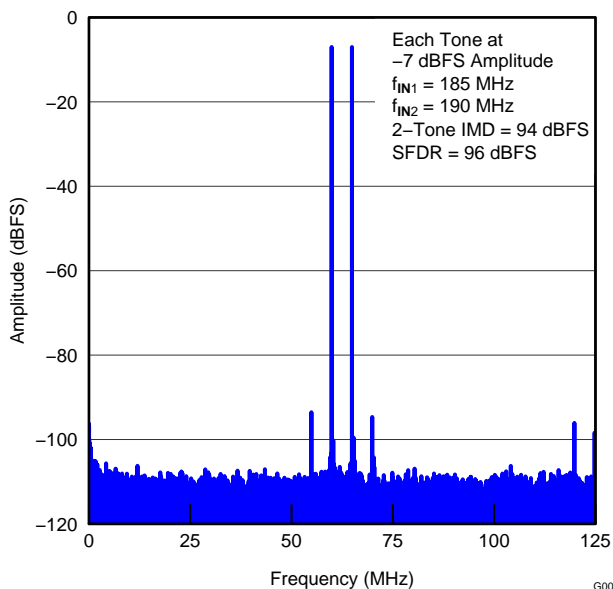

**Figure 19. FFT FOR TWO-TONE INPUT SIGNAL (At -7 dBFS, 185 MHz and 190 MHz)**

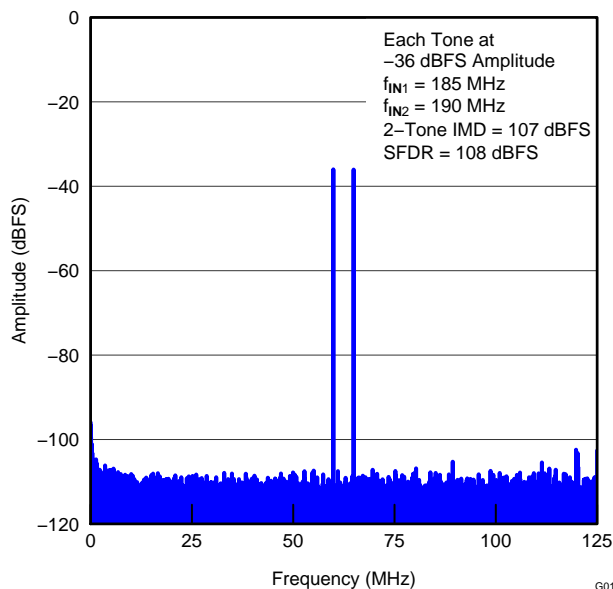

**Figure 20. FFT FOR TWO-TONE INPUT SIGNAL (At -36 dBFS, 185 MHz and 190 MHz)**

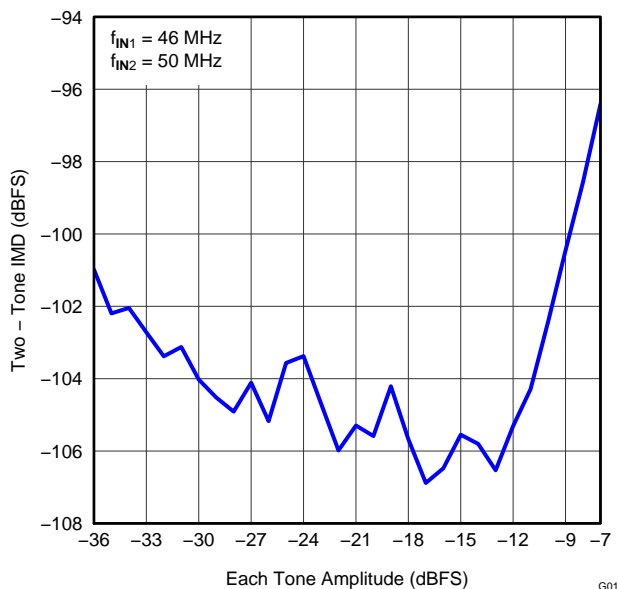

**Figure 21. IMD3 vs INPUT AMPLITUDE (46 MHz and 50 MHz)**

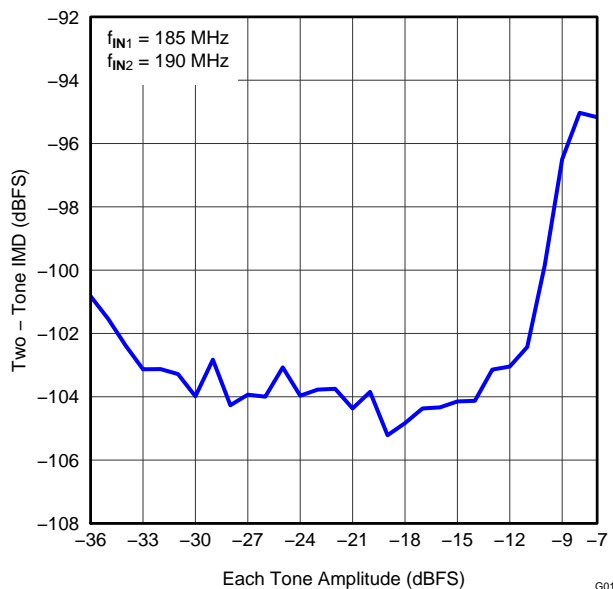

**Figure 22. IMD3 vs INPUT AMPLITUDE (185 MHz and 190 MHz)**

**TYPICAL CHARACTERISTICS: ADS42LB69 (continued)**

Typical values are at  $T_A = +25^\circ\text{C}$ , full temperature range is  $T_{\text{MIN}} = -40^\circ\text{C}$  to  $T_{\text{MAX}} = +85^\circ\text{C}$ , ADC sampling rate = 250 MSPS, 50% clock duty cycle, QDR interface, AVDD3V = 3.3 V, AVDD = DRVDD = 1.8 V, -1-dBFS differential input, and 32k-point FFT, unless otherwise noted.

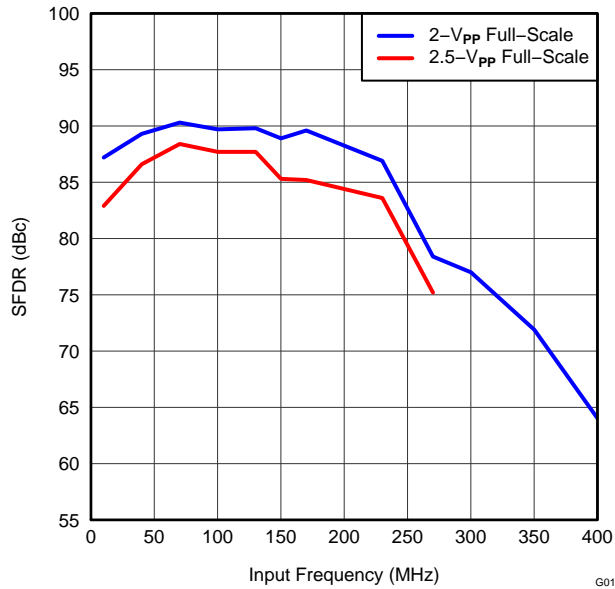

Figure 23. SFDR vs INPUT FREQUENCY

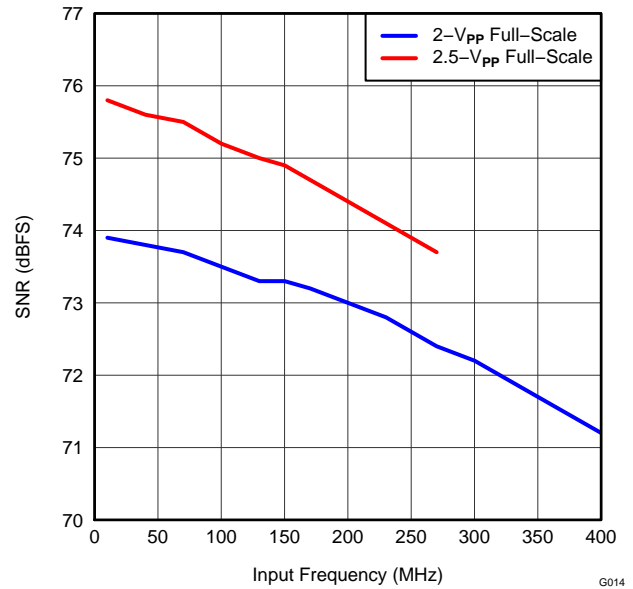

Figure 24. SNR vs INPUT FREQUENCY

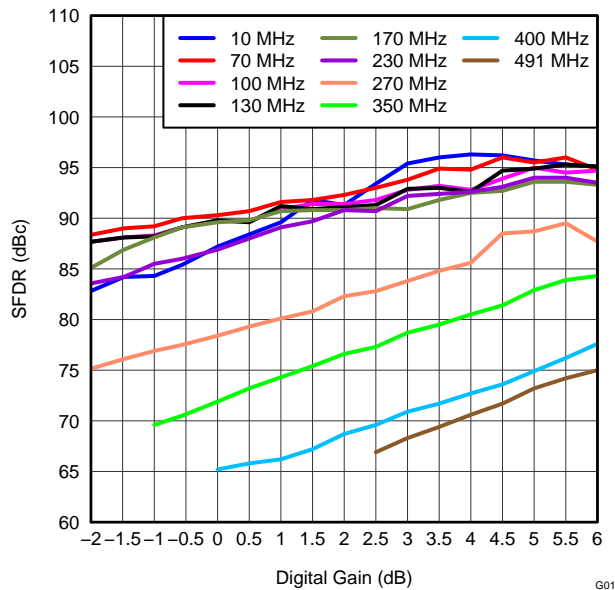

Figure 25. SFDR vs DIGITAL GAIN

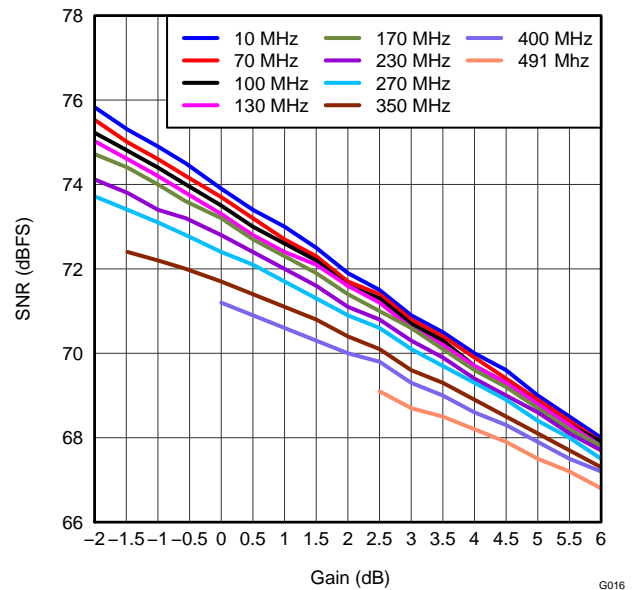
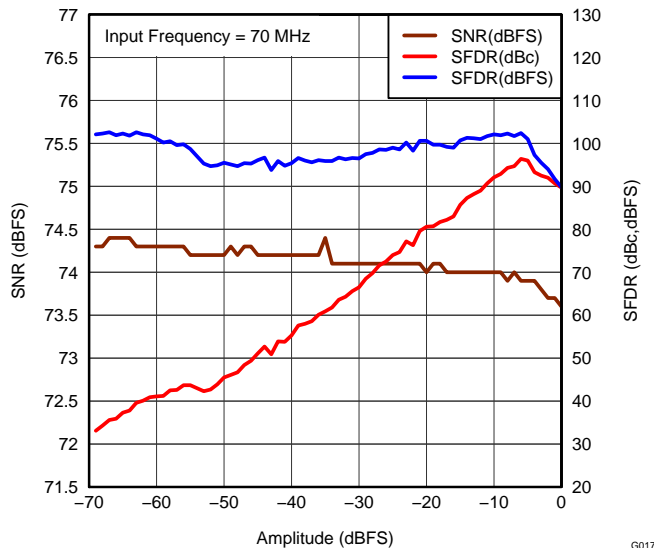

Figure 26. SNR vs DIGITAL GAIN

**TYPICAL CHARACTERISTICS: ADS42LB69 (continued)**

Typical values are at  $T_A = +25^\circ\text{C}$ , full temperature range is  $T_{\text{MIN}} = -40^\circ\text{C}$  to  $T_{\text{MAX}} = +85^\circ\text{C}$ , ADC sampling rate = 250 MSPS, 50% clock duty cycle, QDR interface, AVDD3V = 3.3 V, AVDD = DRVDD = 1.8 V, -1-dBFS differential input, and 32k-point FFT, unless otherwise noted.



**Figure 27. PERFORMANCE ACROSS INPUT AMPLITUDE (70 MHz)**

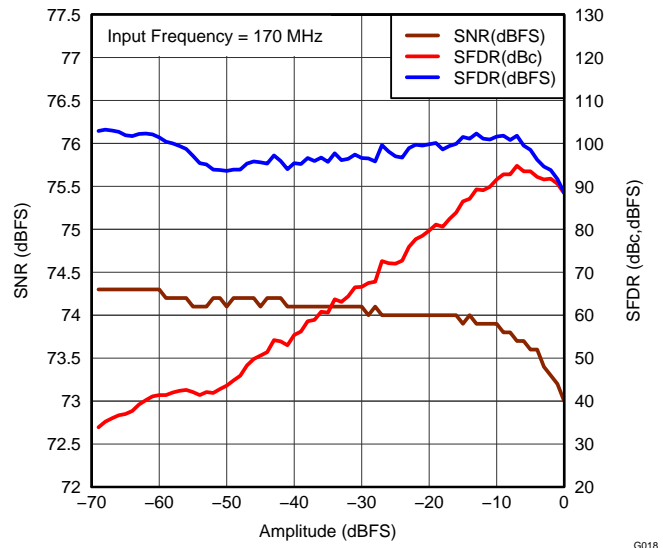

**Figure 28. PERFORMANCE ACROSS INPUT AMPLITUDE (170 MHz)**

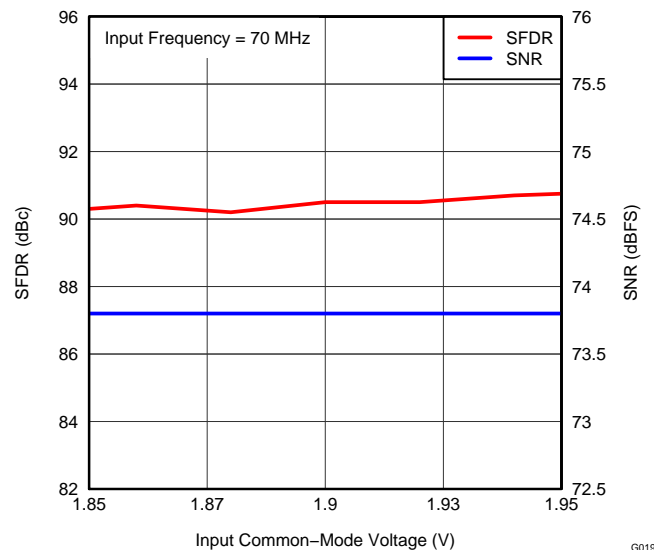

**Figure 29. PERFORMANCE vs INPUT COMMON-MODE VOLTAGE (70 MHz)**

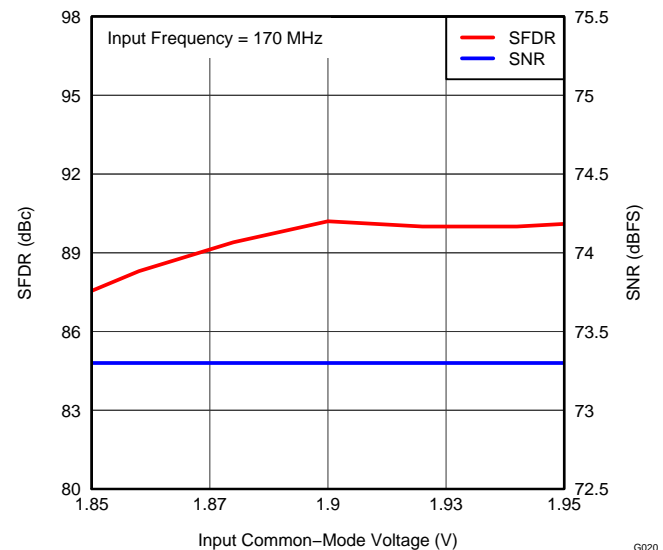

**Figure 30. PERFORMANCE vs INPUT COMMON-MODE VOLTAGE (170 MHz)**

**TYPICAL CHARACTERISTICS: ADS42LB69 (continued)**

Typical values are at  $T_A = +25^\circ\text{C}$ , full temperature range is  $T_{\text{MIN}} = -40^\circ\text{C}$  to  $T_{\text{MAX}} = +85^\circ\text{C}$ , ADC sampling rate = 250 MSPS, 50% clock duty cycle, QDR interface, AVDD3V = 3.3 V, AVDD = DRVDD = 1.8 V, -1-dBFS differential input, and 32k-point FFT, unless otherwise noted.

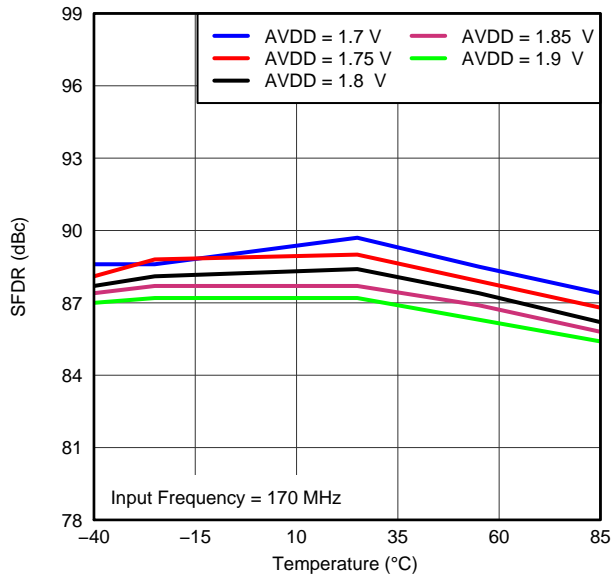

**Figure 31. SFDR vs AVDD SUPPLY AND TEMPERATURE (170 MHz)**

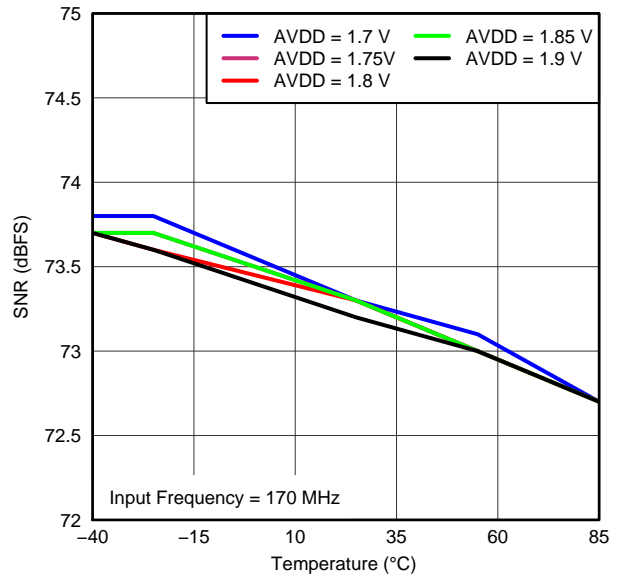

**Figure 32. SNR vs AVDD SUPPLY AND TEMPERATURE (170 MHz)**

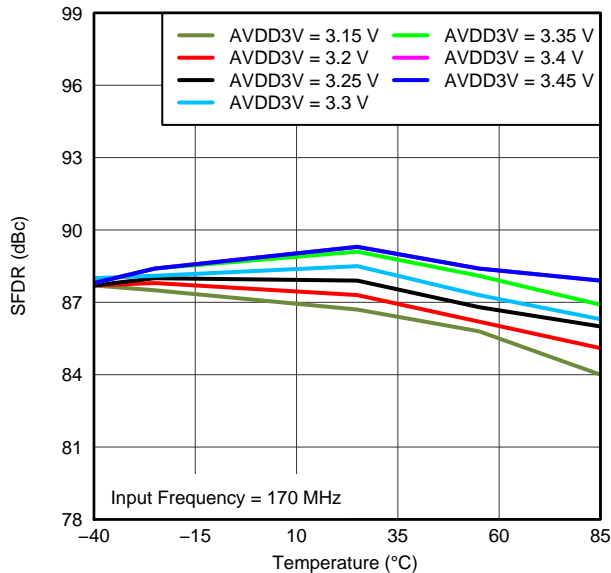

**Figure 33. SFDR vs AVDD\_BUF SUPPLY AND TEMPERATURE (170 MHz)**

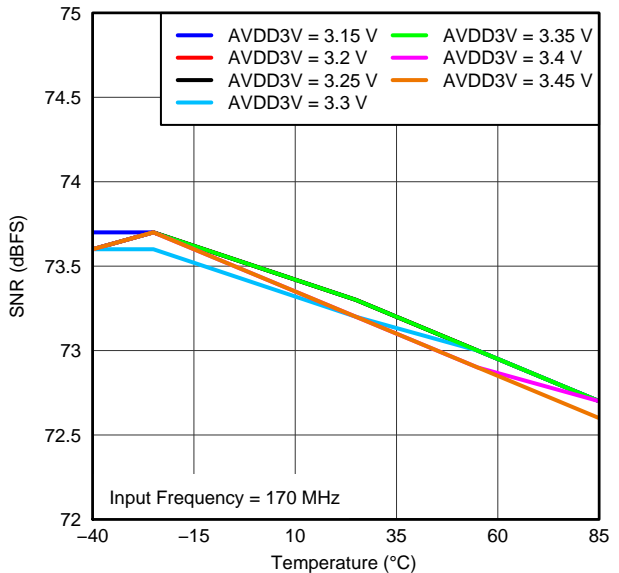

**Figure 34. SNR vs AVDD\_BUF SUPPLY AND TEMPERATURE (170 MHz)**

**TYPICAL CHARACTERISTICS: ADS42LB69 (continued)**

Typical values are at  $T_A = +25^\circ\text{C}$ , full temperature range is  $T_{\text{MIN}} = -40^\circ\text{C}$  to  $T_{\text{MAX}} = +85^\circ\text{C}$ , ADC sampling rate = 250 MSPS, 50% clock duty cycle, QDR interface, AVDD3V = 3.3 V, AVDD = DRVDD = 1.8 V, -1-dBFS differential input, and 32k-point FFT, unless otherwise noted.

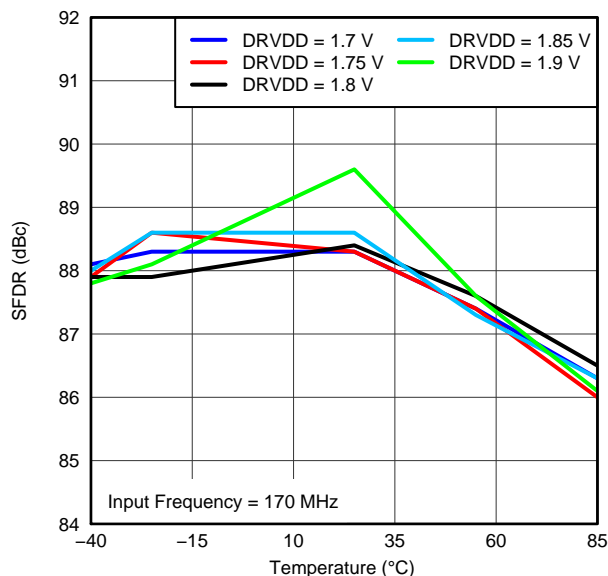

**Figure 35. SFDR vs DRVDD SUPPLY AND TEMPERATURE (170 MHz)**

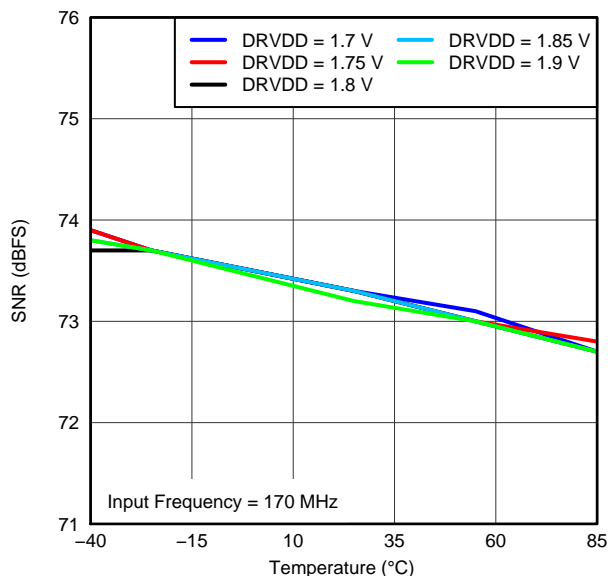

**Figure 36. SNR vs DRVDD SUPPLY AND TEMPERATURE (170 MHz)**

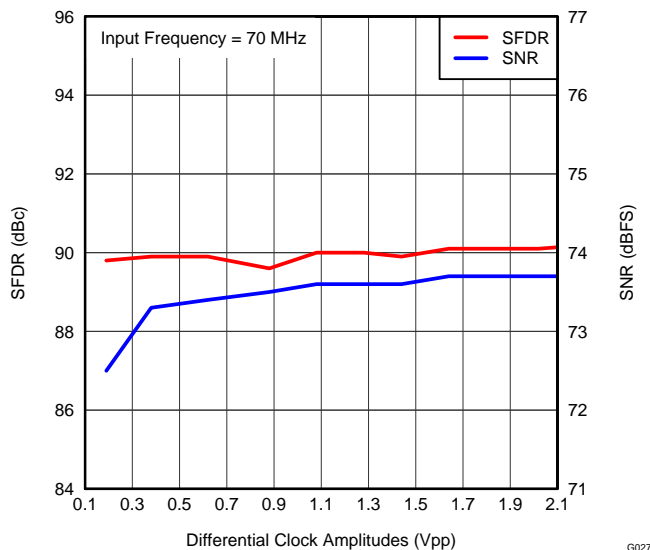

**Figure 37. PERFORMANCE vs CLOCK AMPLITUDE (70 MHz)**

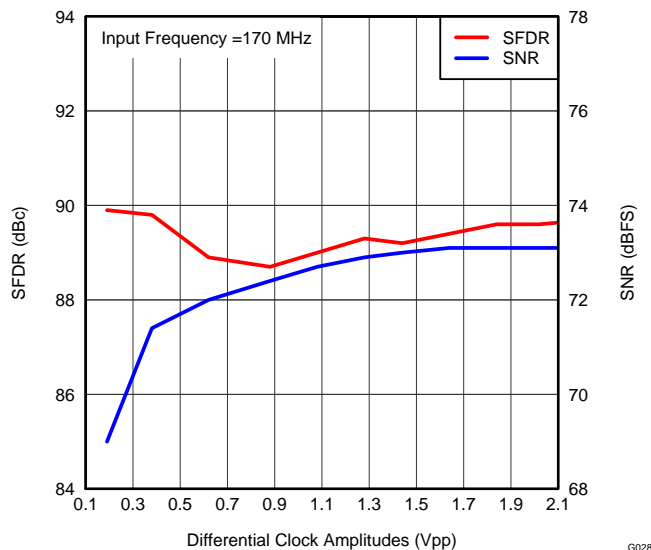

**Figure 38. PERFORMANCE vs CLOCK AMPLITUDE (170 MHz)**

**TYPICAL CHARACTERISTICS: ADS42LB69 (continued)**

Typical values are at  $T_A = +25^\circ\text{C}$ , full temperature range is  $T_{\text{MIN}} = -40^\circ\text{C}$  to  $T_{\text{MAX}} = +85^\circ\text{C}$ , ADC sampling rate = 250 MSPS, 50% clock duty cycle, QDR interface, AVDD3V = 3.3 V, AVDD = DRVDD = 1.8 V, -1-dBFS differential input, and 32k-point FFT, unless otherwise noted.

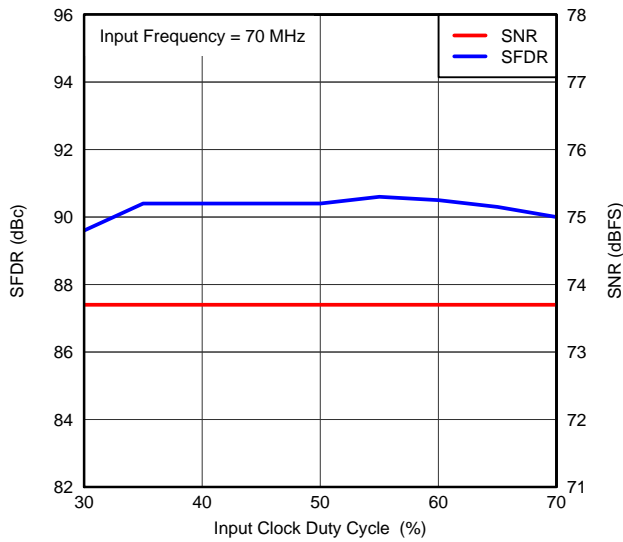

**Figure 39. PERFORMANCE vs CLOCK DUTY CYCLE (70 MHz)**

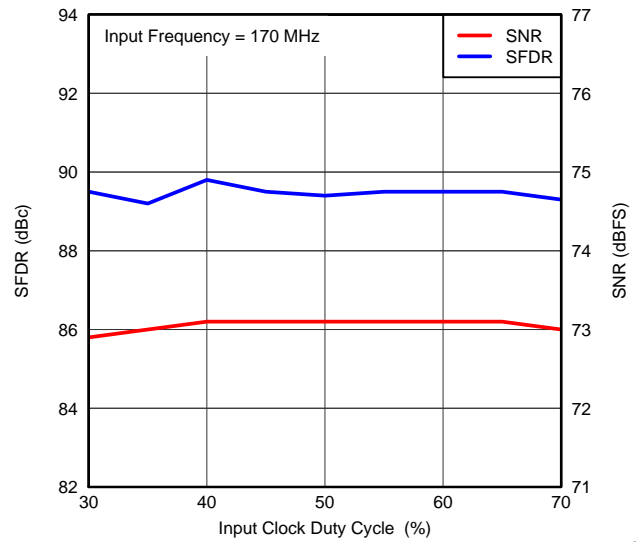

**Figure 40. PERFORMANCE vs CLOCK DUTY CYCLE (170 MHz)**

### TYPICAL CHARACTERISTICS: ADS42LB49

Typical values are at  $T_A = +25^\circ\text{C}$ , full temperature range is  $T_{\text{MIN}} = -40^\circ\text{C}$  to  $T_{\text{MAX}} = +85^\circ\text{C}$ , ADC sampling rate = 250 MSPS, 50% clock duty cycle,  $\text{AVDD3V} = 3.3\text{ V}$ ,  $\text{AVDD} = \text{DRVDD} = 1.8\text{ V}$ ,  $-1\text{-dBFS}$  differential input, and 32k-point FFT, unless otherwise noted.

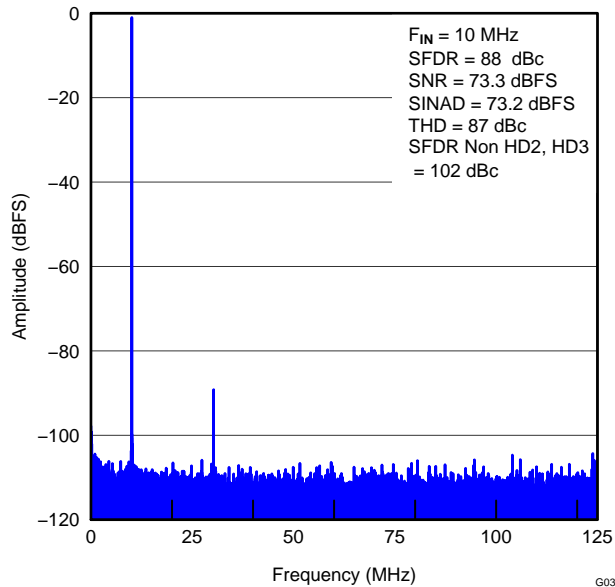

Figure 41. FFT FOR 10-MHz INPUT SIGNAL

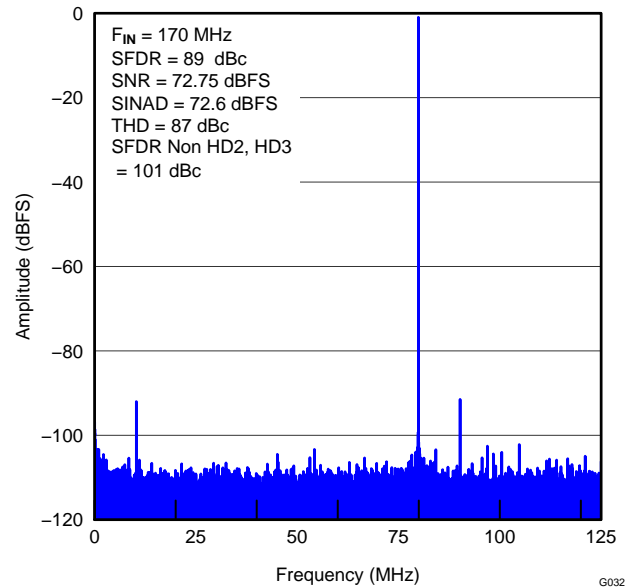

Figure 42. FFT FOR 170-MHz INPUT SIGNAL

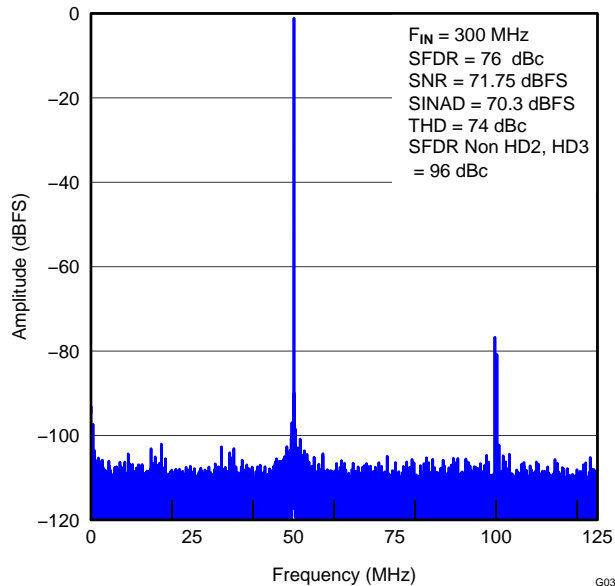

Figure 43. FFT FOR 300-MHz INPUT SIGNAL

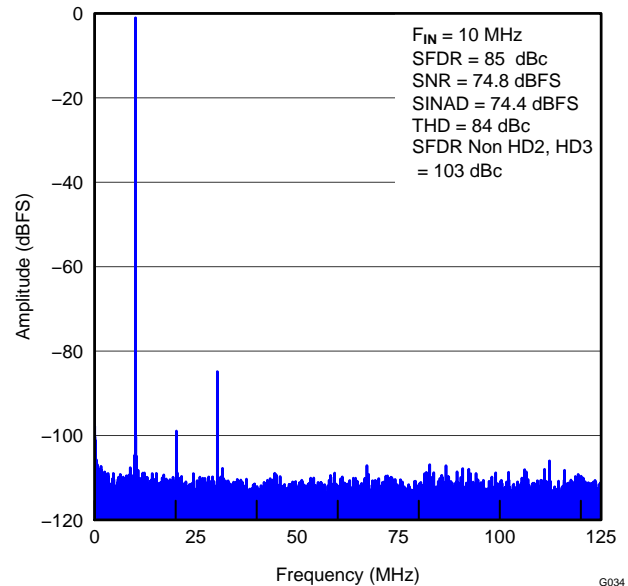
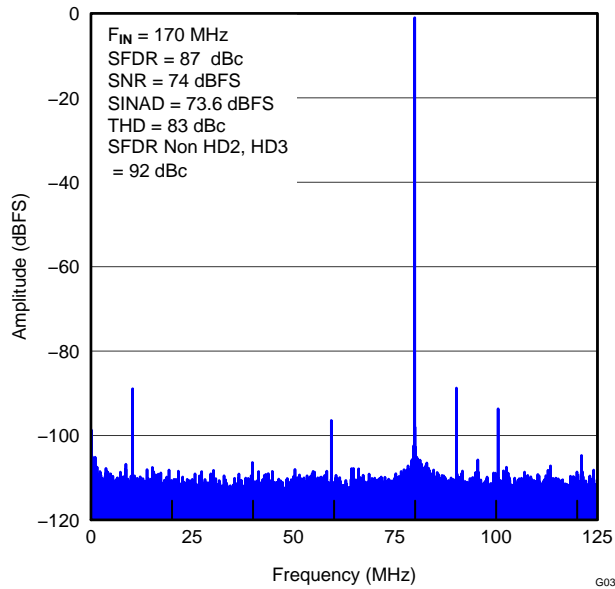

Figure 44. FFT FOR 10-MHz INPUT SIGNAL (2.5-V<sub>pp</sub> Full-Scale)

**TYPICAL CHARACTERISTICS: ADS42LB49 (continued)**

Typical values are at  $T_A = +25^\circ\text{C}$ , full temperature range is  $T_{\text{MIN}} = -40^\circ\text{C}$  to  $T_{\text{MAX}} = +85^\circ\text{C}$ , ADC sampling rate = 250 MSPS, 50% clock duty cycle,  $AV_{\text{DD}3\text{V}} = 3.3\text{ V}$ ,  $AV_{\text{DD}} = DRV_{\text{DD}} = 1.8\text{ V}$ , -1-dBFS differential input, and 32k-point FFT, unless otherwise noted.



**Figure 45. FFT FOR 170-MHz INPUT SIGNAL (2.5-V<sub>pp</sub> Full-Scale)**

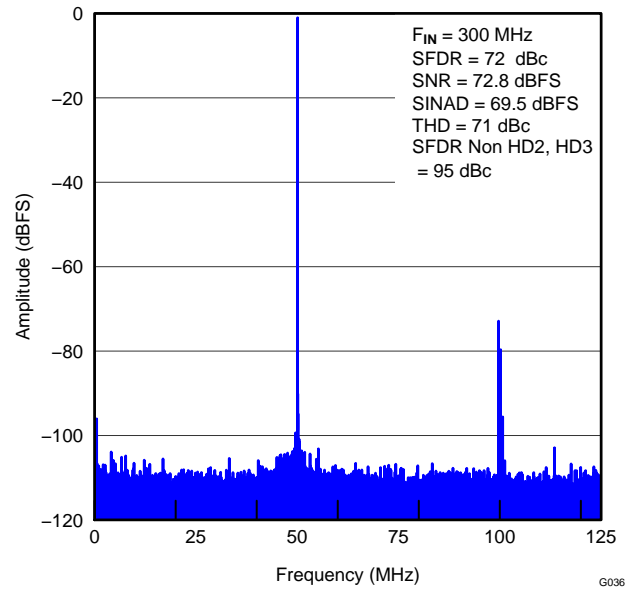

**Figure 46. FFT FOR 300-MHz INPUT SIGNAL (2.5-V<sub>pp</sub> Full-Scale)**

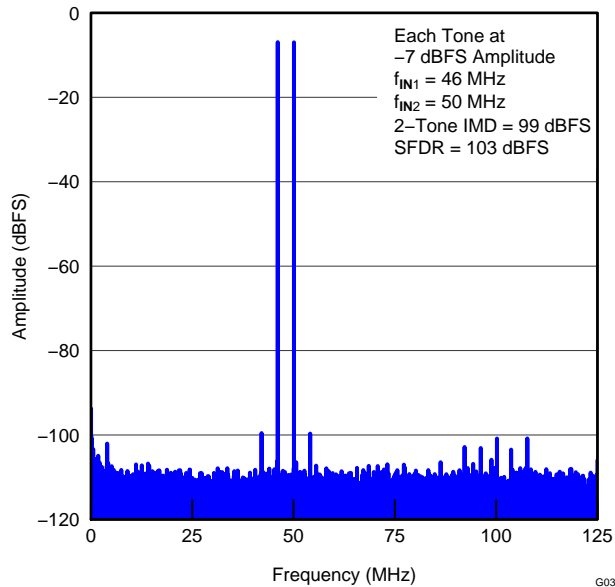

**Figure 47. FFT FOR TWO-TONE INPUT SIGNAL (At -7 dBFS, 46 MHz and 50 MHz)**

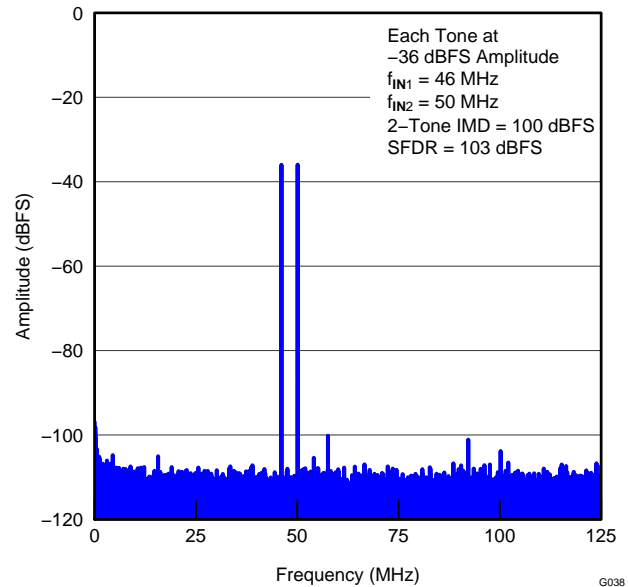

**Figure 48. FFT FOR TWO-TONE INPUT SIGNAL (At -36 dBFS, 46 MHz and 50 MHz)**

**TYPICAL CHARACTERISTICS: ADS42LB49 (continued)**

Typical values are at  $T_A = +25^\circ\text{C}$ , full temperature range is  $T_{\text{MIN}} = -40^\circ\text{C}$  to  $T_{\text{MAX}} = +85^\circ\text{C}$ , ADC sampling rate = 250 MSPS, 50% clock duty cycle,  $\text{AVDD3V} = 3.3\text{ V}$ ,  $\text{AVDD} = \text{DRVDD} = 1.8\text{ V}$ , -1-dBFS differential input, and 32k-point FFT, unless otherwise noted.

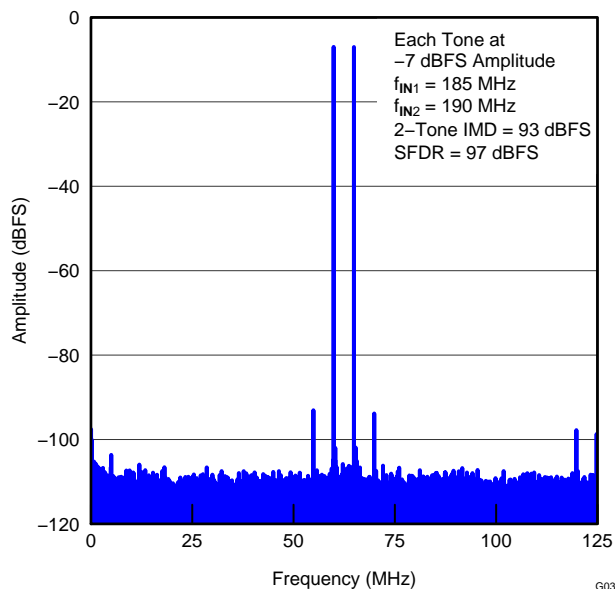

**Figure 49. FFT FOR TWO-TONE INPUT SIGNAL (At -7 dBFS, 185 MHz and 190 MHz)**

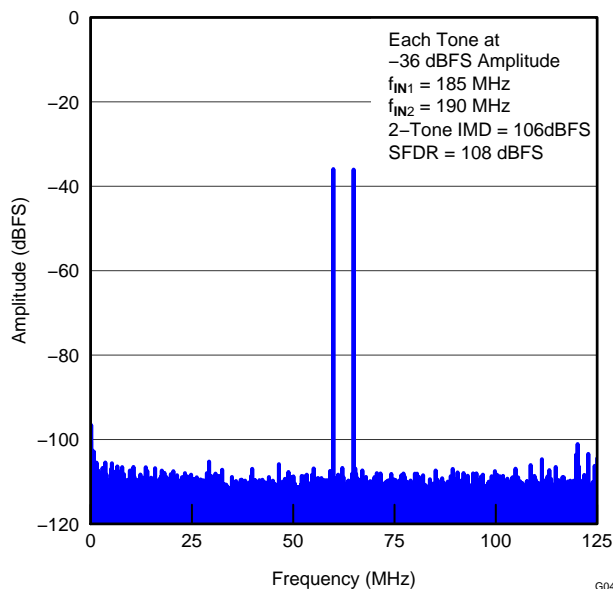

**Figure 50. FFT FOR TWO-TONE INPUT SIGNAL (At -36 dBFS, 185 MHz and 190 MHz)**

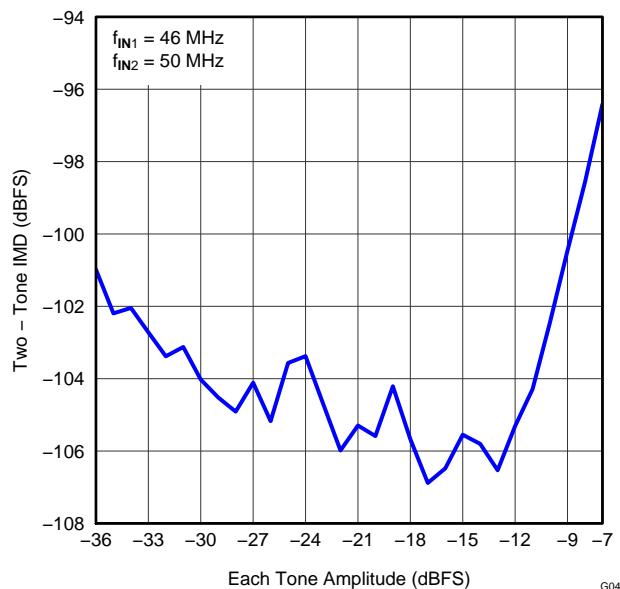

**Figure 51. IMD3 vs INPUT AMPLITUDE (46 MHz and 50 MHz)**

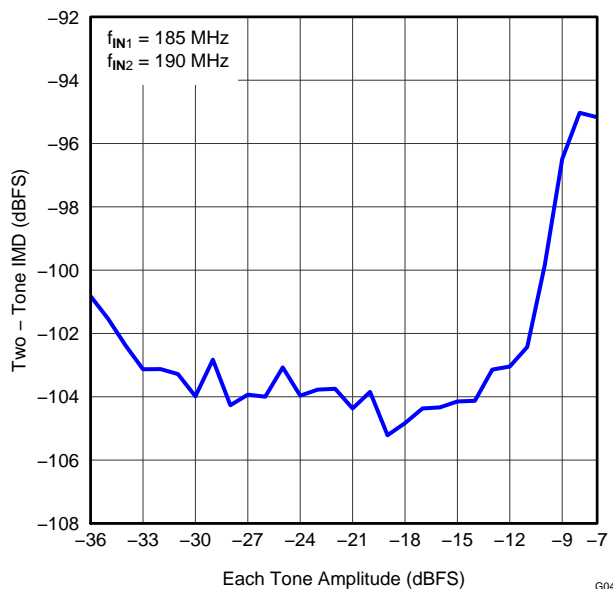

**Figure 52. IMD3 vs INPUT AMPLITUDE (185 MHz and 190 MHz)**

**TYPICAL CHARACTERISTICS: ADS42LB49 (continued)**

Typical values are at  $T_A = +25^\circ\text{C}$ , full temperature range is  $T_{\text{MIN}} = -40^\circ\text{C}$  to  $T_{\text{MAX}} = +85^\circ\text{C}$ , ADC sampling rate = 250 MSPS, 50% clock duty cycle,  $AVDD3V = 3.3\text{ V}$ ,  $AVDD = DRVDD = 1.8\text{ V}$ ,  $-1\text{-dBFS}$  differential input, and 32k-point FFT, unless otherwise noted.

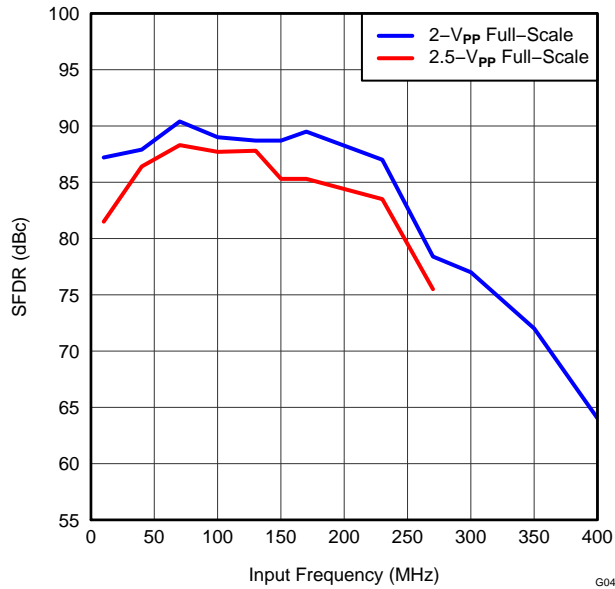

Figure 53. SFDR vs INPUT FREQUENCY

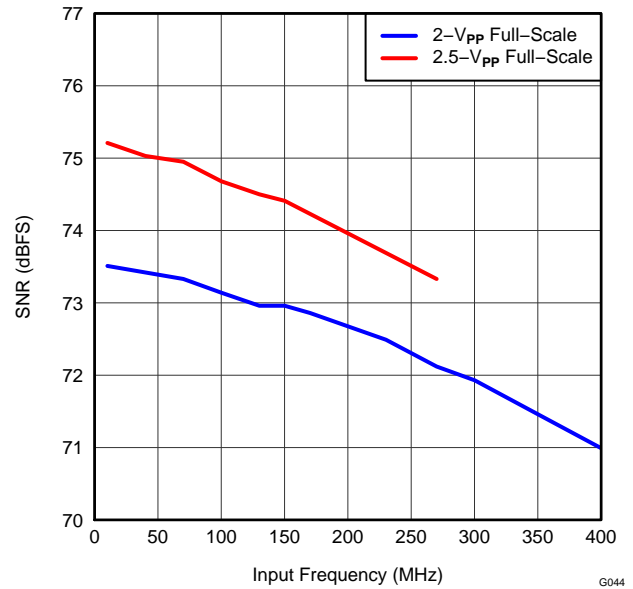

Figure 54. SNR vs INPUT FREQUENCY

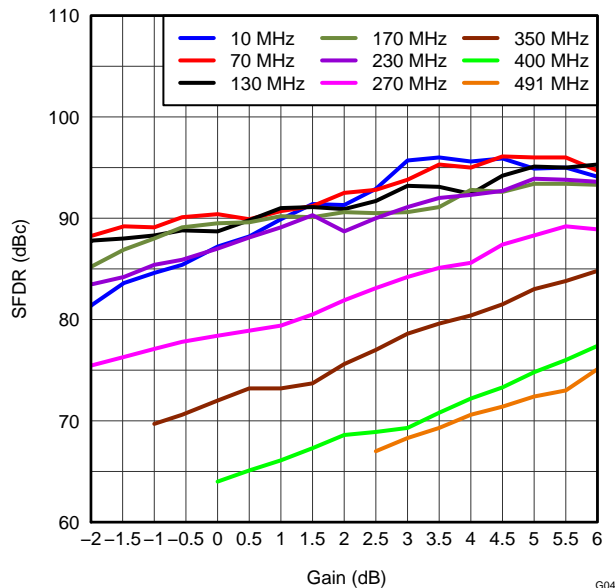

Figure 55. SFDR vs DIGITAL GAIN

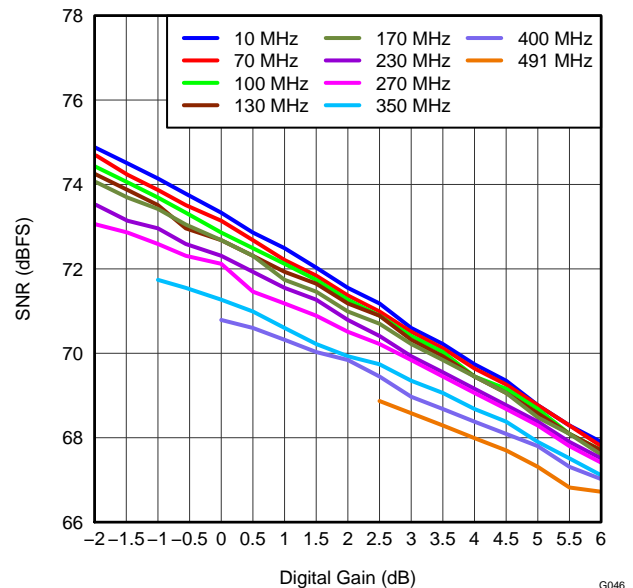

Figure 56. SNR vs DIGITAL GAIN

### TYPICAL CHARACTERISTICS: ADS42LB49 (continued)

Typical values are at  $T_A = +25^\circ\text{C}$ , full temperature range is  $T_{\text{MIN}} = -40^\circ\text{C}$  to  $T_{\text{MAX}} = +85^\circ\text{C}$ , ADC sampling rate = 250 MSPS, 50% clock duty cycle,  $\text{AVDD3V} = 3.3\text{ V}$ ,  $\text{AVDD} = \text{DRVDD} = 1.8\text{ V}$ ,  $-1\text{-dBFS}$  differential input, and 32k-point FFT, unless otherwise noted.

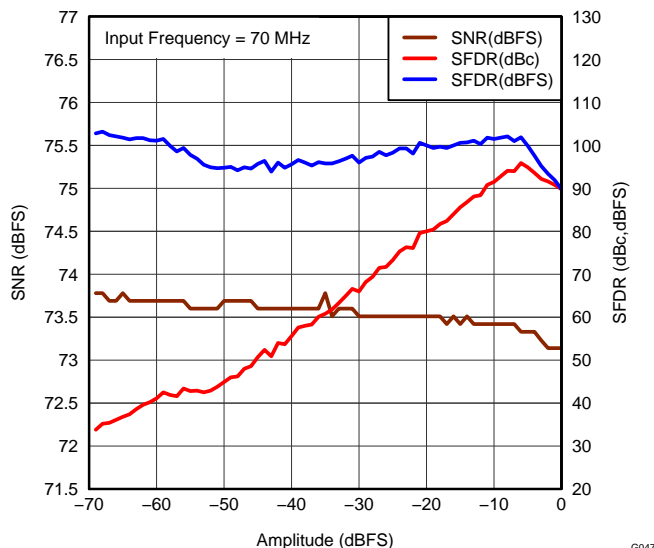

Figure 57. PERFORMANCE ACROSS INPUT AMPLITUDE (70 MHz)

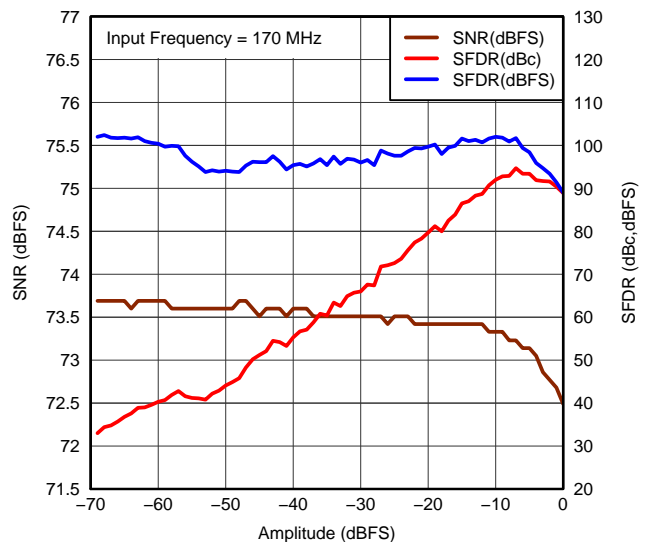

Figure 58. PERFORMANCE ACROSS INPUT AMPLITUDE (170 MHz)

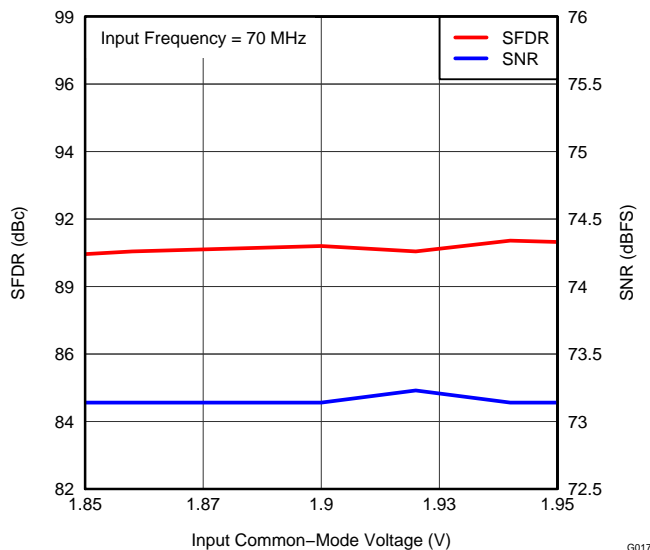

Figure 59. PERFORMANCE vs INPUT COMMON-MODE VOLTAGE (70 MHz)

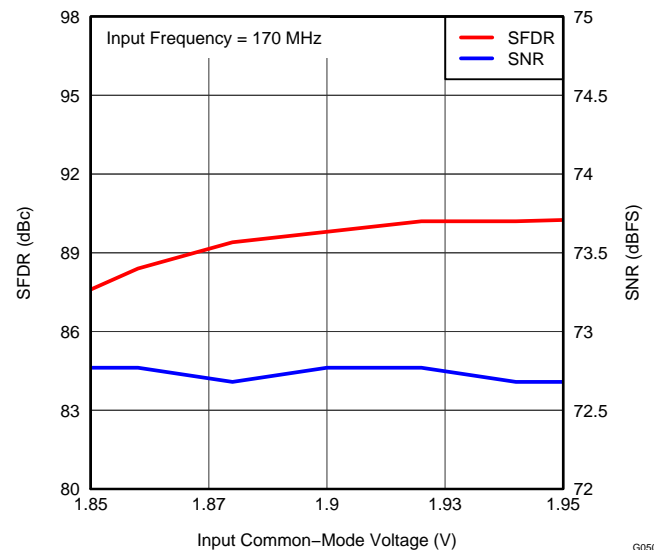

Figure 60. PERFORMANCE vs INPUT COMMON-MODE VOLTAGE (170 MHz)

**TYPICAL CHARACTERISTICS: ADS42LB49 (continued)**

Typical values are at  $T_A = +25^\circ\text{C}$ , full temperature range is  $T_{\text{MIN}} = -40^\circ\text{C}$  to  $T_{\text{MAX}} = +85^\circ\text{C}$ , ADC sampling rate = 250 MSPS, 50% clock duty cycle, AVDD3V = 3.3 V, AVDD = DRVDD = 1.8 V, -1-dBFS differential input, and 32k-point FFT, unless otherwise noted.

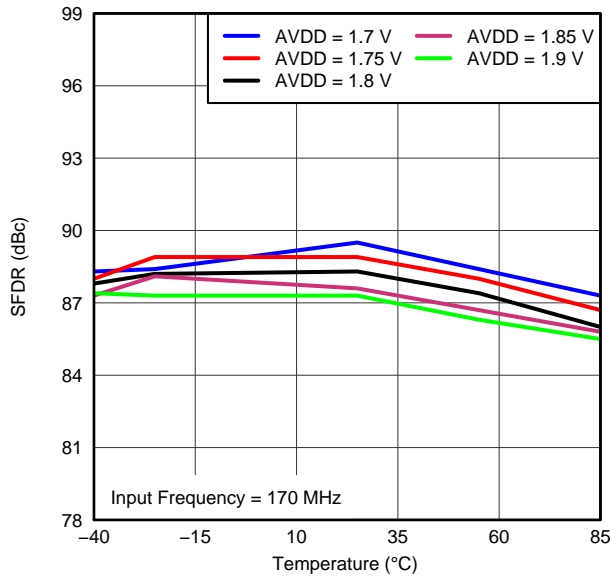

Figure 61. SFDR vs AVDD SUPPLY AND TEMPERATURE (170 MHz) G051

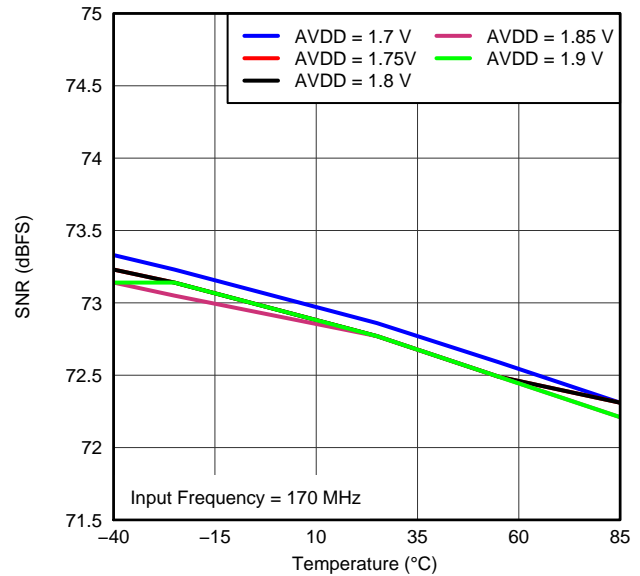

Figure 62. SNR vs AVDD SUPPLY AND TEMPERATURE (170 MHz) G052

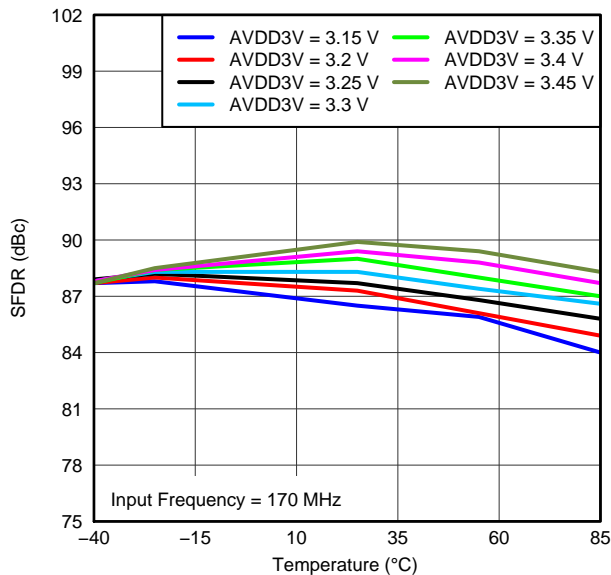

Figure 63. SFDR vs AVDD\_BUF SUPPLY AND TEMPERATURE (170 MHz) G053

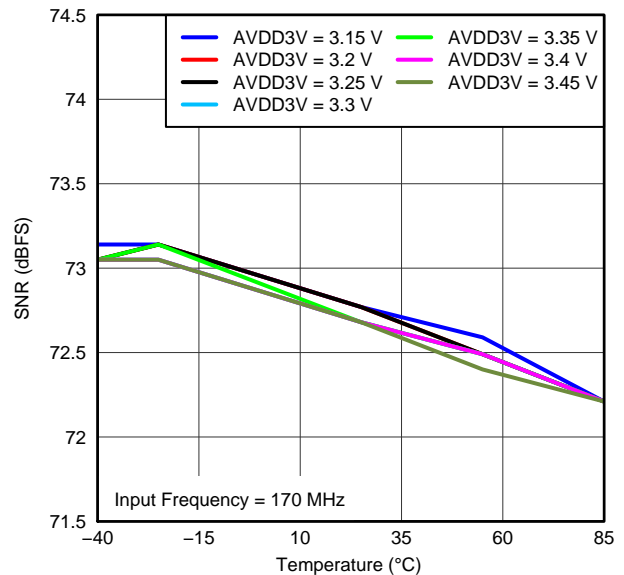
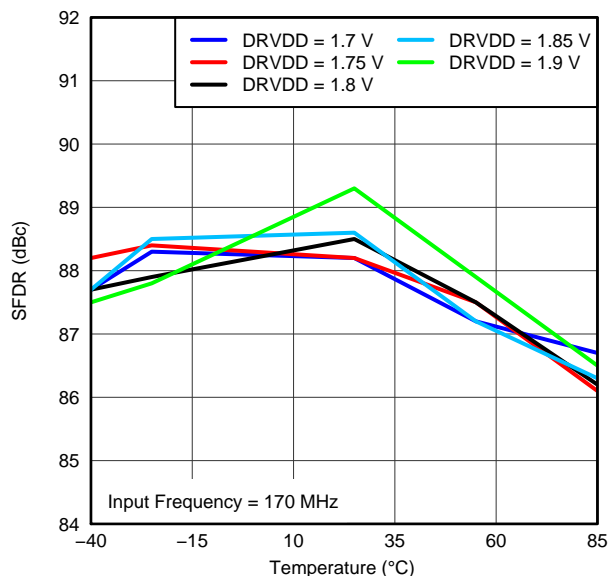

Figure 64. SNR vs AVDD\_BUF SUPPLY AND TEMPERATURE (170 MHz) G054

**TYPICAL CHARACTERISTICS: ADS42LB49 (continued)**

Typical values are at  $T_A = +25^\circ\text{C}$ , full temperature range is  $T_{\text{MIN}} = -40^\circ\text{C}$  to  $T_{\text{MAX}} = +85^\circ\text{C}$ , ADC sampling rate = 250 MSPS, 50% clock duty cycle,  $\text{AVDD3V} = 3.3\text{ V}$ ,  $\text{AVDD} = \text{DRVDD} = 1.8\text{ V}$ ,  $-1\text{-dBFS}$  differential input, and 32k-point FFT, unless otherwise noted.



**Figure 65. SFDR vs DRVDD SUPPLY AND TEMPERATURE (170 MHz)**

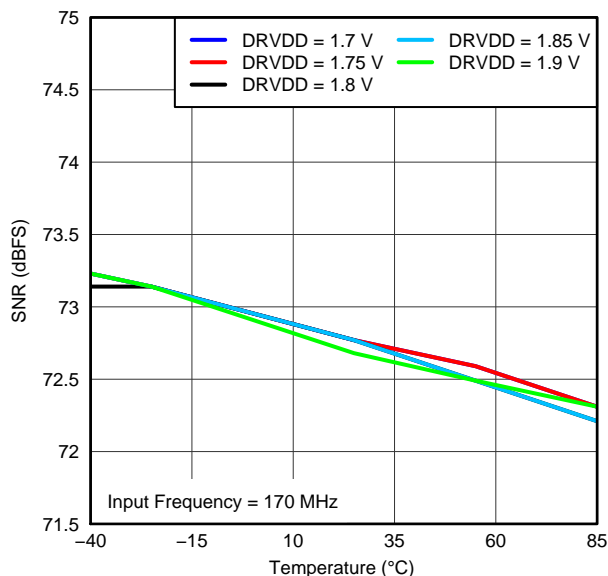

**Figure 66. SNR vs DRVDD SUPPLY AND TEMPERATURE (170 MHz)**

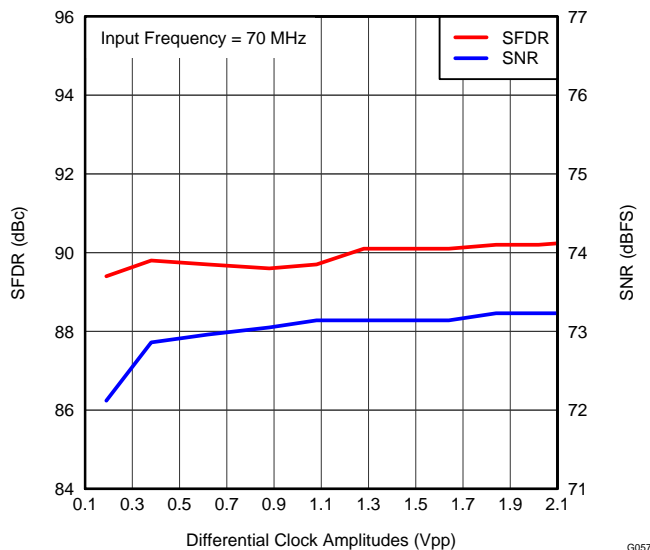

**Figure 67. PERFORMANCE vs CLOCK AMPLITUDE (70 MHz)**

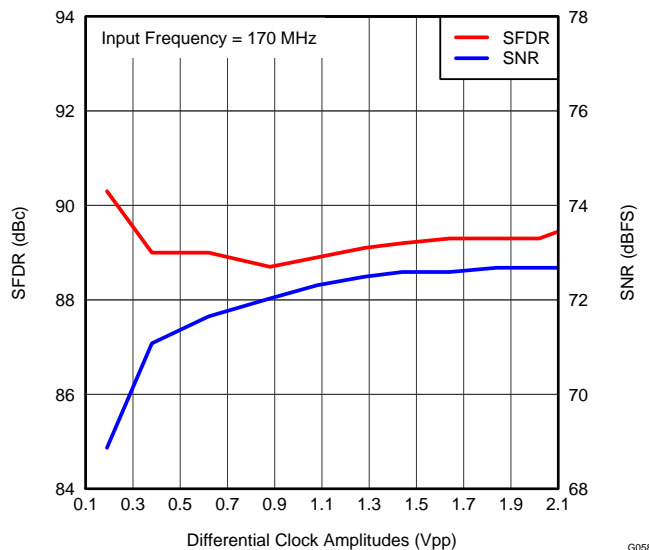

**Figure 68. PERFORMANCE vs CLOCK AMPLITUDE (170 MHz)**

**TYPICAL CHARACTERISTICS: ADS42LB49 (continued)**

Typical values are at  $T_A = +25^\circ\text{C}$ , full temperature range is  $T_{\text{MIN}} = -40^\circ\text{C}$  to  $T_{\text{MAX}} = +85^\circ\text{C}$ , ADC sampling rate = 250 MSPS, 50% clock duty cycle,  $\text{AVDD3V} = 3.3\text{ V}$ ,  $\text{AVDD} = \text{DRVDD} = 1.8\text{ V}$ ,  $-1\text{-dBFS}$  differential input, and 32k-point FFT, unless otherwise noted.

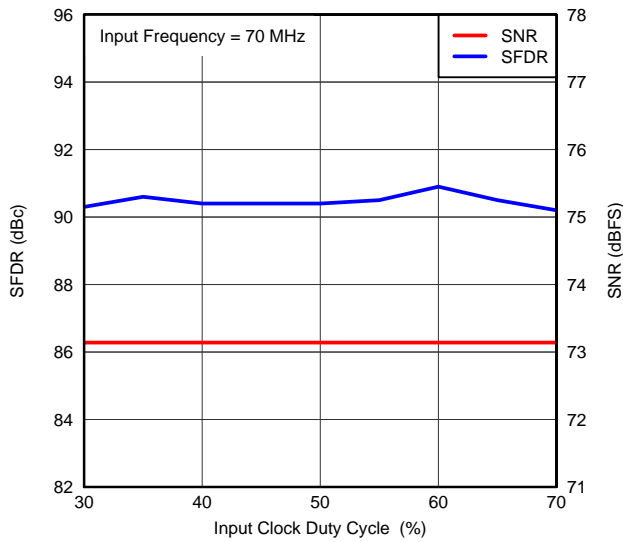

**Figure 69. PERFORMANCE vs CLOCK DUTY CYCLE (70 MHz)**

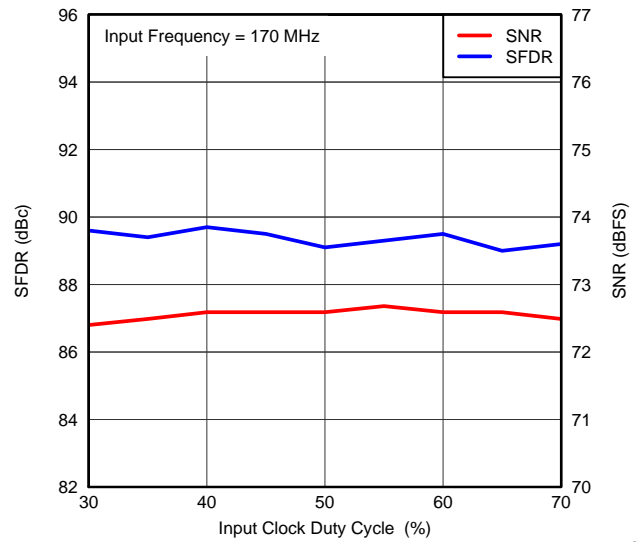

**Figure 70. PERFORMANCE vs CLOCK DUTY CYCLE (170 MHz)**

### TYPICAL CHARACTERISTICS: Common

Typical values are at  $T_A = +25^\circ\text{C}$ , full temperature range is  $T_{\text{MIN}} = -40^\circ\text{C}$  to  $T_{\text{MAX}} = +85^\circ\text{C}$ , ADC sampling rate = 250 MSPS, 50% clock duty cycle,  $\text{AVDD3V} = 3.3\text{ V}$ ,  $\text{AVDD} = \text{DRVDD} = 1.8\text{ V}$ ,  $-1\text{-dBFS}$  differential input, and 32k-point FFT, unless otherwise noted.

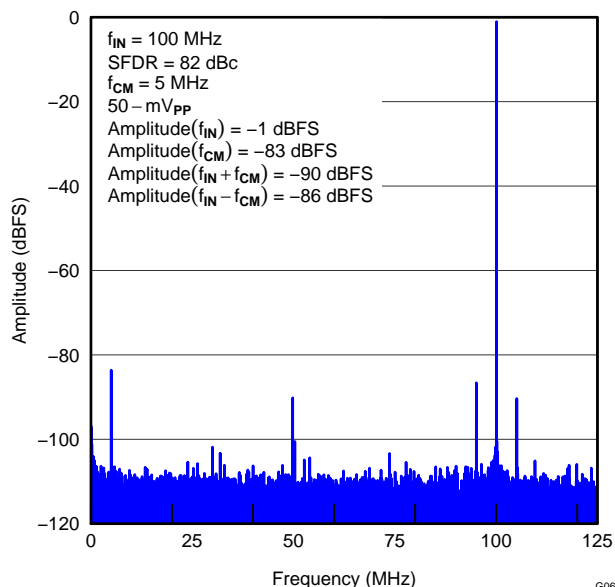

Figure 71. CMRR FFT

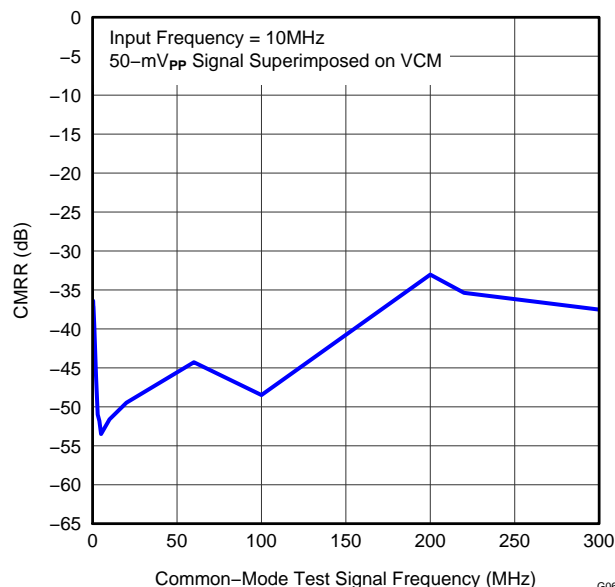

Figure 72. CMRR vs TEST SIGNAL FREQUENCY

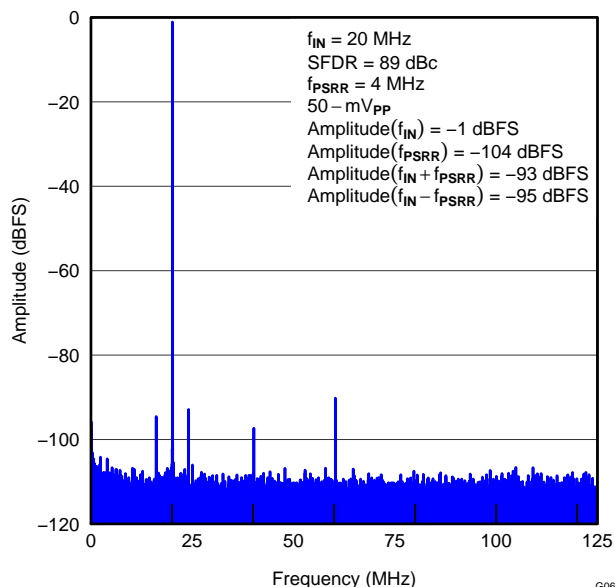

Figure 73. PSRR FFT FOR AVDD SUPPLY

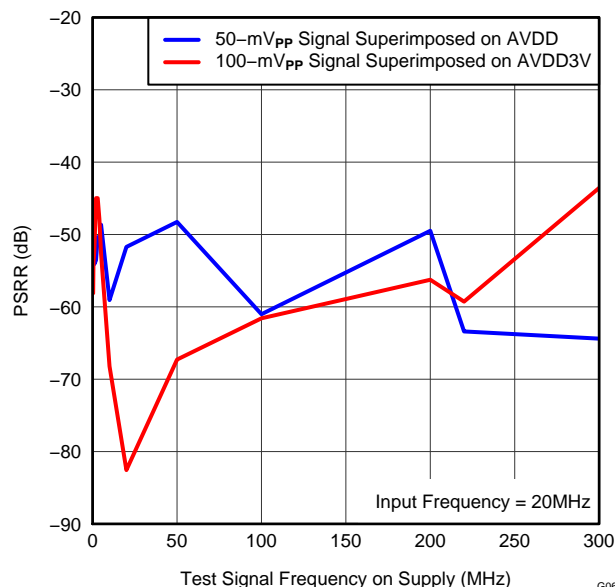

Figure 74. PSRR vs TEST SIGNAL FREQUENCY

**TYPICAL CHARACTERISTICS: Common (continued)**

Typical values are at  $T_A = +25^\circ\text{C}$ , full temperature range is  $T_{\text{MIN}} = -40^\circ\text{C}$  to  $T_{\text{MAX}} = +85^\circ\text{C}$ , ADC sampling rate = 250 MSPS, 50% clock duty cycle, AVDD3V = 3.3 V, AVDD = DRVDD = 1.8 V, -1-dBFS differential input, and 32k-point FFT, unless otherwise noted.

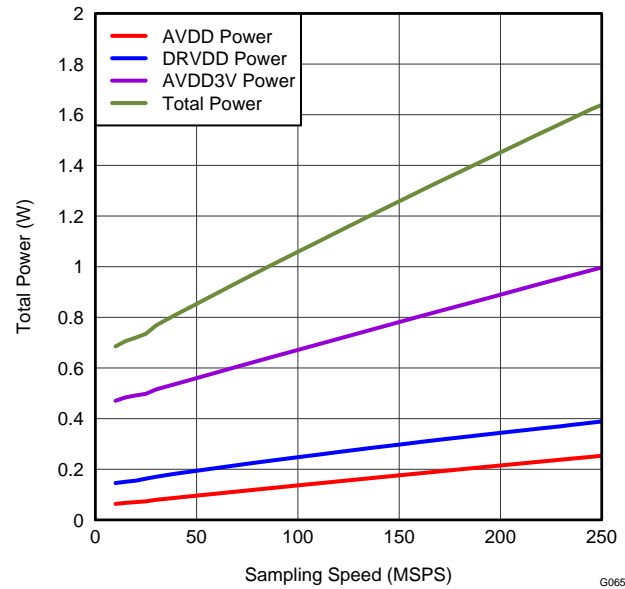

Figure 75. TOTAL POWER vs SAMPLING FREQUENCY <sup>G065</sup>

### TYPICAL CHARACTERISTICS: Contour

Typical values are at  $T_A = +25^\circ\text{C}$ , full temperature range is  $T_{\text{MIN}} = -40^\circ\text{C}$  to  $T_{\text{MAX}} = +85^\circ\text{C}$ , ADC sampling rate = 250 MSPS, 50% clock duty cycle,  $\text{AVDD3V} = 3.3\text{ V}$ ,  $\text{AVDD} = \text{DRVDD} = 1.8\text{ V}$ ,  $-1\text{-dBFS}$  differential input, and 65k-point FFT, unless otherwise noted.

### Spurious-Free Dynamic Range (SFDR): General

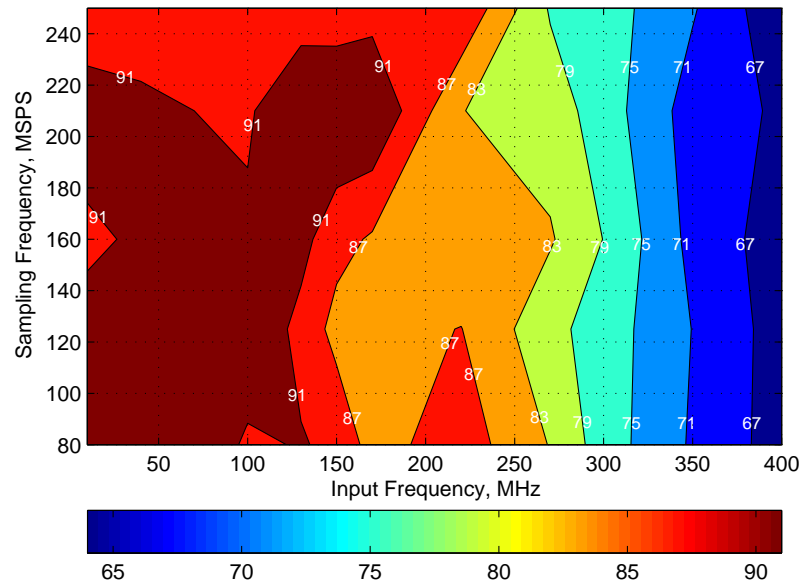

Figure 76. SFDR (0-dB Gain)

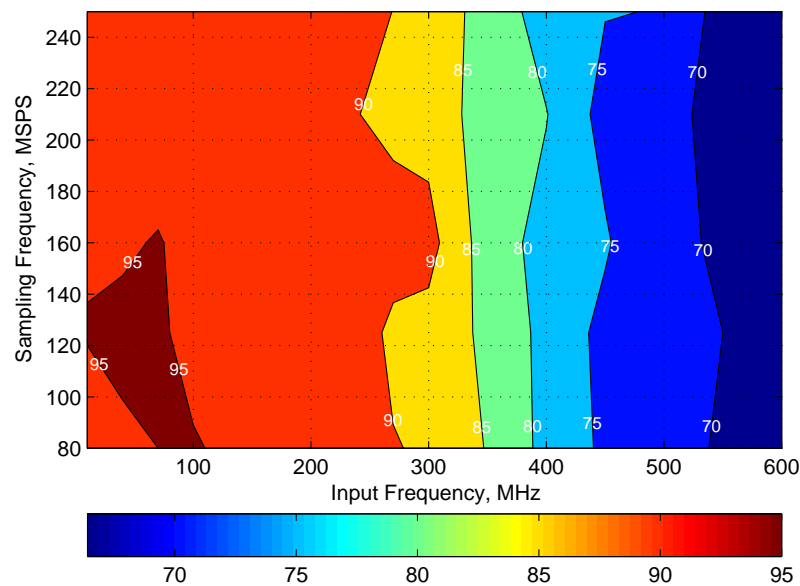

Figure 77. SFDR (6-dB Gain)

**TYPICAL CHARACTERISTICS: Contour (continued)**

Typical values are at  $T_A = +25^\circ\text{C}$ , full temperature range is  $T_{\text{MIN}} = -40^\circ\text{C}$  to  $T_{\text{MAX}} = +85^\circ\text{C}$ , ADC sampling rate = 250 MSPS, 50% clock duty cycle,  $\text{AVDD3V} = 3.3\text{ V}$ ,  $\text{AVDD} = \text{DRVDD} = 1.8\text{ V}$ ,  $-1\text{-dBFS}$  differential input, and 65k-point FFT, unless otherwise noted.

**Signal-to-Noise Ratio (SNR): ADS42LB69**

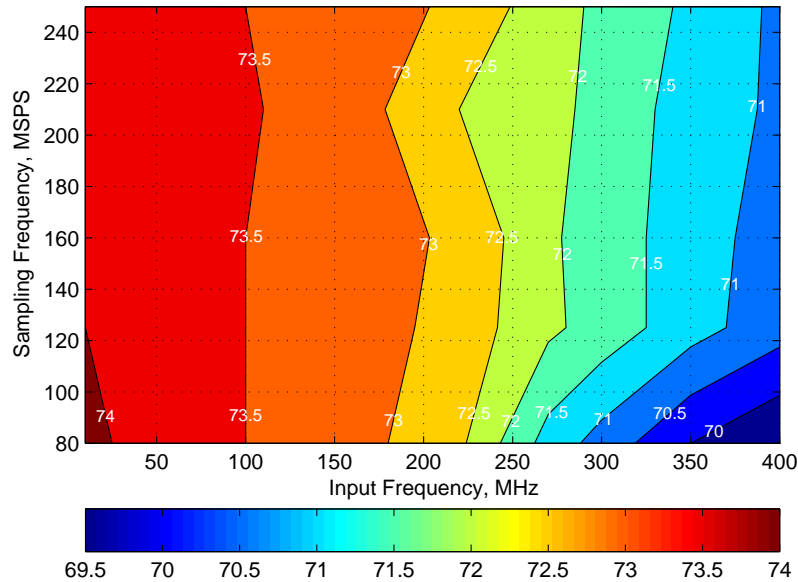

Figure 78. SNR (0-dB Gain, 16 Bits)

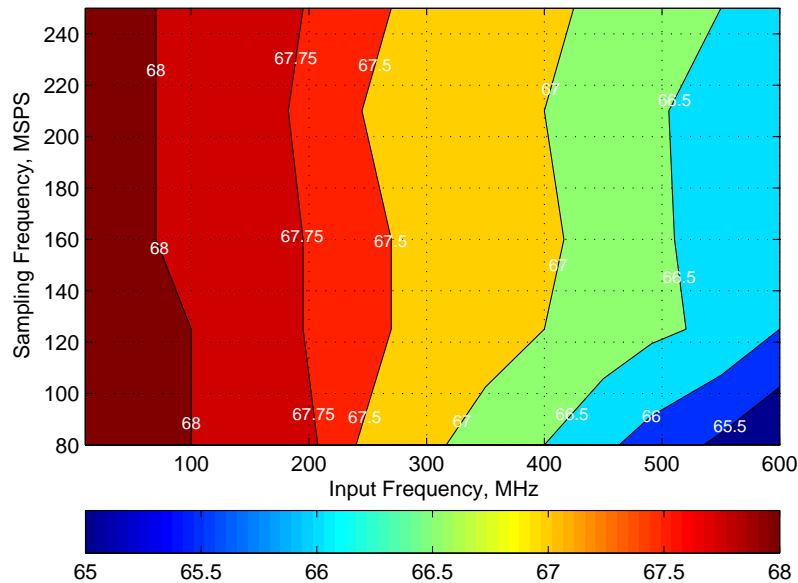

Figure 79. SNR (6-dB Gain, 16 Bits)

**TYPICAL CHARACTERISTICS: Contour (continued)**

Typical values are at  $T_A = +25^\circ\text{C}$ , full temperature range is  $T_{\text{MIN}} = -40^\circ\text{C}$  to  $T_{\text{MAX}} = +85^\circ\text{C}$ , ADC sampling rate = 250 MSPS, 50% clock duty cycle, AVDD3V = 3.3 V, AVDD = DRVDD = 1.8 V, -1-dBFS differential input, and 65k-point FFT, unless otherwise noted.

**Signal-to-Noise Ratio (SNR): ADS42LB49**

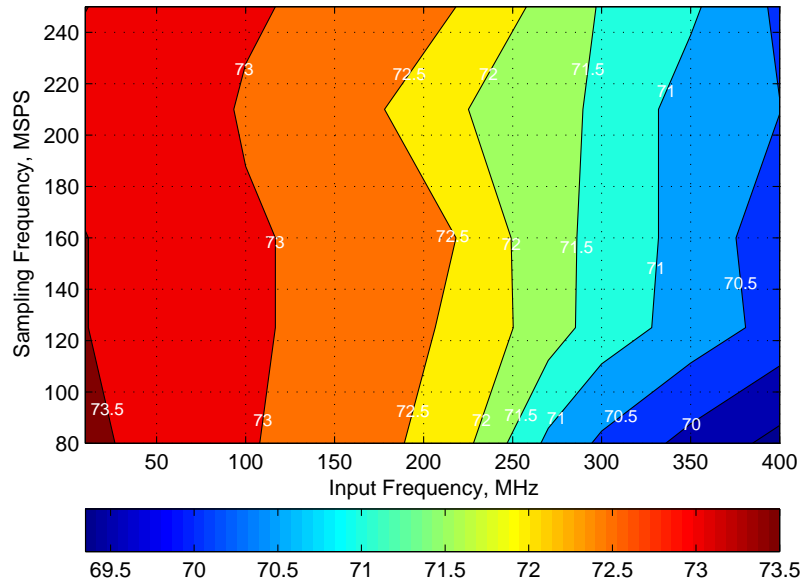

Figure 80. SNR (0-dB Gain, 14 Bits)

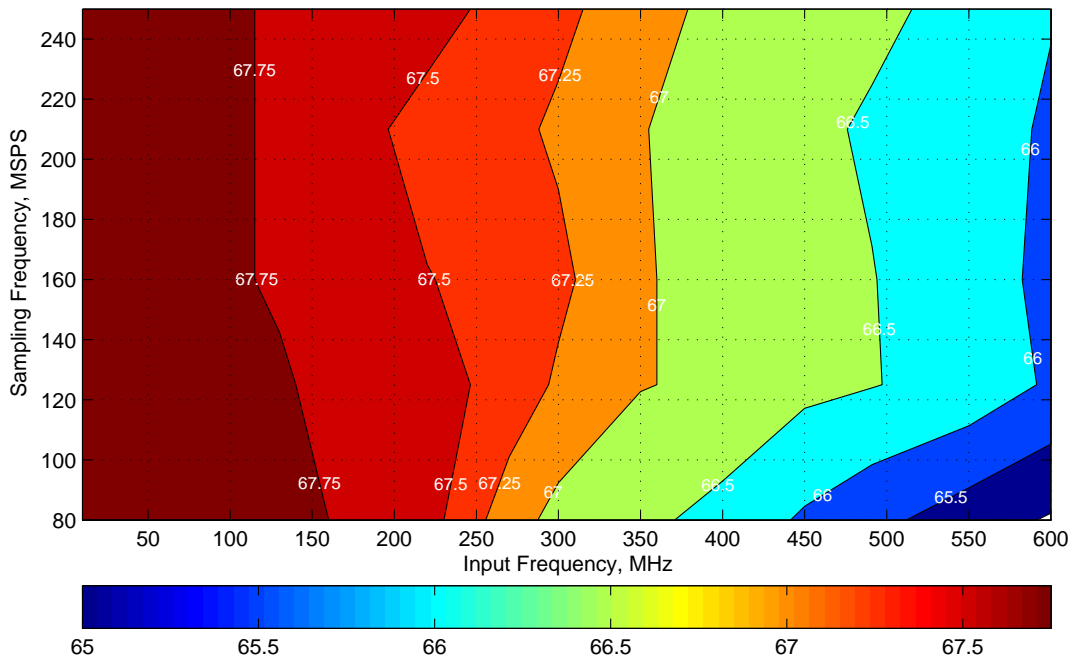

Figure 81. SNR (6-dB Gain, 14 Bits)

## DEVICE CONFIGURATION

The ADS42LB49 and ADS42LB69 can be configured using a serial programming interface, as described in this section. In addition, the device has two bidirectional parallel pins (CTRL1 and CTRL2). By default, these pins act as input pins and control the power-down modes, as described in [Table 5](#) and [Table 6](#). These pins can be programmed as output pins that deliver overrange information by setting the PDN/OVR\_FOR\_CTRL\_PINS register bit.

**Table 5. PDN/OVR\_FOR\_CTRL\_PINS Bit (Set to '0')**

CTRL2	CTRL1	PIN DIRECTION	FUNCTION
Low	Low	Input	Default operation
Low	High	Input	Channel A power-down
High	Low	Input	Channel B powers down in QDR mode. Do not use in DDR mode.
High	High	Input	Channels A and B power-down

**Table 6. PDN/OVR\_FOR\_CTRL\_PINS Bit (Set to '1')**

CTRL2	CTRL1	PIN DIRECTION
Carries OVR for channel B	Carries OVR for channel A	Output

## DETAILS OF SERIAL INTERFACE

The ADC has a set of internal registers that can be accessed by the serial interface formed by the SEN (serial interface enable), SCLK (serial interface clock), SDATA (serial interface data) and SDOOUT (serial interface data output) pins. Serial shift of bits into the device is enabled when SEN is low. Serial data SDATA are latched at every SCLK rising edge when SEN is active (low). The serial data are loaded into the register at every 16th SCLK rising edge when SEN is low. When the word length exceeds a multiple of 16 bits, the excess bits are ignored. Data can be loaded in multiples of 16-bit words within a single active SEN pulse. The interface can work with SCLK frequencies from 20 MHz down to very low speeds (of a few hertz) and also with non-50% SCLK duty cycle.

## Register Initialization

After power-up, the internal registers must be initialized to their default values through a *hardware reset* by applying a high pulse on the RESET pin (of widths greater than 10 ns), as shown in Figure 82 and Table 7. If required, serial interface registers can later be cleared during operation by:

1. Either through a hardware reset or
2. By applying a software reset. When using the serial interface, set the RESET bit (D0 in register address 08h) high. This setting initializes the internal registers to the default values and then self-resets the RESET bit low. In this case, the RESET pin is kept low.

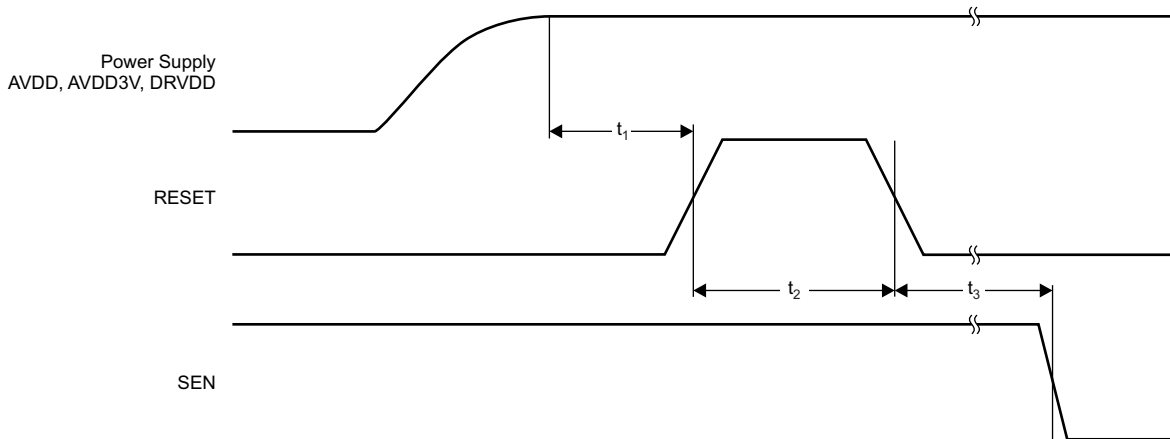

NOTE: After power-up, the internal registers must be initialized to their default values through a hardware reset by applying a high pulse on the RESET pin.

Figure 82. Reset Timing Diagram

Table 7. Reset Timing <sup>(1)</sup>

PARAMETER	CONDITIONS	MIN	TYP	MAX	UNIT	
$t_1$	Power-on delay	Delay from AVDD and DRVDD power-up to active RESET pulse			1	ms
$t_2$	Reset pulse width	Active RESET signal pulse width			10	ns
						1
$t_3$	Register write delay	Delay from RESET disable to SEN active			100	ns

(1) Typical values at +25°C; minimum and maximum values across the full temperature range:  $T_{MIN} = -40^\circ\text{C}$  to  $T_{MAX} = +85^\circ\text{C}$ , unless otherwise noted.

### Serial Register Write

The internal register of the ADS42LB49 and ADS42LB69 can be programmed following these steps:

1. Drive SEN pin low
2. Set the R/W bit to '0' (bit A7 of the 8 bit address)
3. Set bit A6 in the address field to '0'
4. Initiate a serial interface cycle specifying the address of the register (A5 to A0) whose content must be written
5. Write 8 bit data which is latched in on the rising edge of SCLK.

Figure 83 and Table 8 illustrate these steps.

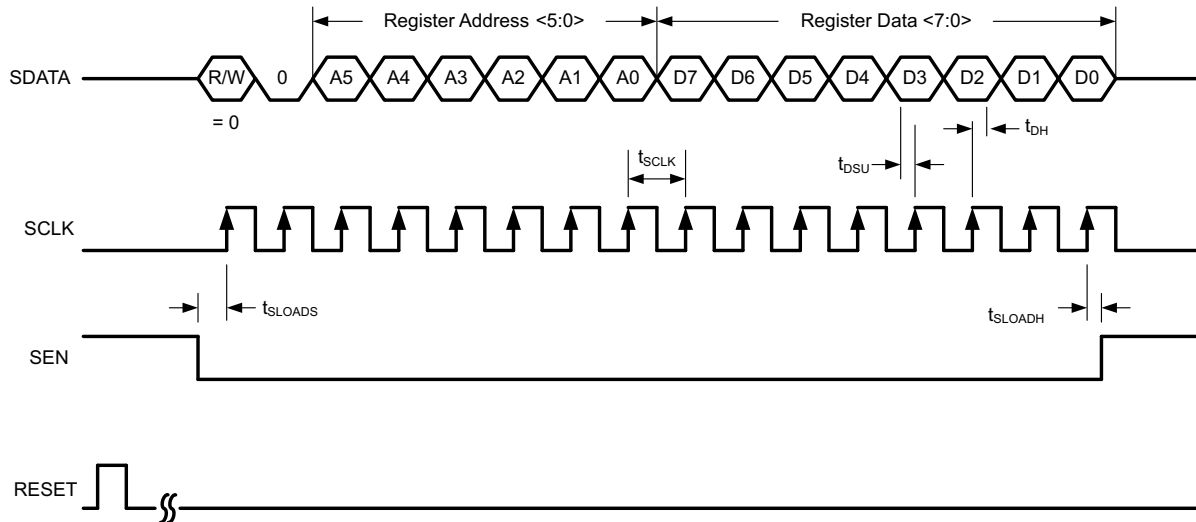

Figure 83. Serial Register Write Timing Diagram

Table 8. Serial Interface Timing (only when Serial Interface is Used)<sup>(1)</sup>

PARAMETER	MIN	TYP	MAX	UNIT
$f_{SCLK}$ SCLK frequency (equal to $1 / t_{SCLK}$ )	> dc		20	MHz
$t_{SLOADS}$ SEN to SCLK setup time	25			ns
$t_{SLOADH}$ SCLK to SEN hold time	25			ns
$t_{DSU}$ SDIO setup time	25			ns
$t_{DH}$ SDIO hold time	25			ns

(1) Typical values are at +25°C; minimum and maximum values across the full temperature range:  $T_{MIN} = -40^{\circ}C$  to  $T_{MAX} = +85^{\circ}C$ ,  $AVDD3V = 3.3 V$ , and  $AVDD = DRVDD = 1.8 V$ , unless otherwise noted.

### Serial Register Readout

The device includes a mode where the contents of the internal registers can be read back using the SDOOUT pin. This read-back mode may be useful as a diagnostic check to verify the serial interface communication between the external controller and the ADC.

1. Drive SEN pin low
2. Set the R/W bit (A7) to '1'. This setting disables any further writes to the registers
3. Set bit A6 in the address field to 0.
4. Initiate a serial interface cycle specifying the address of the register (A5 to A0) whose content has to be read.
5. The device outputs the contents (D7 to D0) of the selected register on the SDOOUT pin.
6. The external controller can latch the contents at the SCLK falling edge.
7. To enable register writes, reset the R/W register bit to '0'.

Figure 84 illustrates these steps. When READOUT is disabled, the SDOOUT pin is in a high-impedance mode. If serial readout is not used, the SDOOUT pin must float.

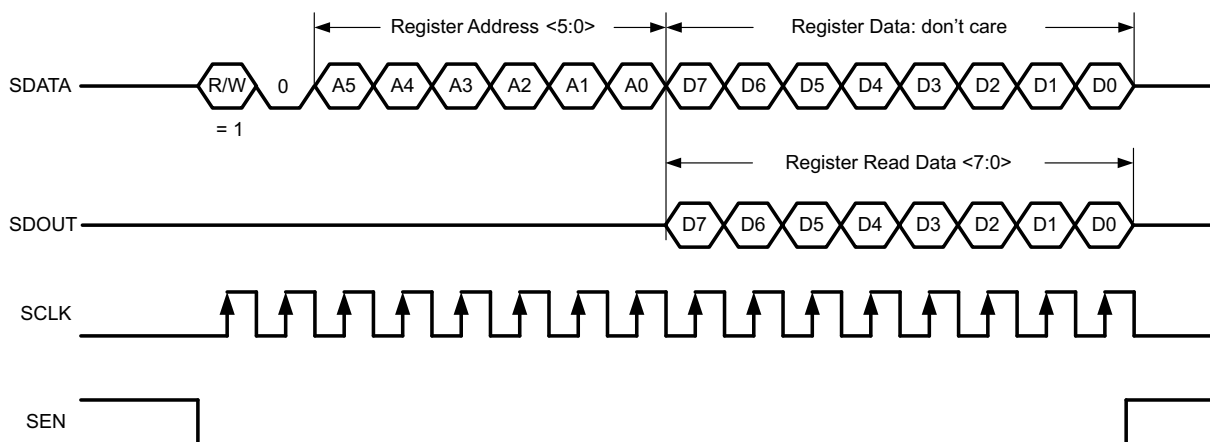

Figure 84. Serial Register Readout Timing Diagram

## SUMMARY OF SERIAL INTERFACE REGISTERS

REGISTER ADDRESS	REGISTER DATA							
A7-A0 IN HEX	D7	D6	D5	D4	D3	D2	D1	D0
6	1	0	0	0	0	0	CLK DIV	
7	0	0	0	0	0	SYNCIN DELAY		
8	PDN CHA	PDN CHB	STDBY	DATA FORMAT	DIS CTRL PINS	TEST PAT ALIGN	0	RESET
B	CHA GAIN					CHA GAIN EN	0	FLIP DATA
C	CHBGAIN					CHB GAIN EN	OVR ON LSB	
D	0	1	1	0	1	1	0	FAST OVR ON PIN
F	CHA TEST PATTERNS				CHB TEST PATTERNS			
10	CUSTOM PATTERN 1 (15:8)							
11	CUSTOM PATTERN 1 (7:0)							
12	CUSTOM PATTERN 2 (15:8)							
13	CUSTOM PATTERN 2 (7:0)							
14	0	0	0	0	LVDS CLK STRENGTH	LVDS DATA STRENGTH	DISABLE OUTPUT CHA	DISABLE OUTPUT CHB
15	0	0	0	0	0	0	0	DDR - QDR
16	0	0	DDR OUTPUT TIMING					0
17	LVDS CLK STRENGTH EN	0	QDR TIMING CHA					INV CLK OUT CHA
18	0	0	QDR TIMING CHB					INV CLK OUT CHB
1F	Always write '0'	FAST OVR THRESHOLD						
20	0	0	0	0	0	0	0	PDN/OVR FOR CTRL PINS

**DESCRIPTION OF SERIAL INTERFACE REGISTERS**

REGISTER ADDRESS	REGISTER DATA							
A7-A0 IN HEX	D7	D6	D5	D4	D3	D2	D1	D0
6	1	0	0	0	0	0	CLK DIV	

Default: 80h

**D[1:0] CLK DIV** Internal clock divider for input sample clock  
 00 Divide-by-1 (clock divider bypassed)  
 01 Divide-by-2  
 10 Divide-by-1  
 11 Divide-by-4

REGISTER ADDRESS	REGISTER DATA							
A7-A0 IN HEX	D7	D6	D5	D4	D3	D2	D1	D0
7	0	0	0	0	0	SYNCIN DELAY		

Default: 00h

**D[2:0] SYNCIN DELAY** Controls the delay of the SYNCIN input with respect to the input clock.  
 Typical values for the expected delay of different settings are:

000	0-ps delay	100	240-ps delay
001	60-ps delay	101	300-ps delay
010	120-ps delay	110	360-ps delay
011	180-ps delay	111	420-ps delay

REGISTER ADDRESS	REGISTER DATA							
A7-A0 IN HEX	D7	D6	D5	D4	D3	D2	D1	D0
8	PDN CHA	PDN CHB	STDBY	DATA FORMAT	DIS CTRL PINS	TEST PAT ALIGN	0	RESET

Default: 00h

- D[7:6]     **PDN CHA and PDN CHB**     Power-down channels A and B. Effective only when bit DIS CTRL PINS is set to '1'.
  - 00       Normal operation
  - 01       Channel B powers down. Use only if the QDR interface is selected. Do not use in the DDR interface.
  - 10       Channel A powers down. Functions in both QDR and DDR interfaces.
  - 11       Both channels power down. Functions in both QDR and DDR interfaces.
  
- D5       **STDBY**                 Dual ADC is placed into standby mode
  - 0       Normal operation
  - 1       Power down
  
- D4       **DATA FORMAT**        Digital output data format
  - 0       Twos complement
  - 1       Offset binary
  
- D3       **DIS CTRL PINS**       Disables power-down control from CTRL1, CTRL2 pins. This bit also functions as an enable bit for the INV CLK OUT CHA, INV CLK OUT CHB, and DDR OUTPUT TIMING bits.
  - 0       CTRL1 and CTRL2 pins control power-down options for channels A and B
  - 1       Register bits PDN CHA and PDN CHB determine power-down options for channels A and B. Register bits INV CLK OUT CHA, INV CLK OUT CHB, and DDR OUTPUT TIMING become effective.
  
- D2       **TEST PAT ALIGN**     Aligns test patterns of two channels
  - 0       Test patterns for channel A and channel B are free running
  - 1       Test patterns for both channels are synchronized
  
- D0       **RESET**                 Software reset applied
  - This bit resets all internal registers to the default values and self-clears to '0'

REGISTER ADDRESS	REGISTER DATA							
A7-A0 IN HEX	D7	D6	D5	D4	D3	D2	D1	D0
B	CHA GAIN					CHA GAIN EN	0	FLIP DATA

Default: 00h

D[7:3]      **CHA GAIN**      Digital gain for channel A. Effective when register bit CHA GAIN EN is set to '1'. Bit descriptions are listed in [Table 9](#).

**Table 9. Digital Gain for Channel A**

DIGITAL GAIN FOR CHANNEL A	DIGITAL GAIN (dB)	MAX INPUT VOLTAGE (V <sub>PP</sub> )		DIGITAL GAIN FOR CHANNEL A	DIGITAL GAIN (dB)	MAX INPUT VOLTAGE (V <sub>PP</sub> )
00000	0	<b>2.0</b>		01010	1.5	1.7
00001	Do not use	—		01011	2	1.6
00010	Do not use	—		01100	2.5	1.5
00011	–2.0	<b>2.5</b>		01101	3	1.4
00100	–1.5	2.4		01110	3.5	1.3
00101	–1.0	2.2		01111	4	1.25
00110	–0.5	2.1		10000	4.5	1.2
00111	0	<b>2.0</b>		10001	5	1.1
01000	0.5	1.9		10010	5.5	1.05
01001	1	1.8		10011	6	1.0

D2      **CHA GAIN EN**      Digital gain enable bit for channel A

0      Digital gain disabled

1      Digital gain enabled

D0      **FLIP DATA**      Flips bit order on LVDS output bus (LSB versus MSB)

0      Normal operation

1      Output bus flipped. In the ADS42LB69, output data bit D0 becomes D15, D1 becomes D14, and so forth. In the ADS42LB49, output data bit D0 becomes D13, D1 becomes D12, and so forth.

REGISTER ADDRESS	REGISTER DATA							
A7-A0 IN HEX	D7	D6	D5	D4	D3	D2	D1	D0
C	CHB GAIN					CHB GAIN EN	OVR ON LSB	

Default: 00h

D[7:3] **CHB GAIN** Digital gain for channel B. Effective when register bit CHB GAIN EN is set to '1'. Bit descriptions are listed in [Table 10](#).

**Table 10. Digital Gain for Channel B**

DIGITAL GAIN FOR CHANNEL B	DIGITAL GAIN (dB)	MAX INPUT VOLTAGE (V <sub>PP</sub> )	DIGITAL GAIN FOR CHANNEL B	DIGITAL GAIN (dB)	MAX INPUT VOLTAGE (V <sub>PP</sub> )
00000	0	2.0	01010	1.5	1.7
00001	Do not use	—	01011	2	1.6
00010	Do not use	—	01100	2.5	1.5
00011	-2.0	2.5	01101	3	1.4
00100	-1.5	2.4	01110	3.5	1.3
00101	-1.0	2.2	01111	4	1.25
00110	-0.5	2.1	10000	4.5	1.2
00111	0	2.0	10001	5	1.1
01000	0.5	1.9	10010	5.5	1.05
01001	1	1.8	10011	6	1.0

D2 **CHB GAIN EN** Digital gain enable bit for channel B

0 Digital gain disabled

1 Digital gain disabled

D[1:0] **OVR ON LSB** Functions only with the DDR interface option. Replaces the LSB pair of 16-bit data (D1, D0) with OVR information. See the [Oversample Indication](#) section.

00 D1 and D0 are output in the ADS42LB69, NC for the ADS42LB49

01 Fast OVR in LVDS logic level

10 Normal OVR in LVDS logic level

11 D1 and D0 are output in the ADS42LB69, NC for the ADS42LB49

REGISTER ADDRESS	REGISTER DATA							
A7-A0 IN HEX	D7	D6	D5	D4	D3	D2	D1	D0
D	0	1	1	0	1	1	0	FAST OVR ON PIN

Default:

6Ch

D0 **FAST OVR ON PIN** Determines whether normal OVR or fast OVR information is brought on the OVRx, CTRL1, and CTRL2 pins. See the [Oversample Indication](#) section.

0 Normal OVR available on the OVRx, CTRL1, and CTRL2 pins

1 Fast OVR available on the OVRx, CTRL1, and CTRL2 pins

REGISTER ADDRESS	REGISTER DATA							
	D7	D6	D5	D4	D3	D2	D1	D0
F	CHA TEST PATTERNS				CHB TEST PATTERNS			

Default: 00h

D[7:4]	<b>CHA TEST PATTERNS</b>	Channel A test pattern programmability
0000	Normal Operation	
0001	Outputs all 0s	
0010	Outputs all 1s	
0011	Outputs toggle pattern:	In the ADS42LB69, data are an alternating sequence of <i>1010101010101010</i> and <i>0101010101010101</i> . In the ADS42LB49, data alternate between <i>1010101010101010</i> and <i>0101010101010101</i> .
0100	Output digital ramp:	In the ADS42LB69, data increment by 1 LSB every clock cycle from code 0 to 65535. In the ADS42LB49 data increment by 1 LSB every fourth clock cycle from code 0 to 16383.
0101	Increment pattern:	Do not use
0110	Single pattern:	In the ADS42LB69, data are the same as programmed by registers bits CUSTOM PATTERN 1[15:0]. In the ADS42LB49, data are the same as programmed by register bits CUSTOM PATTERN 1[15:2].
0111	Double pattern:	In the ADS42LB69, data alternate between CUSTOM PATTERN 1[15:0] and CUSTOM PATTERN 2[15:0]. In the ADS42LB49 data alternate between CUSTOM PATTERN 1[15:2] and CUSTOM PATTERN 2[15:2].
1000	Deskew pattern:	In the ADS42LB69, data are AAAAh. In the ADS42LB49, data are 3AAAh.
1001	Do not use	
1010	PRBS pattern:	Data are a sequence of pseudo-random numbers
1011	8P sine:	In the ADS42LB69, data are a repetitive sequence of the following eight numbers, forming a sine-wave in twos complement format: 1, 9598, 32768, 55938, 65535, 55938, 32768, and 9598. In the ADS42LB49, data are a repetitive sequence of the following eight numbers, forming a sine-wave in twos complement format: 0, 2399, 8192, 13984, 16383, 13984, 8192, and 2399.
D[3:0]	<b>CHB TEST PATTERNS</b>	Channel B test pattern programmability
0000	Normal Operation	
0001	Outputs all 0s	
0010	Outputs all 1s	
0011	Outputs toggle pattern:	In the ADS42LB69, data are an alternating sequence of <i>1010101010101010</i> and <i>0101010101010101</i> . In the ADS42LB49, data alternate between <i>1010101010101010</i> and <i>0101010101010101</i> .
0100	Output digital ramp:	In the ADS42LB69, data increment by 1 LSB every clock cycle from code 0 to 65535. In the ADS42LB49 data increment by 1 LSB every fourth clock cycle from code 0 to 16383.
0101	Increment pattern:	Do not use
0110	Single pattern:	In the ADS42LB69, data are the same as programmed by registers bits CUSTOM PATTERN 1[15:0]. In the ADS42LB49, data are the same as programmed by register bits CUSTOM PATTERN 1[15:2].
0111	Double pattern:	In the ADS42LB69, data alternate between CUSTOM PATTERN 1[15:0] and CUSTOM PATTERN 2[15:0]. In the ADS42LB49 data alternate between CUSTOM PATTERN 1[15:2] and CUSTOM PATTERN 2[15:2].
1000	Deskew pattern:	In the ADS42LB69, data are AAAAh. In the ADS42LB49, data are 3AAAh.
1001	Do not use	
1010	PRBS pattern:	Data are a sequence of pseudo-random numbers
1011	8P sine:	In the ADS42LB69, data are a repetitive sequence of the following eight numbers, forming a sine-wave in twos complement format: 1, 9598, 32768, 55938, 65535, 55938, 32768, and 9598. In the ADS42LB49, data are a repetitive sequence of the following eight numbers, forming a sine-wave in twos complement format: 0, 2399, 8192, 13984, 16383, 13984, 8192, and 2399.

REGISTER ADDRESS	REGISTER DATA							
A7-A0 IN HEX	D7	D6	D5	D4	D3	D2	D1	D0
10	CUSTOM PATTERN 1 (15:8)							

Default: 00h

D[7:0] **CUSTOM PATTERN 1 (15:8)** Sets the custom pattern 1[15:8] with these bits for both channels

REGISTER ADDRESS	REGISTER DATA							
A7-A0 IN HEX	D7	D6	D5	D4	D3	D2	D1	D0
11	CUSTOM PATTERN 1 (7:0)							

Default: 00h

D[7:0] **CUSTOM PATTERN 1 (7:0)** Sets the custom pattern 1[7:0] with these bits for both channels

REGISTER ADDRESS	REGISTER DATA							
A7-A0 IN HEX	D7	D6	D5	D4	D3	D2	D1	D0
12	CUSTOM PATTERN 2 (15:8)							

Default: 00h

D[7:0] **CUSTOM PATTERN 2 (15:8)** Sets the custom pattern 2[15:8] with these bits for both channels

REGISTER ADDRESS	REGISTER DATA							
A7-A0 IN HEX	D7	D6	D5	D4	D3	D2	D1	D0
13	CUSTOM PATTERN 2 (7:0)							

Default: 00h

D[7:0] **CUSTOM PATTERN 2 (7:0)** Sets the custom pattern 2[7:0] with these bits for both channels

REGISTER ADDRESS	REGISTER DATA							
A7-A0 IN HEX	D7	D6	D5	D4	D3	D2	D1	D0
14	0	0	0	0	LVDS CLK STRENGTH	LVDS DATA STRENGTH	DISABLE OUTPUT CHA	DISABLE OUTPUT CHB

Default: 00h

D3 **LVDS CLK STRENGTH** Increases the LVDS drive strength of the CLKOUTP, CLKOUTM buffers in the DDR pinout and the DxCLKP, DxCLKM buffers in the QDR pinout

0 LVDS output clock buffer at default strength used with 100-Ω external termination

1 LVDS output clock buffer has double strength used with 50-Ω external termination. Effective only when bit LVDS CLK STRENGTH EN is set to '1'.

D2 **LVDS DATA STRENGTH** Increases the LVDS drive strength

0 LVDS output data buffers (including frame clock buffers in the QDR interface) at default strength used with a 100-Ω external termination

1 LVDS output data buffers (including frame clock buffers in the QDR interface) at double strength used with a 50-Ω external termination

D1 **DISABLE OUTPUT CHA** Disables LVDS output buffers of channel A

0 Normal operation

1 Channel A output buffers are in 3-state

D0 **DISABLE OUTPUT CHB** Disables LVDS output buffers of channel B

0 Normal operation

1 Channel B output buffers are in 3-state

REGISTER ADDRESS	REGISTER DATA							
A7-A0 IN HEX	D7	D6	D5	D4	D3	D2	D1	D0
15	0	0	0	0	0	0	0	DDR - QDR

Default: 00h

**D0 DDR – QDR** Selects output interface between DDR and QDR LVDS mode  
 0 QDR LVDS mode  
 1 DDR LVDS mode

REGISTER ADDRESS	REGISTER DATA							
A7-A0 IN HEX	D7	D6	D5	D4	D3	D2	D1	D0
16	0	0	DDR OUTPUT TIMING					0

Default: 00h

**D[5:1] DDR OUTPUT TIMING** Effective only when bit DIS CTRL PINS is set to '1'. Bit descriptions are listed in [Table 11](#).

**Table 11. DDR Output Timing (After Setting bits DIS CTRL PINS to '1')**

BIT SETTING	DELAY (ps) IN OUTPUT CLOCK WITH RESPECT TO DEFAULT POSITION			
	$f_s = 250$ MSPS	$f_s = 200$ MSPS	$f_s = 150$ MSPS	$f_s = 100$ MSPS
00101	–180	–220	–310	–440
00111	–100	–130	–190	–260
00000	0	0	0	0
01101	120	130	170	260
01110	230	240	330	520
01011	320	360	480	740
10100	400	460	620	940
10000	500	600	790	1220

Register Address	Register Data							
A7-A0 IN HEX	D7	D6	D5	D4	D3	D2	D1	D0
17	LVDS CLK STRENGTH EN	0	QDR OUTPUT TIMING CHA					INVCLK OUT CHA

Default: 00h

**D7 LVDS CLK STRENGTH EN**

0 Default

1 Enables clock strength programmability with LVDS CLK STRENGTH bit

**D[5:1] QDR OUTPUT TIMING CHA** Adjusts position of output data clock on chA with respect to output data. Bit settings are listed in [Table 12](#).

**D0 INV CLK OUT CHA** Inverts polarity of the output clock for channel A (QDR mode only)

0 Normal operation

1 Polarity of channel A output clock DACLKP, DACLKM is inverted. Effective only when bit DIS CTRL PINS is set to '1'.

**Table 12. QDR Timing Channel A Timing**

BIT SETTING	DELAY (ps) IN OUTPUT CLOCK WITH RESPECT TO DEFAULT POSITION			
	f <sub>s</sub> = 250 MSPS	f <sub>s</sub> = 200 MSPS	f <sub>s</sub> = 150 MSPS	f <sub>s</sub> = 100 MSPS
00101	-80	-120	-150	-225
00111	-55	-75	-90	-130
00000	0	0	0	0
01101	55	65	90	130
01110	95	115	165	235
01011	140	165	230	350
10100	180	220	290	450
10000	230	290	370	565

REGISTER ADDRESS	REGISTER DATA								
A7-A0 IN HEX	D7	D6	D5	D4	D3	D2	D1	D0	
18	0	0	QDR OUTPUT TIMING CHB					INVCLK OUT CHB	

Default: 00h

D[5:1] **QDR OUTPUT TIMING CHB** Adjusts position of output data clock on chB with respect to output data. Bit settings are listed in [Table 13](#).

D0 **INV CLK OUT CHB** Inverts output clock polarity for channel B in QDR mode, or output clock CLKOUTP, CLKOUTM in DDR mode.

0 Normal operation

1 In QDR mode, the polarity of the channel B output clock DBCLKP, DBCLKM is inverted. Effective only when bit DIS CTRL PINS is set to '1'. In DDR mode, the output clock polarity of CLKOUTP, CLKOUTM is inverted.

**Table 13. QDR Timing Channel B Timing**

BIT SETTING	DELAY (ps) IN OUTPUT CLOCK WITH RESPECT TO DEFAULT POSITION			
	$f_s = 250$ MSPS	$f_s = 200$ MSPS	$f_s = 150$ MSPS	$f_s = 100$ MSPS
00101	-80	-120	-150	-225
00111	-55	-75	-90	-130
00000	0	0	0	0
01101	55	65	90	130
01110	95	115	165	235
01011	140	165	230	350
10100	180	220	290	450
10000	230	290	370	565

REGISTER ADDRESS	REGISTER DATA							
A7-A0 IN HEX	D7	D6	D5	D4	D3	D2	D1	D0
1F	Always write '0'	FAST OVR THRESHOLD						

Default: FFh

D7 **Always write '0'**

Default value of this bit is '1'. Always write this bit to '0' when fast OVR thresholds are programmed.

D[6:0] **FAST OVR THRESHOLD**

The device has a fast OVR mode that indicates an overload condition at the ADC input. The input voltage level at which the overload is detected is referred to as the threshold and is programmable using the FAST OVR THRESHOLD bits. FAST OVR is triggered nine output clock cycles after the overload condition occurs. The threshold at which fast OVR is triggered is (full-scale x [the decimal value of the FAST OVR THRESHOLD bits] / 127). See the [Overrange Indication](#) section for details.

REGISTER ADDRESS	REGISTER DATA							
A7-A0 IN HEX	D7	D6	D5	D4	D3	D2	D1	D0
20	0	0	0	0	0	0	0	PDN/OVR FOR CTRL PINS

Default: 00h

D0 **PDN/OVR FOR CTRL PINS** Determines if the CTRL1, CTRL2 pins are power-down control or OVR outputs

0 CTRL1 and CTRL2 pins function as input pins to control power-down operation.

1 CTRL1 and CTRL2 pins function as output pins for overrange indications of channels A and B, respectively. Register bits PDN CH A, PDN CH B along with DIS CTRL PINS can be used for power-down operation.

## APPLICATION INFORMATION

### THEORY OF OPERATION

The ADS42LB69 and ADS42LB49 is a family of high linearity, buffered analog input, dual-channel ADCs with maximum sampling rates up to 250 MSPS employing either a quadruple data rate (QDR) or double data rate (DDR) LVDS interface. The conversion process is initiated by a rising edge of the external input clock and the analog input signal is sampled. The sampled signal is sequentially converted by a series of small resolution stages, with the outputs combined in a digital correction logic block. At every clock edge the sample propagates through the pipeline, resulting in a data latency of 14 clock cycles. The output is available in LVDS logic levels in SPI-programmable QDR or DDR options.

### ANALOG INPUT

The analog input pins have analog buffers (running from the AVDD3V supply) that internally drive the differential sampling circuit. As a result of the analog buffer, the input pins present high input impedance to the external driving source (at dc, a 10-k $\Omega$  differential input resistance is provided in shunt with a 4-pF differential input capacitance). The buffer helps isolate the external driving source from the switching currents of the sampling circuit. This buffering makes driving the buffered inputs easier than when compared to an ADC without the buffer.

The input common-mode is set internally using a 5-k $\Omega$  resistor from each input pin to VCM so the input signal can be ac-coupled to the pins. Each input pin (INP, INM) must swing symmetrically between VCM + 0.5 V and VCM – 0.5 V, resulting in a 2-V<sub>PP</sub> differential input swing. When programmed for 2.5-V<sub>PP</sub> full-scale, each input pin must swing symmetrically between VCM + 0.625 V and VCM – 0.625 V.

The input sampling circuit has a high 3-dB bandwidth that extends up to 900 MHz (measured with a 50- $\Omega$  source driving a 50- $\Omega$  termination between INP and INM). The dynamic offset of the first-stage sub-ADC limits the maximum analog input frequency to approximately 250 MHz (with a 2.5-V<sub>PP</sub> full-scale amplitude) and to approximately 400 MHz (with a 2-V<sub>PP</sub> full-scale amplitude). This maximum analog input frequency is different than the analog bandwidth of 900 MHz, which is only an indicator of signal amplitude versus frequency.

### Drive Circuit Requirements

For optimum performance, the analog inputs must be driven differentially. This technique improves the common-mode noise immunity and even-order harmonic rejection. A small resistor (10  $\Omega$ ) in series with each input pin is recommended to damp out ringing caused by package parasitics.

Figure 85, Figure 86, and Figure 87 show the differential impedance ( $Z_{IN} = R_{IN} \parallel C_{IN}$ ) at the ADC input pins. The presence of the analog input buffer results in an almost constant input capacitance up to 1 GHz.

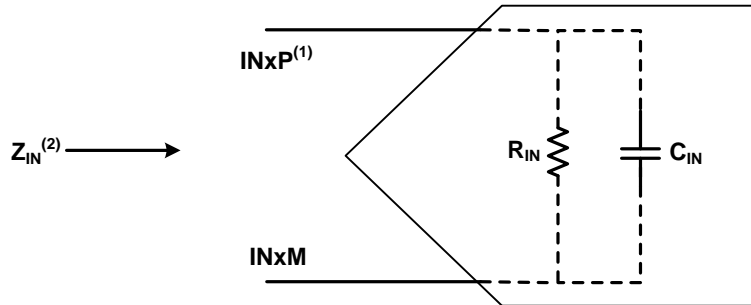

- (1) X = A or B.
- (2)  $Z_{IN} = R_{IN} \parallel (1 / j\omega C_{IN})$ .

**Figure 85. ADC Equivalent Input Impedance**

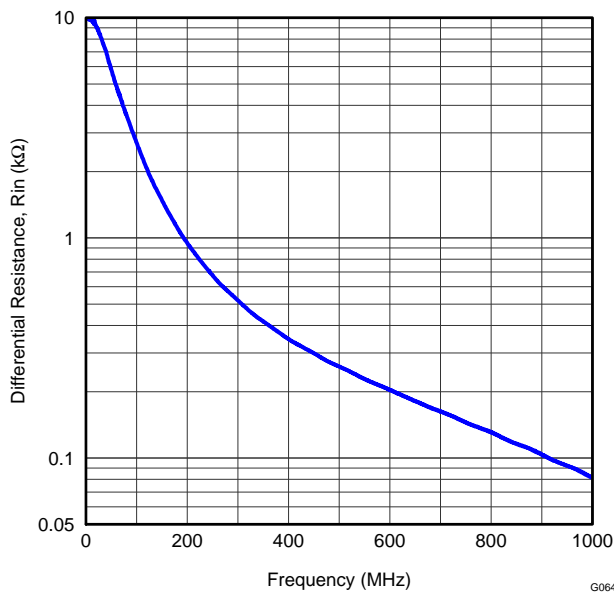

**Figure 86. ADC Analog Input Resistance ( $R_{IN}$ ) Across Frequency**

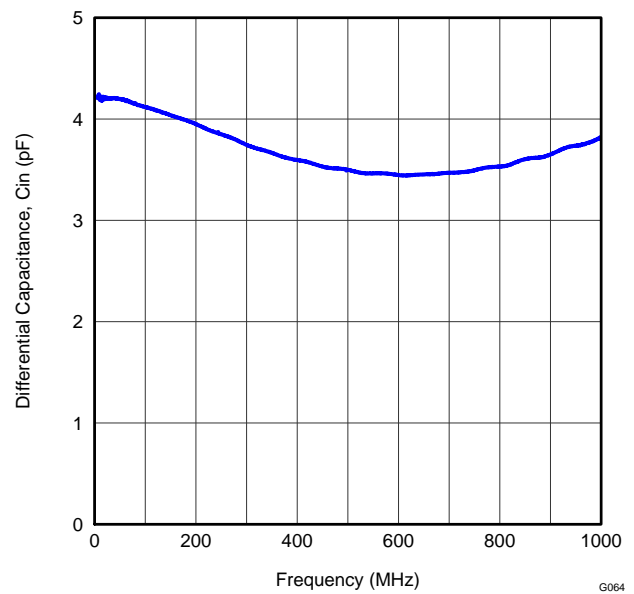

**Figure 87. ADC Analog Input Capacitance ( $C_{IN}$ ) Across Frequency**

### Driving Circuit

An example driving circuit configuration is shown in [Figure 88](#). To optimize even-harmonic performance at high input frequencies (greater than the first Nyquist), the use of back-to-back transformers is recommended, as shown in [Figure 88](#). Note that the drive circuit is terminated by 50 Ω near the ADC side. The ac-coupling capacitors allow the analog inputs to self-bias around the required common-mode voltage. If HD2 optimization is a concern, using a 10-Ω series resistor on the INP side and a 9.5-Ω series resistor on the INM side may help improve HD2 by 2 dB to 3 dB at a 85-dBFS level on a 170-MHz IF. An additional R-C-R (39 Ω - 6.8 pF - 39 Ω) circuit placed near device pins helps further improve HD3.

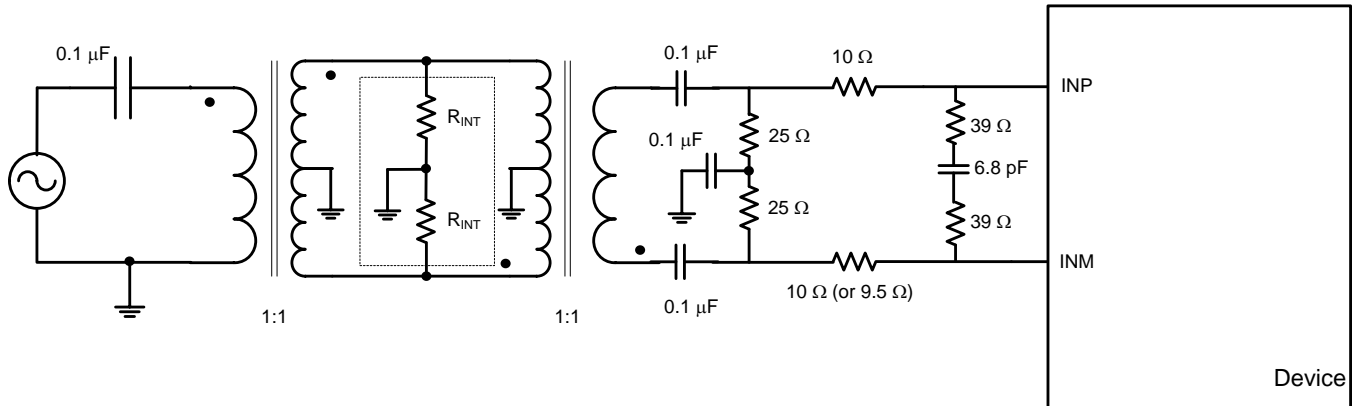

**Figure 88. Drive Circuit for Input Frequencies Up to 250 MHz**

The mismatch in the transformer parasitic capacitance (between the windings) results in degraded even-order harmonic performance. Connecting two identical RF transformers back-to-back helps minimize this mismatch and good performance is obtained for high-frequency input signals. An additional termination resistor pair may be required between the two transformers, as shown in [Figure 88](#). The center point of this termination is connected to ground to improve the balance between the P (positive) and M (negative) sides. The values of the terminations between the transformers and on the secondary side must be chosen to obtain an effective 50 Ω (for a 50-Ω source impedance). For high input frequencies (>250MHz), the R-C-R circuit can be removed as indicated in [Figure 89](#).

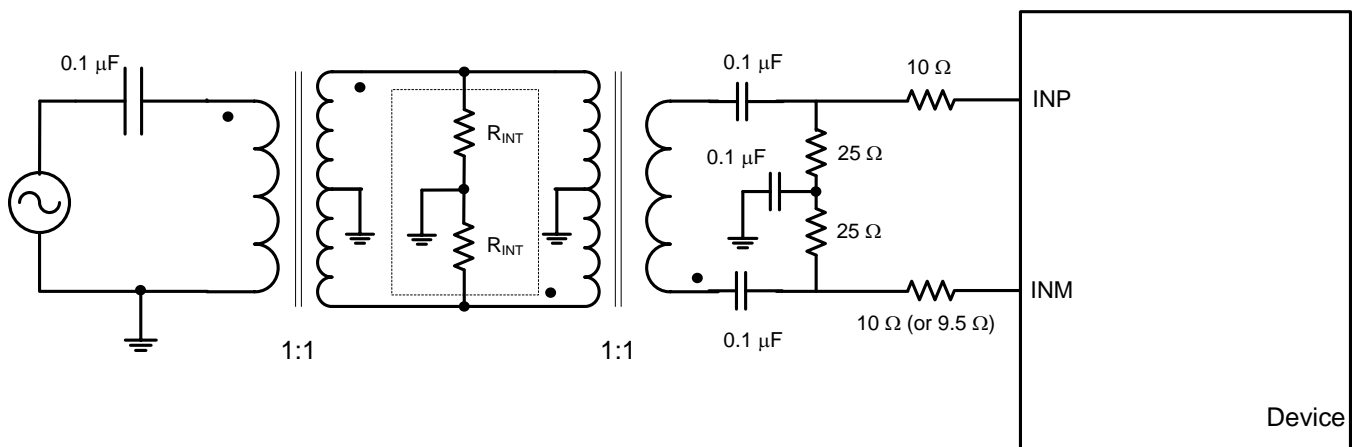

**Figure 89. Drive Circuit for Input Frequencies > 250 MHz**

## CLOCK INPUT

The device clock inputs can be driven differentially (sine, LVPECL, or LVDS) or single-ended (LVCMOS), with little or no difference in performance between them. The common-mode voltage of the clock inputs is set to 1.4 V using internal 5-k $\Omega$  resistors. The self-bias clock inputs of the ADS42LB69 and ADS42LB49 can be driven by the transformer-coupled, sine-wave clock source or by the ac-coupled, LVPECL and LVDS clock sources, as shown in Figure 90, Figure 91, and Figure 92. See Figure 92 for details regarding the internal clock buffer.

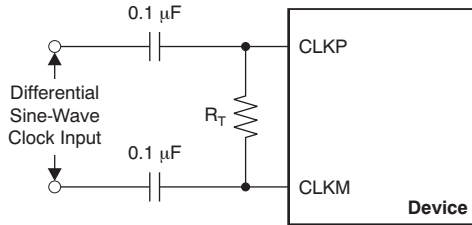

NOTE:  $R_T$  = termination resistor, if necessary.

Figure 90. Differential Sine-Wave Clock Driving Circuit

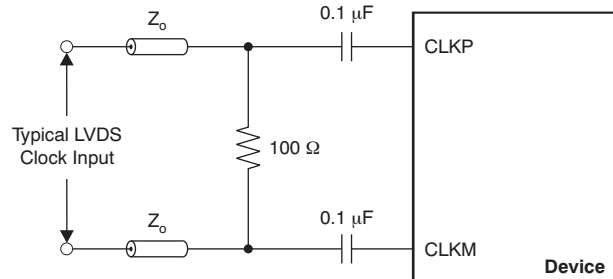

Figure 91. LVDS Clock Driving Circuit

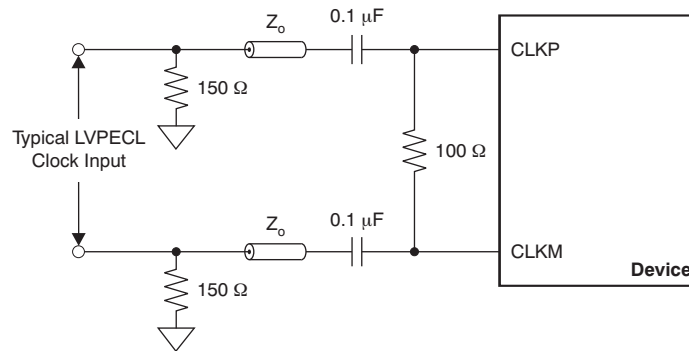
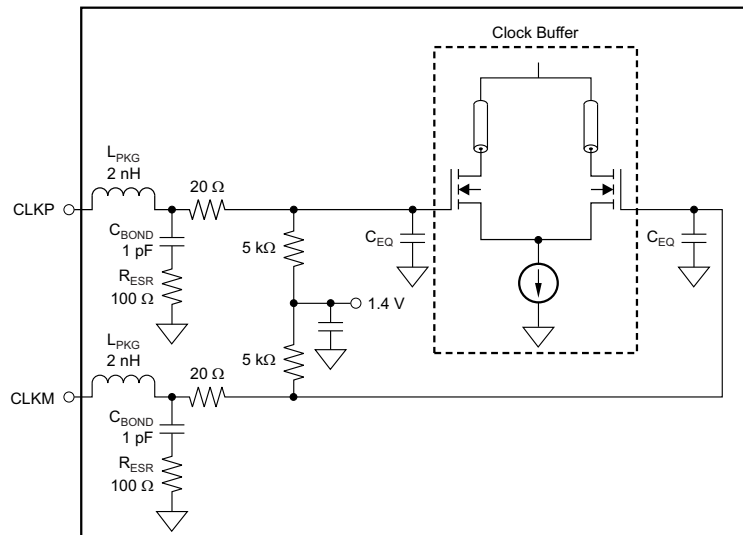

Figure 92. LVPECL Clock Driving Circuit



NOTE:  $C_{EQ}$  is 1 pF to 3 pF and is the equivalent input capacitance of the clock buffer.

Figure 93. Internal Clock Buffer

A single-ended CMOS clock can be ac-coupled to the CLKP input, with CLKM connected to ground with a 0.1- $\mu$ F capacitor, as shown in Figure 94. However, for best performance the clock inputs must be driven differentially, thereby reducing susceptibility to common-mode noise. For high input frequency sampling, TI recommends using a clock source with very low jitter. Band-pass filtering of the clock source can help reduce the effects of jitter. There is no change in performance with a non-50% duty cycle clock input.

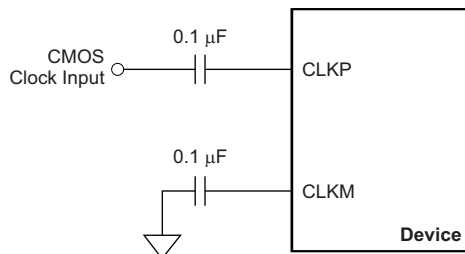

Figure 94. Single-Ended Clock Driving Circuit

## DIGITAL GAIN

The device includes gain settings that can be used to obtain improved SFDR performance (compared to no gain). Gain is programmable from  $-2$  dB to 6 dB (in 0.5-dB steps). For each gain setting, the analog input full-scale range scales proportionally. Table 14 shows how full-scale input voltage changes when digital gain are programmed in 1-dB steps. Refer to Table 9 to set digital gain using a serial interface register.

SFDR improvement is achieved at the expense of SNR; for a 1-dB increase in digital gain, SNR degrades approximately between 0.5 dB and 1 dB (refer to Figure 25 and Figure 26). Therefore, gain can be used as a trade-off between SFDR and SNR. Note that the default gain after reset is 0 dB with a  $2.0\text{-}V_{PP}$  full-scale voltage.

Table 14. Full-Scale Range Across Gains

DIGITAL GAIN	FULL-SCALE INPUT VOLTAGE
$-2$ dB	$2.5 V_{PP}^{(1)}$
$-1$ dB	$2.2 V_{PP}$
0 dB (default)	$2.0 V_{PP}$
1 dB	$1.8 V_{PP}$
2 dB	$1.6 V_{PP}$
3 dB	$1.4 V_{PP}$
4 dB	$1.25 V_{PP}$
5 dB	$1.1 V_{PP}$
6 dB	$1.0 V_{PP}$

(1) Shaded cells indicate performance settings used in the Electrical Characteristics and Typical Characteristics.

## OVERRANGE INDICATION

The device provides two different overrange indications: normal OVR and fast OVR. Normal OVR (default) is triggered if the final 16-bit data output exceeds the maximum code value. Normal OVR latency is the same as the output data (that is, 14 clock cycles). Fast OVR is triggered if the input voltage exceeds the programmable overrange threshold and is presented after a latency of only nine clock cycles, thus enabling a quicker reaction to an overrange event.

### OVR In a QDR Pinout

In a QDR interface, the overrange indication is output on the OVRA and OVRB pins (pin 54 and 59) in 1.8-V CMOS logic levels. The same overrange indication can also be made available on the bidirectional CTRL1, CTRL2 pins by using the PDN/OVR FOR CTRL PINS register bit, as described in [Figure 95](#). Using the FAST OVR EN register bit, the fast OVR indication can be presented on these pins instead of normal OVR.

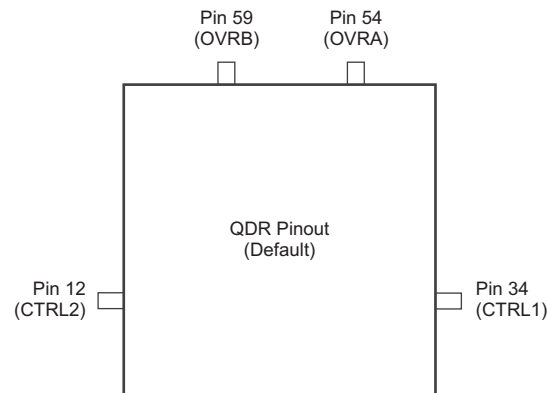

NOTE: By default, normal OVR is output on the OVRA and OVRB pins. Using the FAST OVR EN register bit, fast OVR can be presented on these pins instead.

NOTE: When the PDN/OVR FOR CTRL PINS register bit is set, the CTRL1 and CTRL2 pins function as output pins and carry the same information as the OVRA and OVRB pins (respectively) in 1.8-V CMOS logic levels.

**Figure 95. OVR In a QDR Pinout**

### OVR In a DDR Pinout

In the DDR interface, there are no dedicated pins to provide overrange indication. However, by choosing the appropriate register bits, OVR can be transferred on the LSB of 16-bit output data as well as on the bidirectional CTRL1 and CTRL2 pins, as shown in [Figure 96](#).

Use the OVR ON LSB register bits to transfer channel A and channel B OVR information. Channel A OVR information is transferred on pins 39 and 40 in LVDS logic levels. Channel B OVR information is transferred on pins 9 and 10. Note that these pins are Dx0P, Dx0M in the ADS42LB69 and are NC in the ADS42LB49.

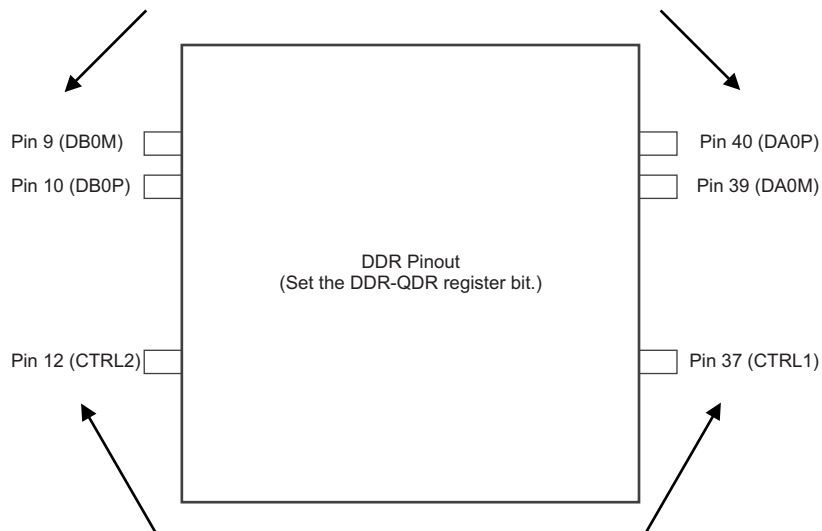

By default, the DDR pinout does not provide OVR information. Use the PDN/OVR FOR CTRL PINS register bit to transfer OVR information. Channel A OVR information is transferred on the CTRL1 pin and channel B OVR information is transferred on the CTRL2 pin in 1.8-V CMOS logic levels.

**Figure 96. OVR In a DDR Pinout**

The FAST OVR EN register bit can be used to transfer fast OVR indication on the CTRL1 and CTRL2 pins instead of normal OVR. The OVR ON LSB register bits can be used to transfer fast OVR indication on the LSB bits (Dx0P, Dx0M), as described in [Table 15](#).

**Table 15. Fast OVR Transfer**

OVR ON LSB BIT SETTINGS	PIN STATE FOR PINS 9, 10 AND 39, 40
00	D0 and D1 are output in the ADS42LB69, NC for the ADS42LB49
01	Fast OVR in LVDS logic level
10	Normal OVR in LVDS logic level
11	D0 and D1 are output in the ADS42LB69, NC for the ADS42LB49

Table 16 summarizes the availability of OVR information on different pins in the QDR and DDR interfaces and the required register settings.

**Table 16. OVR Information Availability**

INTERFACE	SETTINGS	OVR INFORMATION AVAILABILITY		
		PINS 9, 10 AND 39, 40 (LVDS Logic Levels)	PINS 12 AND 37 (CMOS Logic Levels)	PINS 54 AND 59 (CMOS Logic Levels)
QDR	Default	Not applicable	No	Yes
	Use the PDN/OVR FOR CTRL PINS register bits	Not applicable	Yes	Yes
DDR	Default	No	No	Not applicable
	Use the OVR ON LSB register bits	Yes	No	Not applicable
	Use the PDN/OVR FOR CTRL PINS register bits	No	Yes	Not applicable
	Use the OVR ON LSB and PDN/OVR FOR CTRL PINS register bits	Yes	Yes	Not applicable

### Programming Threshold for Fast OVR

The input voltage level at which the overload is detected is referred to as the threshold and is programmable using the FAST OVR THRESHOLD bits. Fast OVR is triggered nine output clock cycles after the overload condition occurs. The threshold voltage amplitude at which fast OVR is triggered is Equation 1:

$$1 \times [\text{the decimal value of the FAST OVR THRESH bits}] / 127 \tag{1}$$

When digital gain is programmed (for gain values > 0 dB), the threshold voltage amplitude is Equation 2:

$$10^{-\text{Gain} / 20} \times [\text{the decimal value of the FAST OVR THRESH bits}] / 127 \tag{2}$$

### SNR AND CLOCK JITTER

The signal-to-noise ratio (SNR) of the ADC is limited by three different factors, as shown in Equation 3. Quantization noise is typically not noticeable in pipeline converters and is 96 dBFS for a 16-bit ADC. Thermal noise limits SNR at low input frequencies and clock jitter sets SNR for higher input frequencies.

$$\text{SNR}_{\text{ADC}}[\text{dBc}] = -20 \times \log \sqrt{\left(10 - \frac{\text{SNR}_{\text{Quantization\_Noise}}}{20}\right)^2 + \left(10 - \frac{\text{SNR}_{\text{ThermalNoise}}}{20}\right)^2 + \left(10 - \frac{\text{SNR}_{\text{Jitter}}}{20}\right)^2} \tag{3}$$

SNR limitation is a result of sample clock jitter and can be calculated by Equation 4:

$$\text{SNR}_{\text{Jitter}}[\text{dBc}] = -20 \times \log(2\pi \times f_{\text{IN}} \times t_{\text{jitter}}) \tag{4}$$

The total clock jitter ( $T_{\text{Jitter}}$ ) has three components: the internal aperture jitter ( $85 f_s$  for the device) is set by the noise of the clock input buffer, the external clock jitter, and the jitter from the analog input signal.  $T_{\text{Jitter}}$  can be calculated by Equation 5:

$$T_{\text{Jitter}} = \sqrt{(T_{\text{Jitter,Ext.Clock\_Input}})^2 + (T_{\text{Aperture\_ADC}})^2} \tag{5}$$

External clock jitter can be minimized by using high-quality clock sources and jitter cleaners as well as band-pass filters at the clock input while a faster clock slew rate improves ADC aperture jitter. The device has a 74.1-dBFS thermal noise and an  $85\text{-}f_s$  internal aperture jitter. The SNR value depends on the amount of external jitter for different input frequencies, as shown in Figure 97.

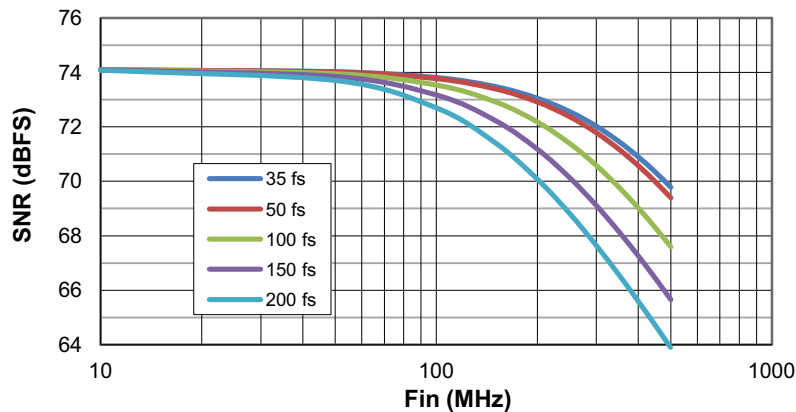

Figure 97. SNR versus Input Frequency and External Clock Jitter

## INPUT CLOCK DIVIDER

The device is equipped with an internal divider on the clock input. This divider allows operation with a faster input clock, simplifying the system clock distribution design. The clock divider can be bypassed (divide-by-1) for operation with a 250-MHz clock. The divide-by-2 option supports a maximum 500-MHz input clock and the divide-by-4 option supports a maximum 1-GHz input clock frequency.

## DIGITAL OUTPUT INFORMATION

The ADS42LB49 and ADS42LB69 provides 14- and 16-bit digital data for each channel and output clock synchronized with the data.

### Output Interface

Digital outputs are available in quadruple data rate (QDR) LVDS, and double data rate (DDR) LVDS formats, selectable by the DDR - QDR serial register bit.

### DDR LVDS Outputs

In this mode, the data bits and clock are output using low-voltage differential signal (LVDS) levels. Two data bits are multiplexed and output on each LVDS differential pair, as shown in [Figure 98](#).

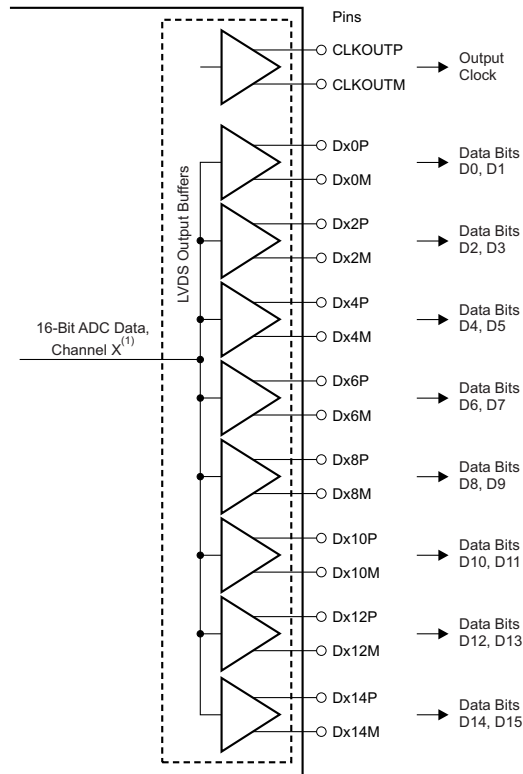

(1) X = A or B (for channel A or channel B).

**Figure 98. DDR LVDS Interface**

Even data bits (D0, D2, D4, and so forth) are output at the CLKOUTP rising edge and the odd data bits (D1, D3, D5, and so forth) are output at the CLKOUTP falling edge. Both the CLKOUTP rising and falling edges must be used to capture all the data bits, as shown in Figure 99.

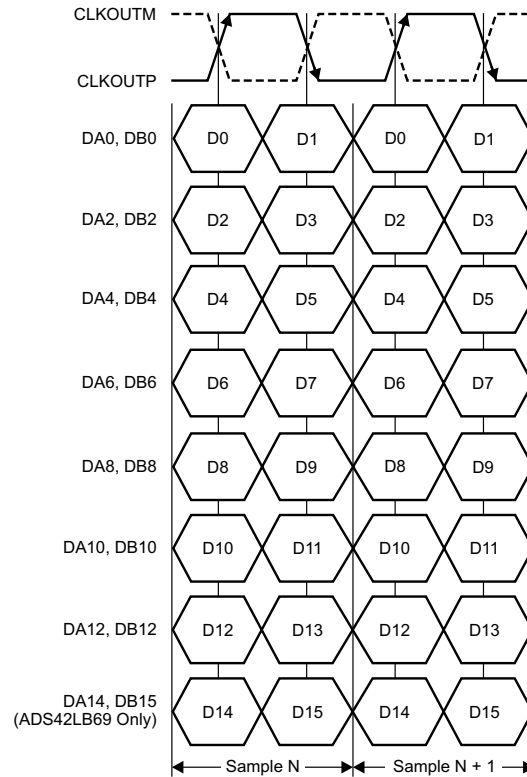

**Figure 99. DDR LVDS Interface Timing**

**QDR LVDS Outputs**

The data bits and output clocks are output using low-voltage differential signal (LVDS) levels. Four data bits are multiplexed and output on each LVDS differential data pair and are accompanied by a bit clock and a frame clock for each channel, as shown in [Figure 100](#).

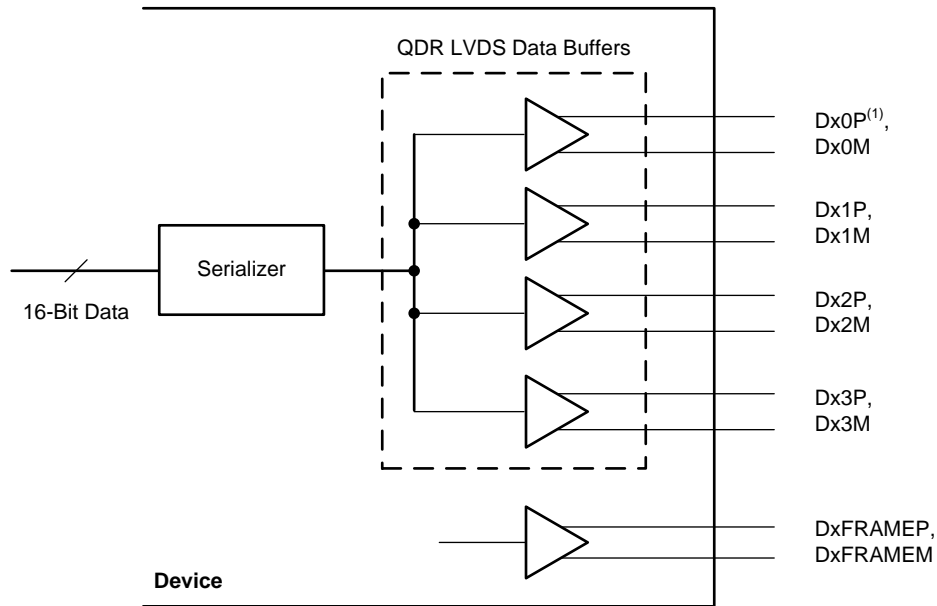

(1) X = channels A and B.

**Figure 100. QDR LVDS Interface**

Figure 101 shows the QDR interface bit order for the ADS42LB69 and Figure 102 shows the QDR interface bit order for the ADS42LB49.

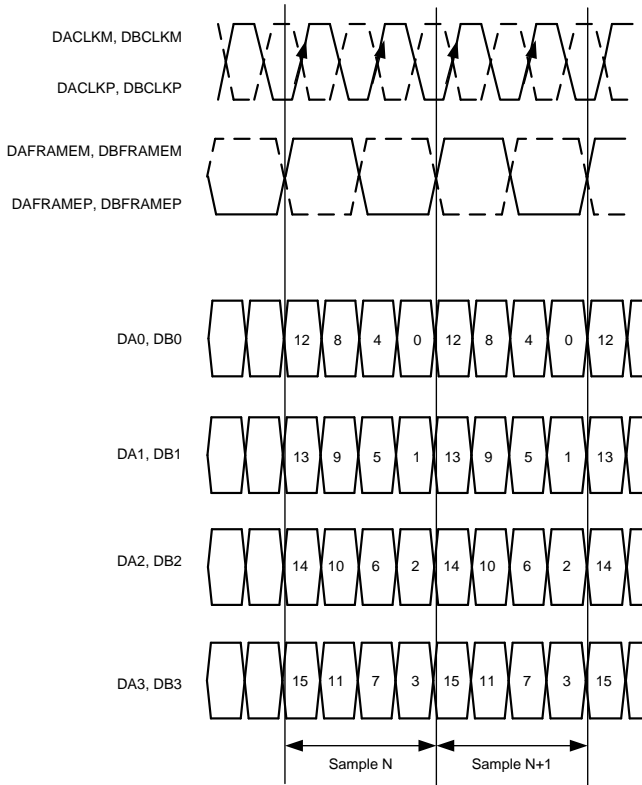

Figure 101. QDR LVDS Interface Timing: ADS42LB69

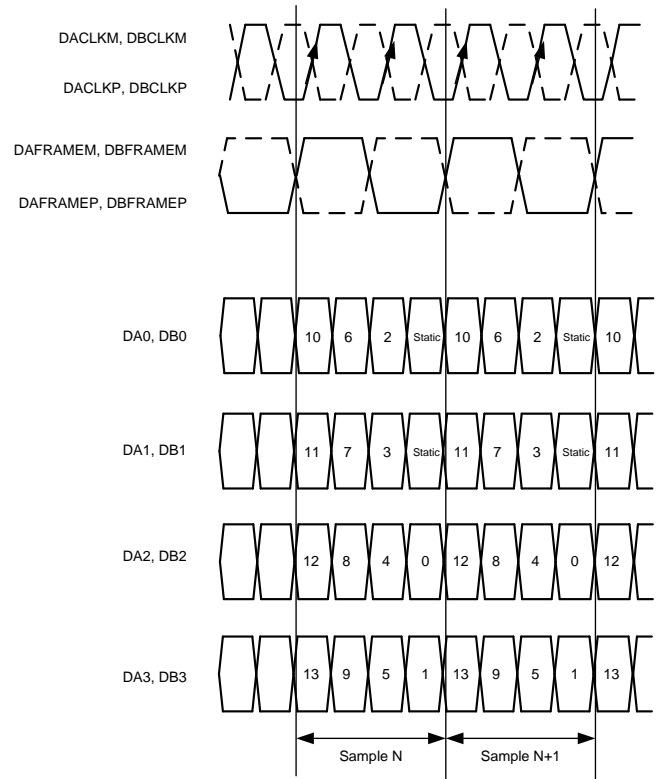
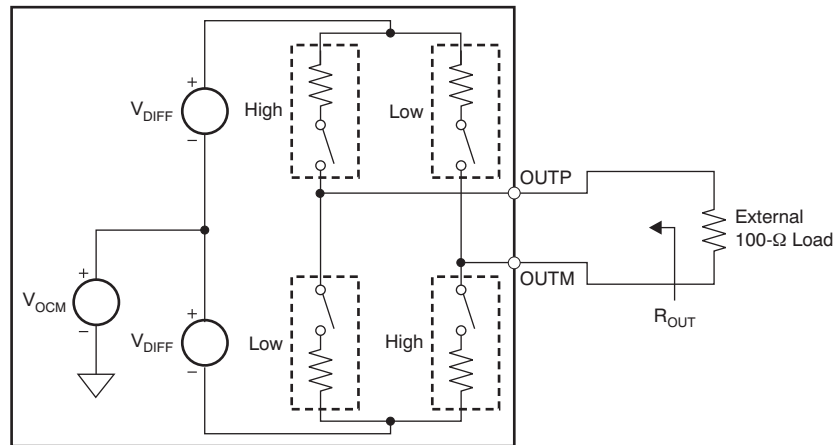

Figure 102. QDR LVDS Interface Timing: ADS42LB49

### LVDS Buffer

The equivalent circuit of each LVDS output buffer is shown in [Figure 103](#). After reset, the buffer presents an output impedance of 100  $\Omega$  to match with the external 100- $\Omega$  termination.



NOTE: Default swing across 100- $\Omega$  load is  $\pm 350$  mV. Use the LVDS SWING bits to change the swing.

**Figure 103. LVDS Buffer Equivalent Circuit**

The  $V_{DIFF}$  voltage is nominally 350 mV, resulting in an output swing of  $\pm 350$  mV with 100- $\Omega$  external termination. The  $V_{DIFF}$  voltage is programmable using the LVDS SWING register bits from  $\pm 125$  mV to  $\pm 570$  mV.

Additionally, a mode exists to double the strength of the LVDS buffer to support 50- $\Omega$  differential termination, as shown in [Figure 104](#). This mode can be used when the output LVDS signal is routed to two separate receiver chips, each using a 100- $\Omega$  termination. The mode can be enabled for LVDS output data (and for the frame clock in the QDR interface) buffers by setting the LVDS DATA STRENGTH register bit. For LVDS output clock buffers (applicable for both DDR and QDR interfaces), set both the LVDS CLKOUT STRENGTH EN and LVDS CLKOUT STRENGTH register bits to '1'.

The buffer output impedance behaves in the same way as a source-side series termination. Absorbing reflections from the receiver end helps improve signal integrity.

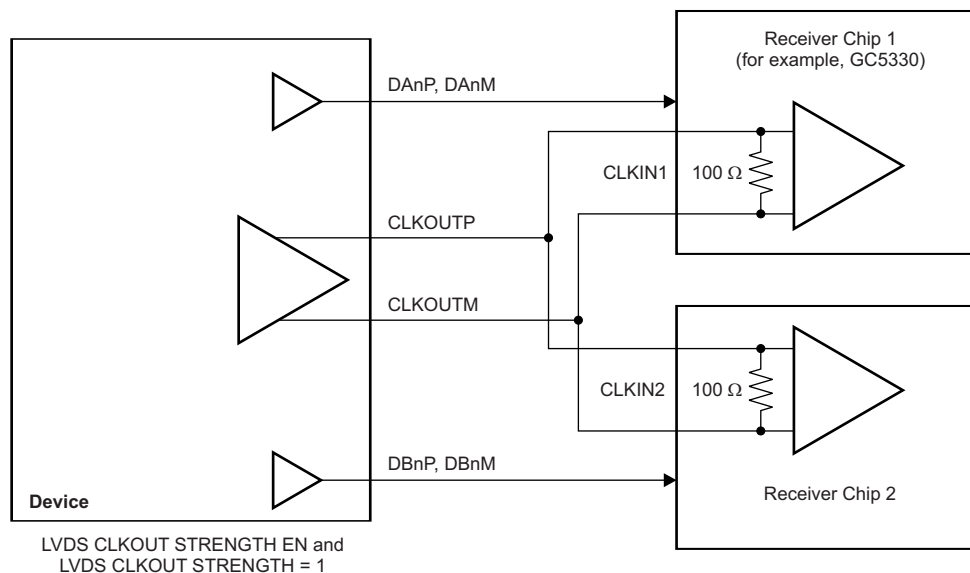

**Figure 104. LVDS Buffer Differential Termination**

## Output Data Format

Two output data formats are supported: twos complement and offset binary. The format can be selected using the DATA FORMAT serial interface register bit.

In the event of an input voltage overdrive, the digital outputs go to the appropriate full-scale level. For a positive overdrive, the output code is 3FFFh for the ADS42LB49 and ADS42LB69 in offset binary output format; the output code is 1FFFh for the ADS42LB49 and ADS42LB69 in twos complement output format. For a negative input overdrive, the output code is 0000h in offset binary output format and 2000h for the ADS42LB49 and ADS42LB69 in twos complement output format.

## REVISION HISTORY

NOTE: Page numbers for previous revisions may differ from page numbers in the current version.

<b>Changes from Revision C (September 2013) to Revision D</b>	<b>Page</b>
• Changed device status to Production Data .....	1
• Added pre-RTM changes throughout document .....	1
<hr/>	
<b>Changes from Revision B (March 2013) to Revision C</b>	<b>Page</b>
• Added pre-RTM changes throughout document .....	1
<hr/>	
<b>Changes from Revision A (November 2012) to Revision B</b>	<b>Page</b>
• Added pre-RTM changes throughout document .....	1
<hr/>	
<b>Changes from Original (October 2012) to Revision A</b>	<b>Page</b>
• Added pre-RTM changes throughout document .....	1

**PACKAGING INFORMATION**

Orderable Device	Status (1)	Package Type	Package Drawing	Pins	Package Qty	Eco Plan (2)	Lead/Ball Finish (6)	MSL Peak Temp (3)	Op Temp (°C)	Device Marking (4/5)	Samples
ADS42LB49IRGC25	ACTIVE	VQFN	RGC	64	25	Green (RoHS & no Sb/Br)	CU NIPDAU   Call TI	Level-3-260C-168 HR	-40 to 85	AZ42LB49	<a href="#">Samples</a>
ADS42LB49IRGCR	ACTIVE	VQFN	RGC	64	2000	Green (RoHS & no Sb/Br)	CU NIPDAU   Call TI	Level-3-260C-168 HR	-40 to 85	AZ42LB49	<a href="#">Samples</a>
ADS42LB49IRGCT	ACTIVE	VQFN	RGC	64	250	Green (RoHS & no Sb/Br)	CU NIPDAU   Call TI	Level-3-260C-168 HR	-40 to 85	AZ42LB49	<a href="#">Samples</a>
ADS42LB69IRGC25	ACTIVE	VQFN	RGC	64	25	Green (RoHS & no Sb/Br)	CU NIPDAU   Call TI	Level-3-260C-168 HR	-40 to 85	AZ42LB69	<a href="#">Samples</a>
ADS42LB69IRGCR	ACTIVE	VQFN	RGC	64	2000	Green (RoHS & no Sb/Br)	CU NIPDAU   Call TI	Level-3-260C-168 HR	-40 to 85	AZ42LB69	<a href="#">Samples</a>
ADS42LB69IRGCT	ACTIVE	VQFN	RGC	64	250	Green (RoHS & no Sb/Br)	CU NIPDAU   Call TI	Level-3-260C-168 HR	-40 to 85	AZ42LB69	<a href="#">Samples</a>

(1) The marketing status values are defined as follows:

**ACTIVE:** Product device recommended for new designs.

**LIFEBUY:** TI has announced that the device will be discontinued, and a lifetime-buy period is in effect.

**NRND:** Not recommended for new designs. Device is in production to support existing customers, but TI does not recommend using this part in a new design.

**PREVIEW:** Device has been announced but is not in production. Samples may or may not be available.

**OBSOLETE:** TI has discontinued the production of the device.

(2) Eco Plan - The planned eco-friendly classification: Pb-Free (RoHS), Pb-Free (RoHS Exempt), or Green (RoHS & no Sb/Br) - please check <http://www.ti.com/productcontent> for the latest availability information and additional product content details.

**TBD:** The Pb-Free/Green conversion plan has not been defined.

**Pb-Free (RoHS):** TI's terms "Lead-Free" or "Pb-Free" mean semiconductor products that are compatible with the current RoHS requirements for all 6 substances, including the requirement that lead not exceed 0.1% by weight in homogeneous materials. Where designed to be soldered at high temperatures, TI Pb-Free products are suitable for use in specified lead-free processes.

**Pb-Free (RoHS Exempt):** This component has a RoHS exemption for either 1) lead-based flip-chip solder bumps used between the die and package, or 2) lead-based die adhesive used between the die and leadframe. The component is otherwise considered Pb-Free (RoHS compatible) as defined above.

**Green (RoHS & no Sb/Br):** TI defines "Green" to mean Pb-Free (RoHS compatible), and free of Bromine (Br) and Antimony (Sb) based flame retardants (Br or Sb do not exceed 0.1% by weight in homogeneous material)

(3) MSL, Peak Temp. - The Moisture Sensitivity Level rating according to the JEDEC industry standard classifications, and peak solder temperature.

(4) There may be additional marking, which relates to the logo, the lot trace code information, or the environmental category on the device.

(5) Multiple Device Markings will be inside parentheses. Only one Device Marking contained in parentheses and separated by a "~" will appear on a device. If a line is indented then it is a continuation of the previous line and the two combined represent the entire Device Marking for that device.

<sup>(6)</sup> Lead/Ball Finish - Orderable Devices may have multiple material finish options. Finish options are separated by a vertical ruled line. Lead/Ball Finish values may wrap to two lines if the finish value exceeds the maximum column width.

**Important Information and Disclaimer:** The information provided on this page represents TI's knowledge and belief as of the date that it is provided. TI bases its knowledge and belief on information provided by third parties, and makes no representation or warranty as to the accuracy of such information. Efforts are underway to better integrate information from third parties. TI has taken and continues to take reasonable steps to provide representative and accurate information but may not have conducted destructive testing or chemical analysis on incoming materials and chemicals. TI and TI suppliers consider certain information to be proprietary, and thus CAS numbers and other limited information may not be available for release.

In no event shall TI's liability arising out of such information exceed the total purchase price of the TI part(s) at issue in this document sold by TI to Customer on an annual basis.

## TAPE AND REEL INFORMATION

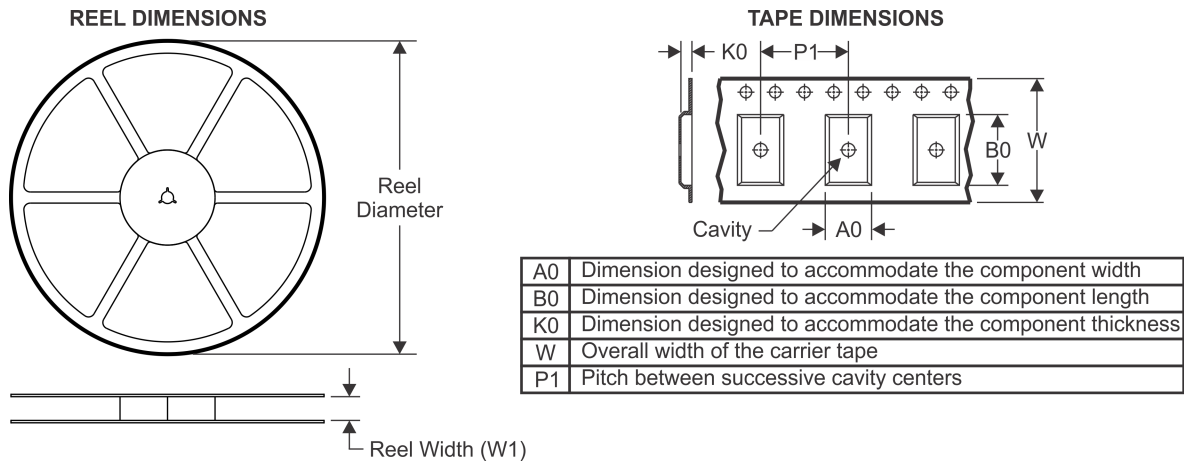

### QUADRANT ASSIGNMENTS FOR PIN 1 ORIENTATION IN TAPE

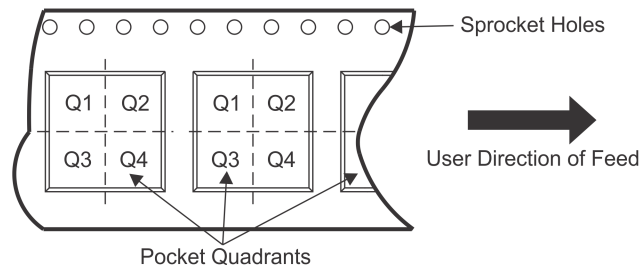

\*All dimensions are nominal

Device	Package Type	Package Drawing	Pins	SPQ	Reel Diameter (mm)	Reel Width W1 (mm)	A0 (mm)	B0 (mm)	K0 (mm)	P1 (mm)	W (mm)	Pin1 Quadrant
ADS42LB49IRGCR	VQFN	RGC	64	2000	330.0	16.4	9.3	9.3	1.5	12.0	16.0	Q2
ADS42LB49IRGCT	VQFN	RGC	64	250	330.0	16.4	9.3	9.3	1.5	12.0	16.0	Q2
ADS42LB69IRGCR	VQFN	RGC	64	2000	330.0	16.4	9.3	9.3	1.5	12.0	16.0	Q2
ADS42LB69IRGCT	VQFN	RGC	64	250	330.0	16.4	9.3	9.3	1.5	12.0	16.0	Q2

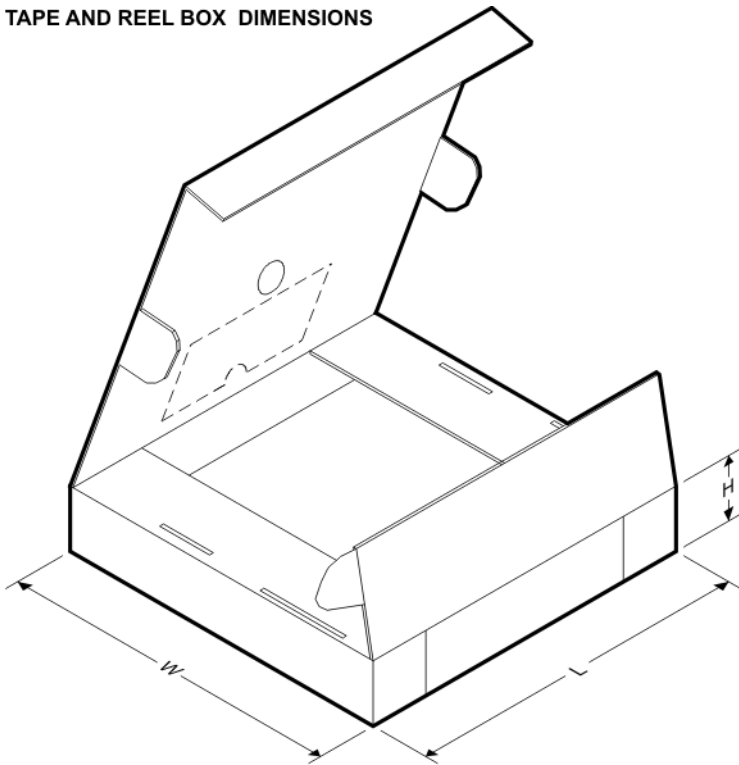
**TAPE AND REEL BOX DIMENSIONS**

\*All dimensions are nominal

Device	Package Type	Package Drawing	Pins	SPQ	Length (mm)	Width (mm)	Height (mm)
ADS42LB49IRGCR	VQFN	RGC	64	2000	336.6	336.6	28.6
ADS42LB49IRGCT	VQFN	RGC	64	250	336.6	336.6	28.6
ADS42LB69IRGCR	VQFN	RGC	64	2000	336.6	336.6	28.6
ADS42LB69IRGCT	VQFN	RGC	64	250	336.6	336.6	28.6

# MECHANICAL DATA

RGC(S-PVQFN-N64) CUSTOM DEVICE PLASTIC QUAD FLATPACK NO-LEAD

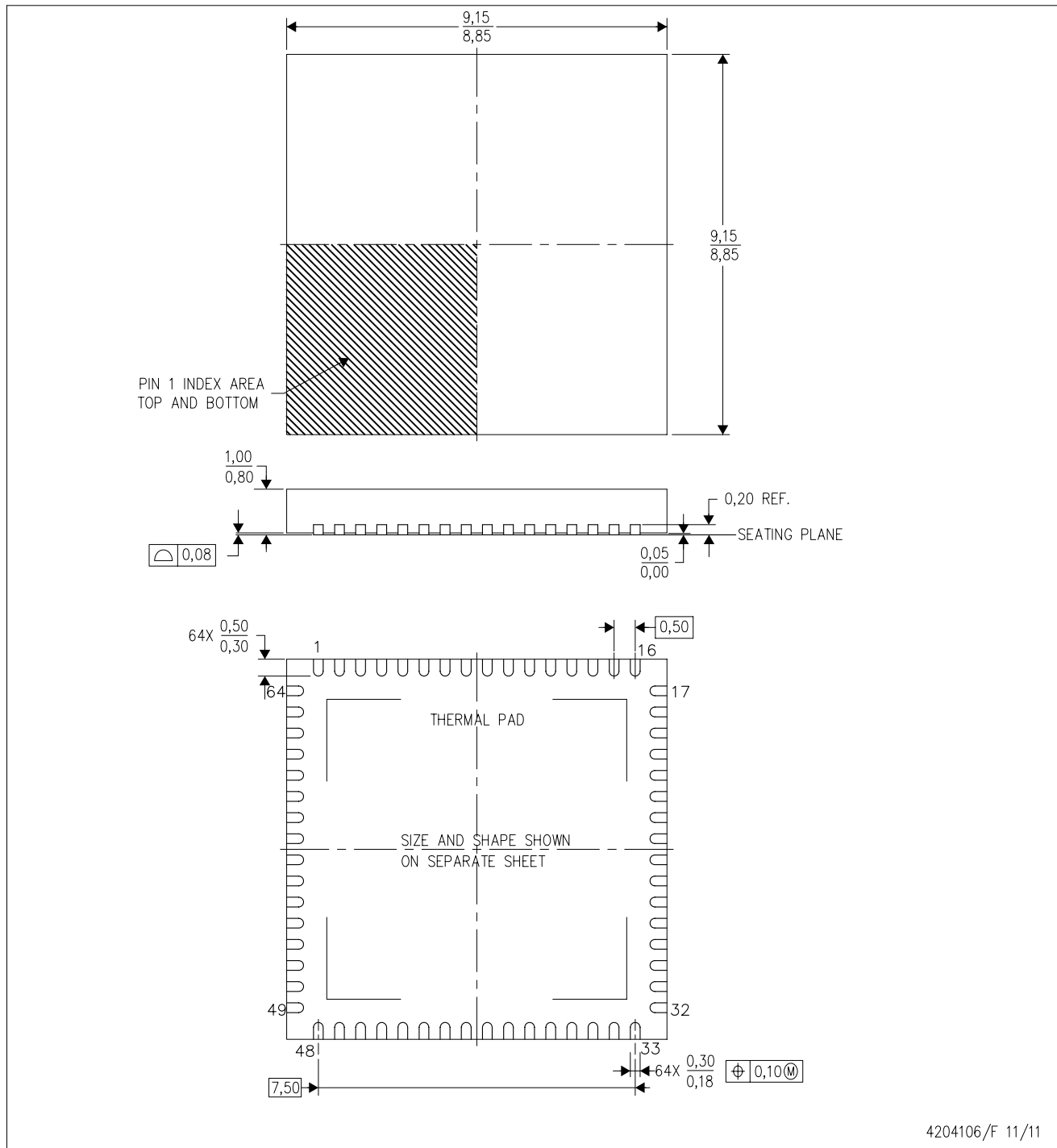

4204106/F 11/11

- NOTES:
- All linear dimensions are in millimeters. Dimensioning and tolerancing per ASME Y14.5-1994.
  - This drawing is subject to change without notice.
  - Quad Flatpack, No-leads (QFN) package configuration.
  - The package thermal pad must be soldered to the board for thermal and mechanical performance.
  - See the additional figure in the Product Data Sheet for details regarding the exposed thermal pad features and dimensions.

# THERMAL PAD MECHANICAL DATA

RGC (S-PVQFN-N64)

PLASTIC QUAD FLATPACK NO-LEAD

## THERMAL INFORMATION

This package incorporates an exposed thermal pad that is designed to be attached directly to an external heatsink. The thermal pad must be soldered directly to the printed circuit board (PCB). After soldering, the PCB can be used as a heatsink. In addition, through the use of thermal vias, the thermal pad can be attached directly to the appropriate copper plane shown in the electrical schematic for the device, or alternatively, can be attached to a special heatsink structure designed into the PCB. This design optimizes the heat transfer from the integrated circuit (IC).

For information on the Quad Flatpack No-Lead (QFN) package and its advantages, refer to Application Report, QFN/SON PCB Attachment, Texas Instruments Literature No. SLUA271. This document is available at [www.ti.com](http://www.ti.com).

The exposed thermal pad dimensions for this package are shown in the following illustration.

PIN 1 INDICATOR  
CO,35

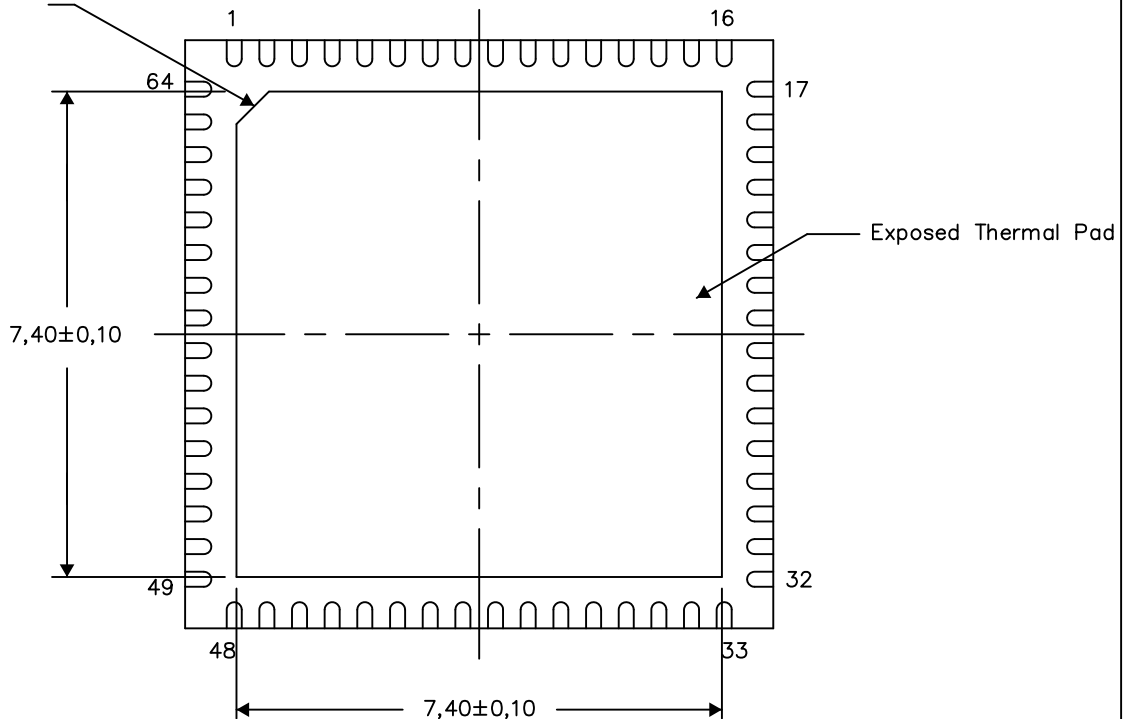

Bottom View

Exposed Thermal Pad Dimensions

4206192-4/AB 10/13

NOTE: A. All linear dimensions are in millimeters

RGC (S-PVQFN-N64)

PLASTIC QUAD FLATPACK NO-LEAD

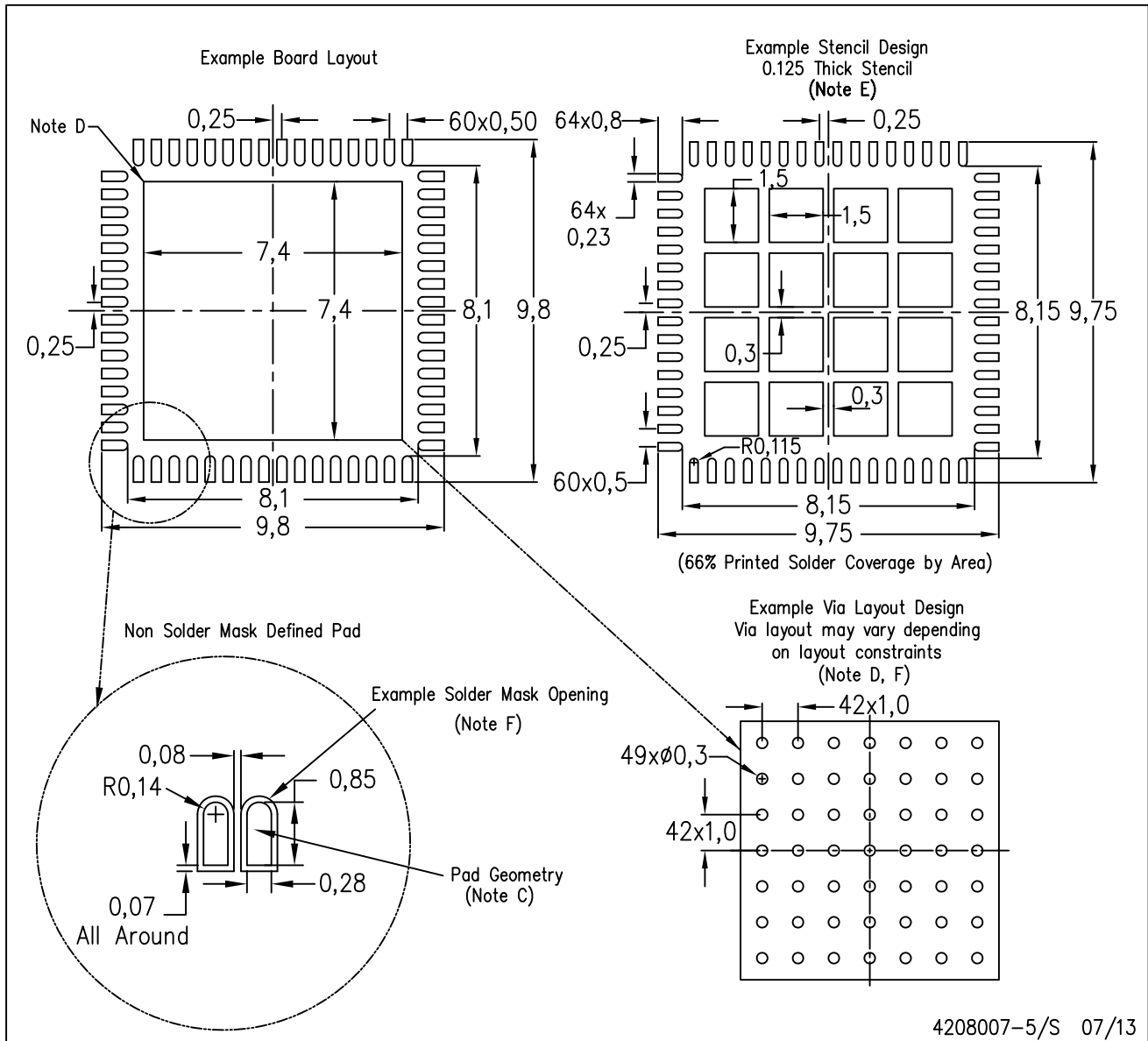

- NOTES:
- All linear dimensions are in millimeters.
  - This drawing is subject to change without notice.
  - Publication IPC-7351 is recommended for alternate designs.
  - This package is designed to be soldered to a thermal pad on the board. Refer to Application Note, Quad Flat-Pack Packages, Texas Instruments Literature No. SLUA271, and also the Product Data Sheets for specific thermal information, via requirements, and recommended board layout. These documents are available at [www.ti.com](http://www.ti.com) <<http://www.ti.com>>.
  - Laser cutting apertures with trapezoidal walls and also rounding corners will offer better paste release. Customers should contact their board assembly site for stencil design recommendations. Refer to IPC 7525 for stencil design considerations.
  - Customers should contact their board fabrication site for recommended solder mask tolerances and via tenting recommendations for vias placed in thermal pad.

## IMPORTANT NOTICE

Texas Instruments Incorporated and its subsidiaries (TI) reserve the right to make corrections, enhancements, improvements and other changes to its semiconductor products and services per JESD46, latest issue, and to discontinue any product or service per JESD48, latest issue. Buyers should obtain the latest relevant information before placing orders and should verify that such information is current and complete. All semiconductor products (also referred to herein as "components") are sold subject to TI's terms and conditions of sale supplied at the time of order acknowledgment.

TI warrants performance of its components to the specifications applicable at the time of sale, in accordance with the warranty in TI's terms and conditions of sale of semiconductor products. Testing and other quality control techniques are used to the extent TI deems necessary to support this warranty. Except where mandated by applicable law, testing of all parameters of each component is not necessarily performed.

TI assumes no liability for applications assistance or the design of Buyers' products. Buyers are responsible for their products and applications using TI components. To minimize the risks associated with Buyers' products and applications, Buyers should provide adequate design and operating safeguards.

TI does not warrant or represent that any license, either express or implied, is granted under any patent right, copyright, mask work right, or other intellectual property right relating to any combination, machine, or process in which TI components or services are used. Information published by TI regarding third-party products or services does not constitute a license to use such products or services or a warranty or endorsement thereof. Use of such information may require a license from a third party under the patents or other intellectual property of the third party, or a license from TI under the patents or other intellectual property of TI.

Reproduction of significant portions of TI information in TI data books or data sheets is permissible only if reproduction is without alteration and is accompanied by all associated warranties, conditions, limitations, and notices. TI is not responsible or liable for such altered documentation. Information of third parties may be subject to additional restrictions.

Resale of TI components or services with statements different from or beyond the parameters stated by TI for that component or service voids all express and any implied warranties for the associated TI component or service and is an unfair and deceptive business practice. TI is not responsible or liable for any such statements.

Buyer acknowledges and agrees that it is solely responsible for compliance with all legal, regulatory and safety-related requirements concerning its products, and any use of TI components in its applications, notwithstanding any applications-related information or support that may be provided by TI. Buyer represents and agrees that it has all the necessary expertise to create and implement safeguards which anticipate dangerous consequences of failures, monitor failures and their consequences, lessen the likelihood of failures that might cause harm and take appropriate remedial actions. Buyer will fully indemnify TI and its representatives against any damages arising out of the use of any TI components in safety-critical applications.

In some cases, TI components may be promoted specifically to facilitate safety-related applications. With such components, TI's goal is to help enable customers to design and create their own end-product solutions that meet applicable functional safety standards and requirements. Nonetheless, such components are subject to these terms.

No TI components are authorized for use in FDA Class III (or similar life-critical medical equipment) unless authorized officers of the parties have executed a special agreement specifically governing such use.

Only those TI components which TI has specifically designated as military grade or "enhanced plastic" are designed and intended for use in military/aerospace applications or environments. Buyer acknowledges and agrees that any military or aerospace use of TI components which have **not** been so designated is solely at the Buyer's risk, and that Buyer is solely responsible for compliance with all legal and regulatory requirements in connection with such use.

TI has specifically designated certain components as meeting ISO/TS16949 requirements, mainly for automotive use. In any case of use of non-designated products, TI will not be responsible for any failure to meet ISO/TS16949.

### Products

Audio	<a href="http://www.ti.com/audio">www.ti.com/audio</a>
Amplifiers	<a href="http://amplifier.ti.com">amplifier.ti.com</a>
Data Converters	<a href="http://dataconverter.ti.com">dataconverter.ti.com</a>
DLP® Products	<a href="http://www.dlp.com">www.dlp.com</a>
DSP	<a href="http://dsp.ti.com">dsp.ti.com</a>
Clocks and Timers	<a href="http://www.ti.com/clocks">www.ti.com/clocks</a>
Interface	<a href="http://interface.ti.com">interface.ti.com</a>
Logic	<a href="http://logic.ti.com">logic.ti.com</a>
Power Mgmt	<a href="http://power.ti.com">power.ti.com</a>
Microcontrollers	<a href="http://microcontroller.ti.com">microcontroller.ti.com</a>
RFID	<a href="http://www.ti-rfid.com">www.ti-rfid.com</a>
OMAP Applications Processors	<a href="http://www.ti.com/omap">www.ti.com/omap</a>
Wireless Connectivity	<a href="http://www.ti.com/wirelessconnectivity">www.ti.com/wirelessconnectivity</a>

### Applications

Automotive and Transportation	<a href="http://www.ti.com/automotive">www.ti.com/automotive</a>
Communications and Telecom	<a href="http://www.ti.com/communications">www.ti.com/communications</a>
Computers and Peripherals	<a href="http://www.ti.com/computers">www.ti.com/computers</a>
Consumer Electronics	<a href="http://www.ti.com/consumer-apps">www.ti.com/consumer-apps</a>
Energy and Lighting	<a href="http://www.ti.com/energy">www.ti.com/energy</a>
Industrial	<a href="http://www.ti.com/industrial">www.ti.com/industrial</a>
Medical	<a href="http://www.ti.com/medical">www.ti.com/medical</a>
Security	<a href="http://www.ti.com/security">www.ti.com/security</a>
Space, Avionics and Defense	<a href="http://www.ti.com/space-avionics-defense">www.ti.com/space-avionics-defense</a>
Video and Imaging	<a href="http://www.ti.com/video">www.ti.com/video</a>

### TI E2E Community

[e2e.ti.com](http://e2e.ti.com)