

AD1582/AD1583/AD1584/AD1585

FEATURES

Series Reference (2.5 V, 3 V, 4.096 V, 5 V)
 Low Quiescent Current: 70 μA max
 Current Output Capability: ± 5 mA
 Wide Supply Range: $V_{\text{IN}} = V_{\text{OUT}} + 200$ mV to 12 V
 Wideband Noise (10 Hz–10 kHz): 50 μV rms
 Specified Temperature Range: -40°C to $+125^{\circ}\text{C}$
 Compact, Surface-Mount, SOT-23 Package

AD158x Products, Three Electrical Grades

Electrical Grade	Initial Accuracy			Tempco (ppm/°C)
	AD1582	AD1583/AD1585	AD1584	
B	0.08%	0.10%	0.10%	50
C	0.16%	0.20%	0.20%	50
A	0.80%	1.00%	0.98%	100

GENERAL DESCRIPTION

The AD1582, AD1583, AD1584, and AD1585 are a family of low cost, low power, low dropout, precision band gap references. These designs are available as three-terminal (series) devices and are packaged in the compact SOT-23, 3-lead, surface-mount package. The versatility of these references makes them ideal for use in battery-powered 3 V or 5 V systems where there may be wide variations in supply voltage and a need to minimize power dissipation.

The superior accuracy and temperature stability of the AD1582/AD1583/AD1584/AD1585 is made possible by the precise matching and thermal tracking of on-chip components. Patented temperature drift curvature correction design techniques minimize the nonlinearities in the voltage output temperature characteristic.

These series mode devices (AD1582/AD1583/AD1584/AD1585) source or sink up to 5 mA of load current and operate efficiently with only 200 mV of required headroom supply. This family draws a maximum 70 μA of quiescent current with only a 1.0 $\mu\text{A}/\text{V}$ variation with supply voltage. The advantage of these designs over conventional shunt devices is extraordinary. Valuable supply current is no longer wasted through an input series resistor and maximum power efficiency is achieved at all input voltage levels.

The AD1582, AD1583, AD1584, and AD1585 are available in three grades, A, B, and C, which are provided in a tiny footprint, the SOT-23. All grades are specified over the industrial temperature range of -40°C to $+125^{\circ}\text{C}$.

REV. C

Information furnished by Analog Devices is believed to be accurate and reliable. However, no responsibility is assumed by Analog Devices for its use, nor for any infringements of patents or other rights of third parties that may result from its use. No license is granted by implication or otherwise under any patent or patent rights of Analog Devices.

FUNCTIONAL BLOCK DIAGRAM

3-Lead SOT-23
(RT Suffix)

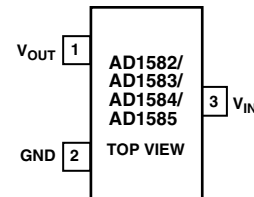

TARGET APPLICATIONS

1. Portable, battery-powered equipment. Notebook computers, cellular phones, pagers, PDAs, GPSs, and DMMs.
2. Computer workstations. Suitable for use with a wide range of video RAMDACs.
3. Smart industrial transmitters
4. PCMCIA cards
5. Automotive
6. Hard disk drives
7. 3 V/5 V 8-bit/12-bit data converters

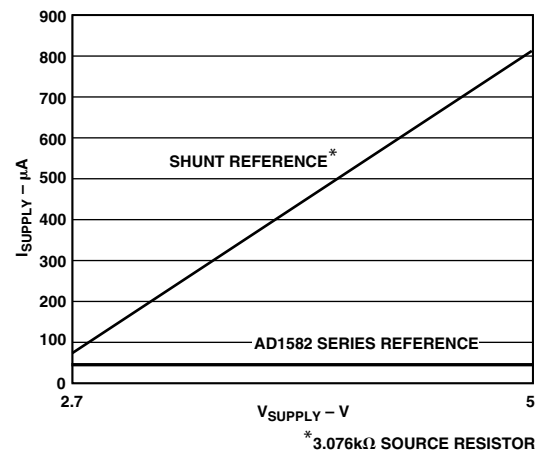

Figure 1. Supply Current (μA) vs. Supply Voltage (V)

AD1582/AD1583/AD1584/AD1585

AD1582—SPECIFICATIONS

(@ $T_A = T_{MIN}$ to T_{MAX} , $V_{IN} = 5$ V, unless otherwise noted.)

Parameter	AD1582A			AD1582B			AD1582C			Unit
	Min	Typ	Max	Min	Typ	Max	Min	Typ	Max	
OUTPUT VOLTAGE (@ 25°C) V_O	2.480	2.500	2.520	2.498	2.500	2.502	2.496	2.500	2.504	V
INITIAL ACCURACY ERROR (@ 25°C) V_{OERR}	-20 -0.80		+20 +0.80	-2 -0.08		+2 +0.08	-4 -0.16		+4 +0.16	mV %
OUTPUT VOLTAGE TEMPERATURE DRIFT			100			50			50	ppm/°C
TEMPERATURE COEFFICIENT (TCV _O) -40°C < T_A < +125°C 0°C < T_A < 70°C		40 35	100		18 15	50		18 15	50	ppm/°C ppm/°C
MINIMUM SUPPLY HEADROOM ($V_{IN}-V_{OUT}$)	200			200			200			mV
LOAD REGULATION 0 mA < I_{OUT} < 5 mA (-40°C to +85°C) 0 mA < I_{OUT} < 5 mA (-40°C to +125°C) -5 mA < I_{OUT} < 0 mA (-40°C to +85°C) -5 mA < I_{OUT} < 0 mA (-40°C to +125°C) -0.1 mA < I_{OUT} < +0.1 mA (-40°C to +85°C) -0.1 mA < I_{OUT} < +0.1 mA (-40°C to +125°C)			0.2 0.4 0.25 0.45 2.7 3.5			0.2 0.4 0.25 0.45 2.7 3.5			0.2 0.4 0.25 0.45 2.7 3.5	mV/mA mV/mA mV/mA mV/mA mV/mA mV/mA
LINE REGULATION V_{OUT} 200 mV < V_{IN} < 12 V $I_{OUT} = 0$ mA			25			25			25	μV/V
RIPPLE REJECTION ($\Delta V_{OUT}/\Delta V_{IN}$) $V_{IN} = 5$ V ± 100 mV (f = 120 Hz)	80			80			80			dB
QUIESCENT CURRENT			70			70			70	μA
SHORT CIRCUIT CURRENT TO GROUND			15			15			15	mA
NOISE VOLTAGE (@ 25°C) 0.1 Hz to 10 Hz 10 Hz to 10 kHz		70 50			70 50			70 50		μV p-p μV rms
TURN-ON SETTLING TIME TO 0.1%, $C_L = 0.2$ μF			100			100			100	μs
LONG-TERM STABILITY 1000 Hours @ 25°C		100			100			100		ppm/1000 hrs.
OUTPUT VOLTAGE HYSTERESIS		115			115			115		ppm
TEMPERATURE RANGE Specified Performance (A, B, C) Operating Performance (A, B, C)	-40 -55		+125 +125	-40 -55		+125 +125	-40 -55		+125 +125	°C °C

Specifications subject to change without notice.

AD1583—SPECIFICATIONS

(@ $T_A = T_{MIN}$ to T_{MAX} , $V_{IN} = 5$ V, unless otherwise noted.)

Parameter	AD1583A			AD1583B			AD1583C			Unit
	Min	Typ	Max	Min	Typ	Max	Min	Typ	Max	
OUTPUT VOLTAGE (@ 25°C) V_O	2.970	3.000	3.030	2.997	3.000	3.003	2.994	3.000	3.006	V
INITIAL ACCURACY ERROR (@ 25°C) V_{OERR}	-30 -1.0		+30 +1.0	-3 -0.1		+3 +0.1	-6 -0.20		+6 +0.20	mV %
OUTPUT VOLTAGE TEMPERATURE DRIFT			100			50			50	ppm/°C
TEMPERATURE COEFFICIENT (TCV _O) -40°C < T _A < +125°C 0°C < T _A < 70°C		40 35	100		18 15	50		18 15	50	ppm/°C ppm/°C
MINIMUM SUPPLY HEADROOM ($V_{IN}-V_{OUT}$)	200			200			200			mV
LOAD REGULATION 0 mA < I _{OUT} < 5 mA (-40°C to +85°C) 0 mA < I _{OUT} < 5 mA (-40°C to +125°C) -5 mA < I _{OUT} < 0 mA (-40°C to +85°C) -5 mA < I _{OUT} < 0 mA (-40°C to +125°C) -0.1 mA < I _{OUT} < +0.1 mA (-40°C to +85°C) -0.1 mA < I _{OUT} < +0.1 mA (-40°C to +125°C)			0.25 0.45 0.40 0.6 2.9 3.7			0.25 0.45 0.40 0.6 2.9 3.7			0.25 0.45 0.40 0.6 2.9 3.7	mV/mA mV/mA mV/mA mV/mA mV/mA mV/mA
LINE REGULATION V_{OUT} 200 mV < V_{IN} < 12 V I _{OUT} = 0 mA			25			25			25	μV/V
RIPPLE REJECTION ($\Delta V_{OUT}/\Delta V_{IN}$) $V_{IN} = 5$ V ± 100 mV (f = 120 Hz)	80			80			80			dB
QUIESCENT CURRENT			70			70			70	μA
SHORT CIRCUIT CURRENT TO GROUND			15			15			15	mA
NOISE VOLTAGE (@ 25°C) 0.1 Hz to 10 Hz 10 Hz to 10 kHz		85 60			85 60			85 60		μV p-p μV rms
TURN-ON SETTTLING TIME TO 0.1% C _L = 0.2 μF			120			120			120	μs
LONG-TERM STABILITY 1000 Hours @ 25°C		100			100			100		ppm/1000 hrs.
OUTPUT VOLTAGE HYSTERESIS		115			115			115		ppm
TEMPERATURE RANGE Specified Performance (A, B, C) Operating Performance (A, B, C)	-40 -55		+125 +125	-40 -55		+125 +125	-40 -55		+125 +125	°C °C

Specifications subject to change without notice.

AD1582/AD1583/AD1584/AD1585

AD1584—SPECIFICATIONS (@ $T_A = T_{MIN}$ to T_{MAX} , $V_{IN} = 5$ V, unless otherwise noted.)

Parameter	AD1584A			AD1584B			AD1584C			Unit
	Min	Typ	Max	Min	Typ	Max	Min	Typ	Max	
OUTPUT VOLTAGE (@ 25°C) V_O	4.056	4.096	4.136	4.092	4.096	4.100	4.088	4.096	4.104	V
INITIAL ACCURACY ERROR (@ 25°C) V_{OERR}	-40 -0.98		+40 +0.98	-4 -0.1		+4 +0.1	-8 -0.2		+8 +0.2	mV %
OUTPUT VOLTAGE TEMPERATURE DRIFT			100			50			50	ppm/°C
TEMPERATURE COEFFICIENT (TCV _O) -40°C < T _A < +125°C 0°C < T _A < 70°C		40 35	100		18 15	50		18 15	50	ppm/°C ppm/°C
MINIMUM SUPPLY HEADROOM ($V_{IN}-V_{OUT}$)	200			200			200			mV
LOAD REGULATION 0 mA < I _{OUT} < 5 mA (-40°C to +85°C) 0 mA < I _{OUT} < 5 mA (-40°C to +125°C) -5 mA < I _{OUT} < 0 mA (-40°C to +85°C) -5 mA < I _{OUT} < 0 mA (-40°C to +125°C) -0.1 mA < I _{OUT} < +0.1 mA (-40°C to +85°C) -0.1 mA < I _{OUT} < +0.1 mA (-40°C to +125°C)			0.32 0.52 0.40 0.6 3.2 4.1			0.32 0.52 0.40 0.6 3.2 4.1			0.32 0.52 0.40 0.6 3.2 4.1	mV/mA mV/mA mV/mA mV/mA mV/mA mV/mA
LINE REGULATION $V_{OUT} 200$ mV < V_{IN} < 12 V I _{OUT} = 0 mA			25			25			25	μV/V
RIPPLE REJECTION ($\Delta V_{OUT}/\Delta V_{IN}$) $V_{IN} = 5$ V ± 100 mV (f = 120 Hz) ²	80			80			80			dB
QUIESCENT CURRENT			70			70			70	μA
SHORT CIRCUIT CURRENT TO GROUND			15			15			15	mA
NOISE VOLTAGE (@ 25°C) 0.1 Hz to 10 Hz 10 Hz to 10 kHz		110 90			110 90			110 90		μV p-p μV rms
TURN-ON SETTLING TIME TO 0.1% C _L = 0.2 μF			140			140			140	μs
LONG-TERM STABILITY 1000 Hours @ 25°C		100			100			100		ppm/1000 hrs.
OUTPUT VOLTAGE HYSTERESIS		115			115			115		ppm
TEMPERATURE RANGE Specified Performance (A, B, C) Operating Performance (A, B, C)	-40 -55		+125 +125	-40 -55		+125 +125	-40 -55		+125 +125	°C °C

Specifications subject to change without notice.

AD1585—SPECIFICATIONS

(@ $T_A = T_{MIN}$ to T_{MAX} , $V_{IN} = 6$ V, unless otherwise noted.)

Parameter	AD1585A			AD1585B			AD1585C			Unit
	Min	Typ	Max	Min	Typ	Max	Min	Typ	Max	
OUTPUT VOLTAGE (@ 25°C) V_O	4.950	5.000	5.050	4.995	5.000	5.005	4.990	5.000	5.010	V
INITIAL ACCURACY ERROR (@ 25°C) V_{OERR}	-50 -1.0		+50 +1.0	-5 -0.10		+5 +0.10	-10 -0.20		+10 +0.20	mV %
OUTPUT VOLTAGE TEMPERATURE DRIFT			100			50			50	ppm/°C
TEMPERATURE COEFFICIENT (TCV _O) -40°C < T _A < +125°C 0°C < T _A < 70°C		40 35	100		18 15	50		18 15	50	ppm/°C ppm/°C
MINIMUM SUPPLY HEADROOM ($V_{IN}-V_{OUT}$)	200			200			200			mV
LOAD REGULATION 0 mA < I _{OUT} < 5 mA (-40°C to +85°C) 0 mA < I _{OUT} < 5 mA (-40°C to +125°C) -5 mA < I _{OUT} < 0 mA (-40°C to +85°C) -5 mA < I _{OUT} < 0 mA (-40°C to +125°C) -0.1 mA < I _{OUT} < +0.1 mA (-40°C to +85°C) -0.1 mA < I _{OUT} < +0.1 mA (-40°C to +125°C)			0.40 0.6 0.40 0.6 4 4.8			0.40 0.6 0.40 0.6 4 4.8			0.40 0.6 0.40 0.6 4 4.8	mV/mA mV/mA mV/mA mV/mA mV/mA mV/mA
LINE REGULATION $V_{OUT} 200$ mV < $V_{IN} < 12$ V I _{OUT} = 0 mA			25			25			25	μV/V
RIPPLE REJECTION ($\Delta V_{OUT}/\Delta V_{IN}$) $V_{IN} = 6$ V ± 100 mV (f = 120 Hz)	80			80			80			dB
QUIESCENT CURRENT			70			70			70	μA
SHORT CIRCUIT CURRENT TO GROUND			15			15			15	mA
NOISE VOLTAGE (@ 25°C) 0.1 Hz to 10 Hz 10 Hz to 10 kHz		140 100			140 100			140 100		μV p-p μV rms
TURN-ON SETTLING TIME TO 0.1% C _L = 0.2 μF			175			175			175	μs
LONG-TERM STABILITY 1000 Hours @ 25°C		100			100			100		ppm/1000 hrs.
OUTPUT VOLTAGE HYSTERESIS		115			115			115		ppm
TEMPERATURE RANGE Specified Performance (A, B, C) Operating Performance (A, B, C)	-40 -55		+125 +125	-40 -55		+125 +125	-40 -55		+125 +125	°C °C

Specifications subject to change without notice.

AD1582/AD1583/AD1584/AD1585

ABSOLUTE MAXIMUM RATINGS¹

V_{IN} to Ground	12 V
Internal Power Dissipation ²	
SOT-23 (RT)	400 mW
Storage Temperature Range	-65°C to +125°C
Specified Temperature Range	
AD1582RT/AD1583RT/	
AD1584RT/AD1585RT	-40°C to +125°C
Lead Temperature, Soldering	
Vapor Phase (60 sec)	215°C
Infrared (15 sec)	220°C

NOTES

¹Stresses above those listed under Absolute Maximum Ratings may cause permanent damage to the device. This is a stress rating only; functional operation of the device at these or any other conditions above those indicated in the operational section of this specification is not implied. Exposure to absolute maximum rating conditions for extended periods may affect device reliability.

²Specification is for device in free air at 25°C: SOT-23 package: $\theta_{JA} = 300^{\circ}\text{C}/\text{W}$.

CAUTION

ESD (electrostatic discharge) sensitive device. Electrostatic charges as high as 4000 V readily accumulate on the human body and test equipment and can discharge without detection. Although the AD1582/AD1583/AD1584/AD1585 feature proprietary ESD protection circuitry, permanent damage may occur on devices subjected to high energy electrostatic discharges. Therefore, proper ESD precautions are recommended to avoid performance degradation or loss of functionality.



PACKAGE BRANDING INFORMATION

Four fields identify the device:

- First field, product identifier, for example, a “2/3/4/5” identifies the generic as AD1582/AD1583/AD1584/AD1585
- Second field, device grade, which can be “A,” “B,” or “C”
- Third field, calendar year of processing, “7” for 1997..., “A” for 2001...
- Fourth field, two week window within the calendar year, for example, letters A–Z to represent a two-week window starting with “A” for the first two weeks of January.

ORDERING GUIDE

Model	Output Voltage	Accuracy (mV)	Initial Accuracy %	Initial Temperature Coefficient	Package Description	Package Option	Top Mark	Number of Parts per Reel
AD1582ART-Reel	2.50	20	0.80%	100	SOT-23	RT-3	2A0A	10,000
AD1582ART-Reel7	2.50	20	0.80%	100	SOT-23	RT-3	2A0A	3,000
AD1582BRT-Reel	2.50	2	0.08%	50	SOT-23	RT-3	2B0A	10,000
AD1582BRT-Reel7	2.50	2	0.08%	50	SOT-23	RT-3	2B0A	3,000
AD1582CRT-Reel	2.50	4	0.16%	50	SOT-23	RT-3	2C0A	10,000
AD1582CRT-Reel7	2.50	4	0.16%	50	SOT-23	RT-3	2C0A	3,000
AD1583ART-Reel	3.00	30	1.00%	100	SOT-23	RT-3	3A0A	10,000
AD1583ART-Reel7	3.00	30	1.00%	100	SOT-23	RT-3	3A0A	3,000
AD1583BRT-Reel	3.00	3	0.10%	50	SOT-23	RT-3	3B0A	10,000
AD1583BRT-Reel7	3.00	3	0.10%	50	SOT-23	RT-3	3B0A	3,000
AD1583CRT-Reel	3.00	6	0.20%	50	SOT-23	RT-3	3C0A	10,000
AD1583CRT-Reel7	3.00	6	0.20%	50	SOT-23	RT-3	3C0A	3,000
AD1584ART-Reel	4.096	40	0.98%	100	SOT-23	RT-3	4A0A	10,000
AD1584ART-Reel7	4.096	40	0.98%	100	SOT-23	RT-3	4A0A	3,000
AD1584BRT-Reel	4.096	4	0.10%	50	SOT-23	RT-3	4B0A	10,000
AD1584BRT-Reel7	4.096	4	0.10%	50	SOT-23	RT-3	4B0A	3,000
AD1584CRT-Reel	4.096	8	0.20%	50	SOT-23	RT-3	4C0A	10,000
AD1584CRT-Reel7	4.096	8	0.20%	50	SOT-23	RT-3	4C0A	3,000
AD1585ART-Reel	5.00	50	1.00%	100	SOT-23	RT-3	5A0A	10,000
AD1585ART-Reel7	5.00	50	1.00%	100	SOT-23	RT-3	5A0A	3,000
AD1585BRT-Reel	5.00	5	0.10%	50	SOT-23	RT-3	5B0A	10,000
AD1585BRT-Reel7	5.00	5	0.10%	50	SOT-23	RT-3	5B0A	3,000
AD1585CRT-Reel	5.00	10	0.20%	50	SOT-23	RT-3	5C0A	10,000
AD1585CRT-Reel7	5.00	10	0.20%	50	SOT-23	RT-3	5C0A	3,000

PARAMETER DEFINITION

Temperature Coefficient (TCV_O)

The change of output voltage over the operating temperature change and normalized by the output voltage at 25°C, expressed in ppm/°C. The equation follows:

$$TCV_O [ppm/°C] = \frac{V_O(T_2) - V_O(T_1)}{V_O(25°C) \times (T_2 - T_1)} \times 10^6$$

Where:

$$V_O(25°C) = V_O \text{ at } 25°C$$

$$V_O(T_1) = V_O \text{ at temperature1}$$

$$V_O(T_2) = V_O \text{ at temperature2}$$

Line Regulation (ΔV_O/ΔV_{IN})

The change in output voltage due to a specified change in input voltage. It includes the effects of self-heating. Line regulation is expressed in either percent per volt, parts-per-million per volt, or microvolts per volt change in input voltage.

Load Regulation (ΔV_O/ΔI_{LOAD})

The change in output voltage due to a specified change in load current. It includes the effects of self-heating. Load Regulation is expressed in either microvolts per milliampere, parts-per-million per milliampere, or Ω of dc output resistance.

Long-Term Stability (ΔV_O)

Typical shift of output voltage at 25°C on a sample of parts subjected to an operation life test of 1000 hours at 125°C:

$$\Delta V_O = V_O(t_0) - V_O(t_1)$$

$$\Delta V_O [ppm] = \frac{V_O(t_0) - V_O(t_1)}{V_O(t_0)} \times 10^6$$

Where:

$$V_O(t_0) = V_O \text{ at } 25°C \text{ at time } 0$$

$$V_O(t_1) = V_O \text{ at } 25°C \text{ after } 1000 \text{ hours operation at } 125°C$$

Thermal Hysteresis (V_{O_HYS})

The change of output voltage after the device is cycled through temperatures from +25°C to -40°C to +85°C and back to +25°C. This is a typical value from a sample of parts put through such a cycle:

$$V_{O_HYS} = V_O(25°C) - V_{O_TC}$$

$$V_{O_HYS} [ppm] = \frac{V_O(25°C) - V_{O_TC}}{V_O(25°C)} \times 10^6$$

Where:

$$V_O(25°C) = V_O \text{ at } 25°C$$

$$V_{O_TC} = V_O \text{ at } 25°C \text{ after temperature cycle at } +25°C \text{ to } -40°C \text{ to } +85°C \text{ and back to } +25°C$$

Operating Temperature

The temperature extremes at which the device can still function. Parts may deviate from their specified performance outside the specified temperature range.

AD1582/AD1583/AD1584/AD1585—Typical Performance Characteristics

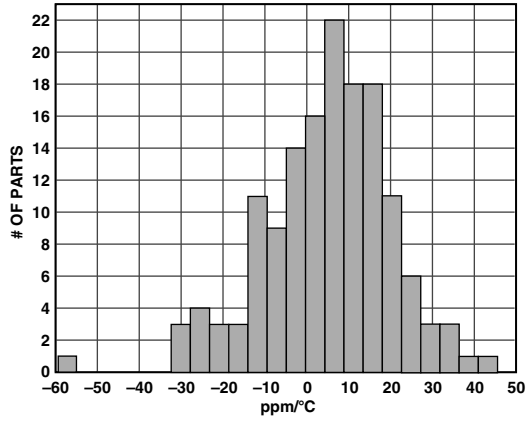

TPC 1. Typical Output Voltage Temperature Drift Distribution

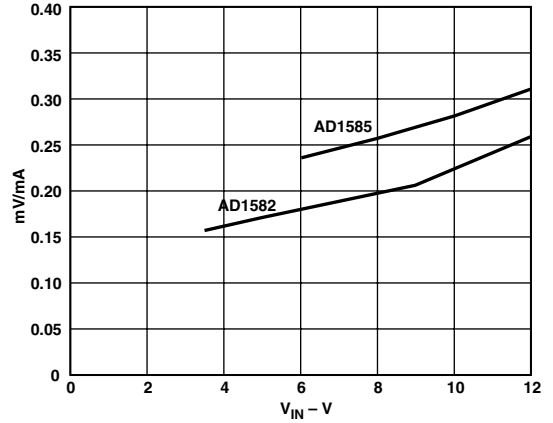

TPC 4. Load Regulation vs. V_{IN}

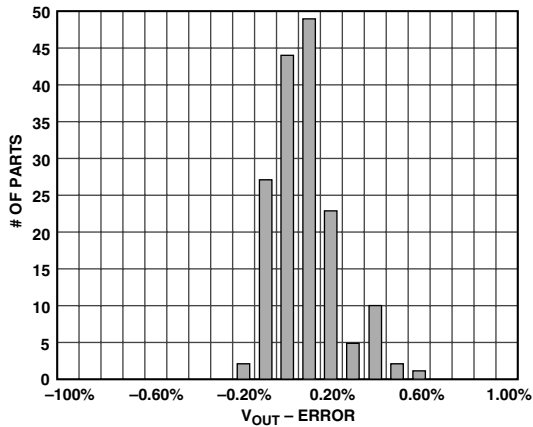

TPC 2. Typical Output Voltage Error Distribution

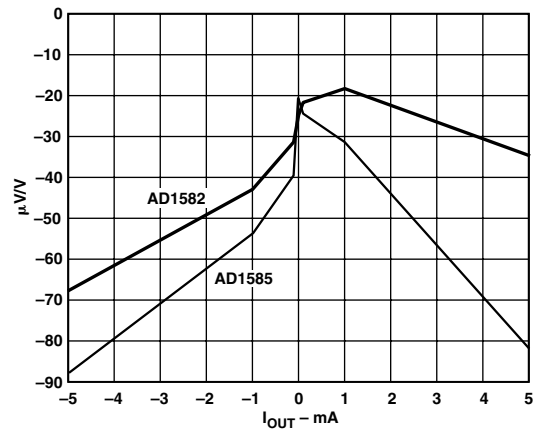

TPC 5. Line Regulation vs. I_{LOAD}

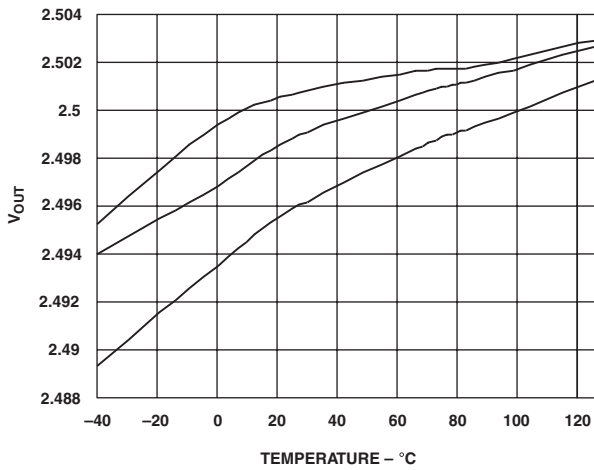

TPC 3. Typical Temperature Drift Characteristic Curves

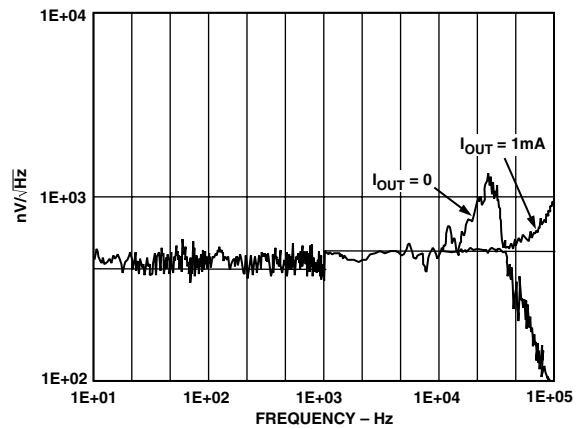

TPC 6. Noise Spectral Density

THEORY OF OPERATION

The AD1582/AD1583/AD1584/AD1585 family uses the band gap concept to produce stable, low temperature coefficient voltage references suitable for high accuracy data acquisition components and systems. This family of precision references uses the underlying temperature characteristics of a silicon transistor's base-emitter voltage in the forward-biased operating region. Under this condition, all such transistors have a $-2 \text{ mV}/^\circ\text{C}$ temperature coefficient (TC) and a V_{BE} that, when extrapolated to absolute zero, 0°K , (with collector current proportional to absolute temperature) approximates the silicon band gap voltage. By summing a voltage that has an equal and opposite temperature coefficient of $2 \text{ mV}/^\circ\text{C}$ with the V_{BE} of a forward-biased transistor, an almost zero TC reference can be developed. In the AD1582/AD1583/AD1584/AD1585 simplified circuit diagram shown in Figure 2, such a compensating voltage, V_1 , is derived by driving two transistors at different current densities and amplifying the resultant V_{BE} difference (ΔV_{BE} —which has a positive TC). The sum of V_{BE} and $V_1(V_{BG})$ is then buffered and amplified to produce stable reference voltage outputs of 2.5 V, 3 V, 4.096 V, and 5 V.

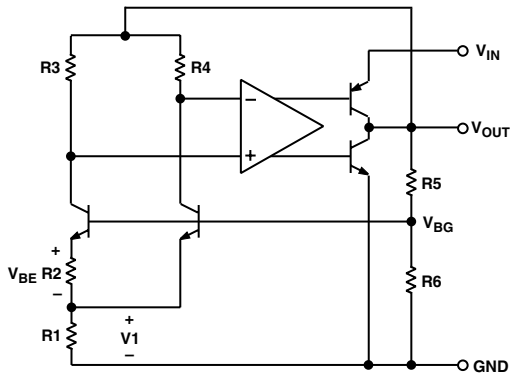

Figure 2. Simplified Schematic

APPLYING THE AD1582/AD1583/AD1584/AD1585

The AD1582/AD1583/AD1584/AD1585 is a family of series references that can be used for many applications. To achieve optimum performance with these references, only two external components are required. Figure 3 shows the AD1582 configured for operation under all loading conditions. With a simple $4.7 \mu\text{F}$ capacitor attached to the input and a $1 \mu\text{F}$ capacitor applied to the output, the devices can achieve specified performance for all input voltage and output current requirements. For best transient response, add a $0.1 \mu\text{F}$ capacitor in parallel with the $4.7 \mu\text{F}$ capacitor. While a $1 \mu\text{F}$ output capacitor can provide stable performance for all loading conditions, the AD1582 can operate under low ($-100 \mu\text{A} < I_{OUT} < +100 \mu\text{A}$) current conditions with just a $0.2 \mu\text{F}$ output capacitor. The $4.7 \mu\text{F}$ capacitor on the input can be reduced to $1 \mu\text{F}$ in this condition.

Unlike conventional shunt reference designs, the AD1582/AD1583/AD1584/AD1585 family provides stable output voltages at constant operating current levels. When properly decoupled, as shown in Figure 3, these devices can be applied to any circuit and provide superior low power solutions.

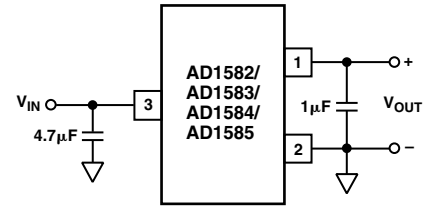

Figure 3. Typical Connection Diagram

TEMPERATURE PERFORMANCE

The AD1582/AD1583/AD1584/AD1585 family of references is designed for applications where temperature performance is important. Extensive temperature testing and characterization ensures that the device's performance is maintained over the specified temperature range.

The error band guaranteed with the AD1582/AD1583/AD1584/AD1585 family is the maximum deviation from the initial value at 25°C . Thus, for a given grade of the AD1582/AD1583/AD1584/AD1585, the designer can easily determine the maximum total error by summing initial accuracy and temperature variation, e.g., for the AD1582BRT, the initial tolerance is $\pm 2 \text{ mV}$, the temperature error band is $\pm 8 \text{ mV}$, thus the reference is guaranteed to be $2.5 \text{ V} \pm 10 \text{ mV}$ from -40°C to $+125^\circ\text{C}$.

Figure 4 shows the typical output voltage drift for the AD1582 and illustrates the methodology. The box in Figure 4 is bounded on the x-axis by operating temperature extremes. It is bounded on the y-axis by the maximum and minimum output voltages observed over the operating temperature range. The slope of the diagonal drawn from the initial output value at 25°C to the output values at $+125^\circ\text{C}$ and -40°C determines the performance grade of the device.

Duplication of these results requires a test system that is highly accurate with stable temperature control. Evaluation of the AD1582 produces curves similar to those in TPC 3 and Figure 4, but output readings may vary depending upon the test methods and test equipment used.

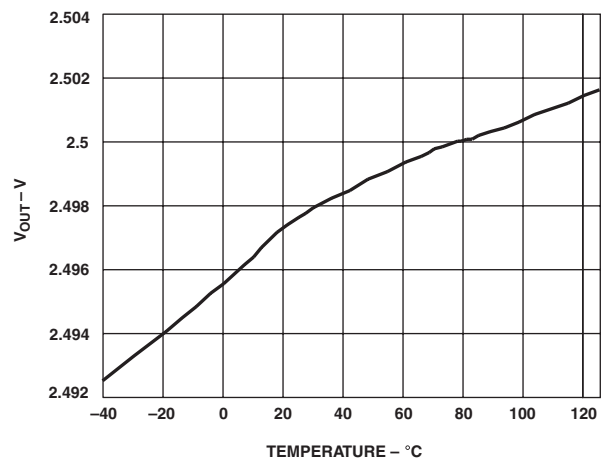

Figure 4. Output Voltage vs. Temperature

AD1582/AD1583/AD1584/AD1585

VOLTAGE OUTPUT NONLINEARITY VERSUS TEMPERATURE

When using a voltage reference with data converters, it is important to understand the impact that temperature drift can have on the converter's performance. The nonlinearity of the reference output drift represents additional error that cannot easily be calibrated out of the overall system. To better understand the impact such a drift can have on a data converter, refer to Figure 5 where the measured drift characteristic is normalized to the endpoint average drift. The residual drift error of the AD1582 of approximately 200 ppm demonstrates that this family of references is compatible with systems that require 12-bit accurate temperature performance.

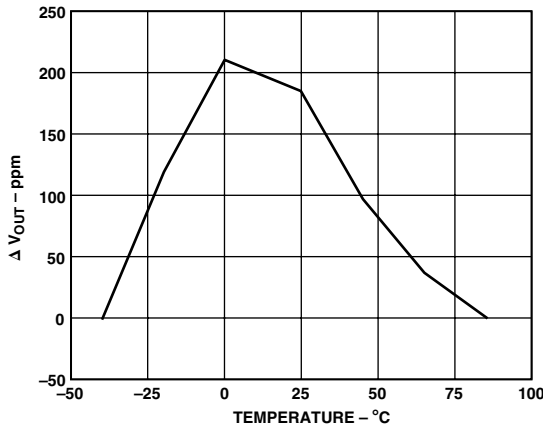

Figure 5. Residual Drift Error

OUTPUT VOLTAGE HYSTERESIS

High performance industrial equipment manufacturers may require the AD1582/AD1583/AD1584/AD1585 family to maintain a consistent output voltage error at 25°C after the references are operated over the full temperature range. While all references exhibit a characteristic known as output voltage hysteresis, the AD1582/AD1583/AD1584/AD1585 family is designed to minimize this characteristic. This phenomenon can be quantified by measuring the change in the +25°C output voltage after temperature excursions from +125°C to +25°C, and from -40°C to +25°C. Figure 6 displays the distribution of the AD1582 output voltage hysteresis.

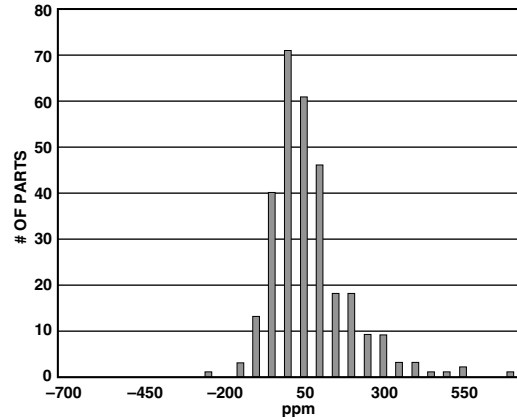

Figure 6. Output Voltage Hysteresis Distribution

SUPPLY CURRENT VERSUS TEMPERATURE

The quiescent current for the AD1582/AD1583/AD1584/AD1585 family of references varies slightly over temperature and input supply range. Figure 7 demonstrates the typical performance for the AD1582 reference when varying both temperature and supply voltage. As is evident from the graph, the AD1582 supply current increases only 1.0 μA/V, making this device extremely attractive for use in applications where there may be wide variations in supply voltage and a need to minimize power dissipation.

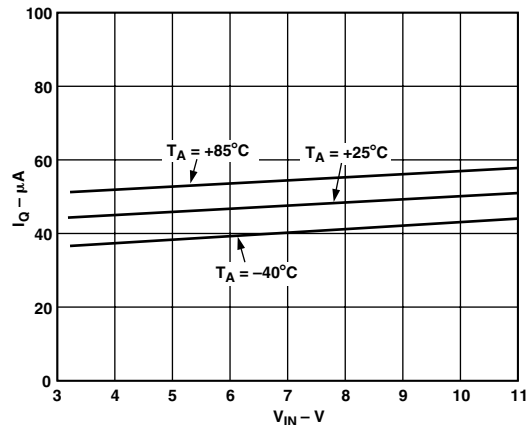

Figure 7. Typical Supply Current over Temperature

SUPPLY VOLTAGE

One of the ideal features of AD1582/AD1583/AD1584/AD1585 is its low supply voltage headroom. The part can operate at supply voltage as low as 200 mV above V_{OUT} and up to 12 V. However, if negative voltage is inadvertently applied to V_{IN} with respect to ground or any negative transient, >5 V is coupled to V_{IN} and the device may be damaged.

AC PERFORMANCE

To apply the AD1582/AD1583/AD1584/AD1585 family of references, it is important to understand the effects of dynamic output impedance and power supply rejection. In Figure 8a, a voltage divider is formed by the AD1582's output impedance and by the external source impedance. Figure 8b shows the effect of varying the load capacitor on the reference output. Power supply rejection ratio (PSRR) should be determined when characterizing the ac performance of a series voltage reference. Figure 9a shows a test circuit used to measure PSRR, and Figure 9b demonstrates the AD1582's ability to attenuate line voltage ripple.

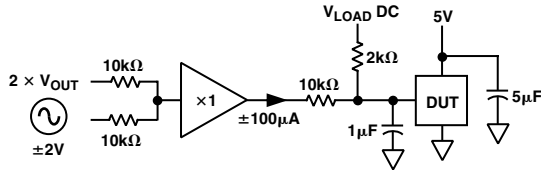

Figure 8a. Output Impedance Test Circuit

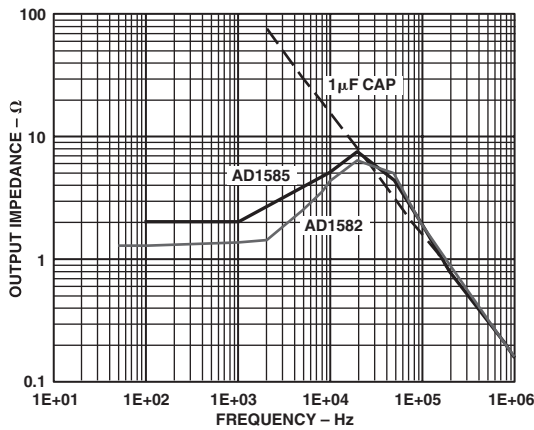

Figure 8b. Output Impedance vs. Frequency

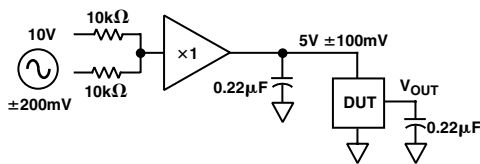

Figure 9a. Ripple Rejection Test Circuit

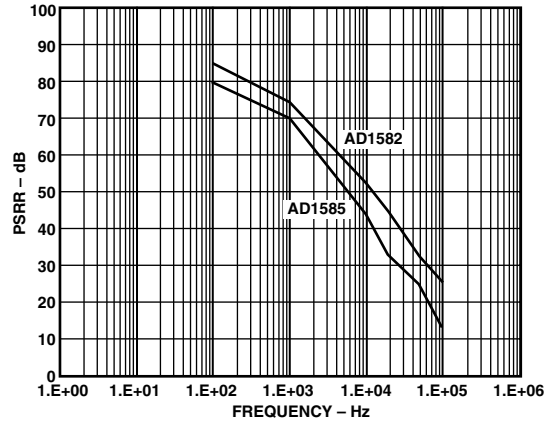

Figure 9b. Ripple Rejection vs. Frequency

NOISE PERFORMANCE AND REDUCTION

The noise generated by the AD1582 is typically less than 70 μV p-p over the 0.1 Hz to 10 Hz frequency band. Figure 10 shows the 0.1 Hz to 10 Hz noise of a typical AD1582. The noise measurement is made with a high gain band-pass filter. Noise in a 10 Hz to 10 kHz region is approximately 50 μV rms. Figure 11 shows the broadband noise of a typical AD1582. If further noise reduction is desired, a 1-pole low-pass filter may be added between the output pin and the ground. A time constant of 0.2 ms has a -3 dB point at roughly 800 Hz, and reduces the high frequency noise to about 16 μV rms. It should be noted, however, that while additional filtering on the output may improve the noise performance of the AD1582/AD1583/AD1584/AD1585 family, the added output impedance could degrade the ac performance of the references.

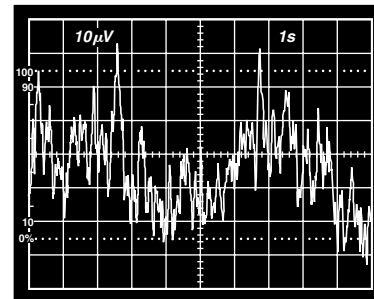

Figure 10. 0.1 Hz to 10 Hz Voltage Noise

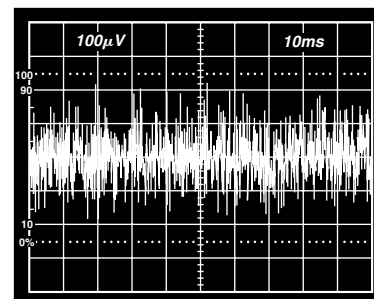

Figure 11. 10 Hz to 10 kHz Wideband Noise

AD1582/AD1583/AD1584/AD1585

TURN-ON TIME

Many low power instrument manufacturers are becoming increasingly concerned with the turn-on characteristics of the components being used in their systems. Fast turn-on components often enable the end user to save power by keeping power off when it is not needed. Turn-on settling time is defined as the time required, after the application of power (cold start), for the output voltage to reach its final value within a specified error. The two major factors affecting this are the active circuit settling time and the time required for the thermal gradients on the chip to stabilize. Figure 12a shows the turn-on settling and transient response test circuit. Figure 12b shows the turn-on characteristic of the AD1582. This characteristic is generated from cold-start operation and represents the true turn-on waveform after power-up. Figure 12c shows the fine settling characteristics of the AD1582. Typically, the reference settles to within 0.1% of its final value in about 100 μ s.

The device can momentarily draw excessive supply current when V_{SUPPLY} is slightly below the minimum specified level. Power supply resistance must be low enough to ensure reliable turn-on. Fast power supply edges minimize this effect.

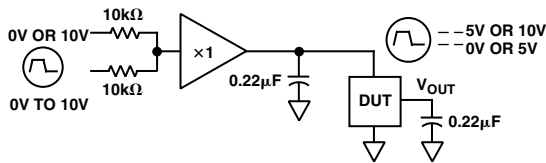

Figure 12a. Turn-On/Transient Response Test Circuit

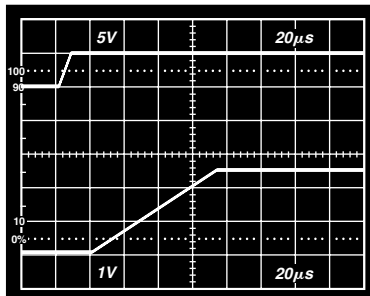

Figure 12b. Turn-On Characteristics

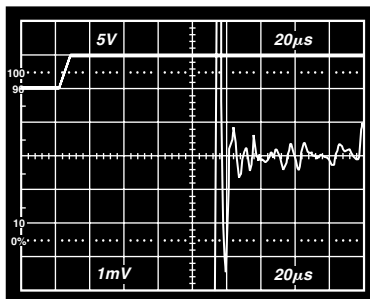

Figure 12c. Turn-On Settling

DYNAMIC PERFORMANCE

Many A/D and D/A converters present transient current loads to the reference, and poor reference response can degrade the converter's performance. The AD1582/AD1583/AD1584/AD1585 family of references provides superior static and dynamic line and load regulation. Since these series references are capable of both sourcing and sinking large current loads, they exhibit excellent settling characteristics.

Figure 13 displays the line transient response for the AD1582. The circuit used to perform such a measurement is shown in Figure 12a, where the input supply voltage is toggled from 5 V to 10 V and the input and output capacitors are each 0.22 μ F.

Figures 14 and 15 show the load transient settling characteristics for the AD1582 when load current steps of 0 mA to +5 mA and 0 mA to -1 mA are applied. The input supply voltage remains constant at 5 V, the input decoupling and output load capacitors are 4.7 μ F and 1 μ F respectively, and the output current is toggled. For both positive and negative current loads, the reference responses settle very quickly and exhibit initial voltage spikes less than 10 mV.

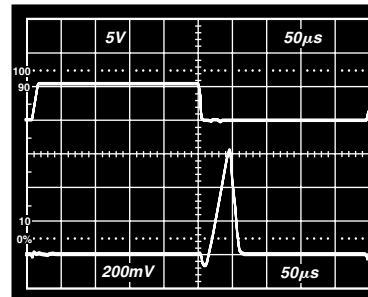

Figure 13. Line Transient Response

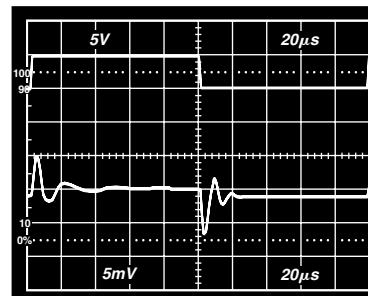

Figure 14. Load Transient Response (0 mA to 5 mA Load)

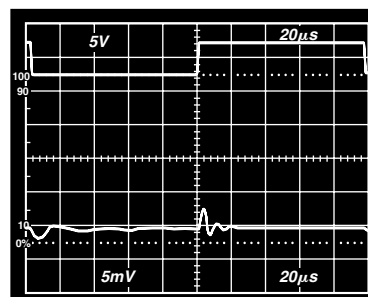
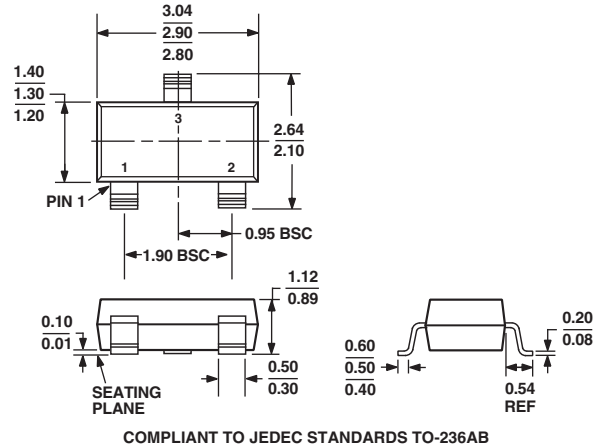

Figure 15. Load Transient Response (0 mA to -1 mA Load)

OUTLINE DIMENSIONS

3-Lead Plastic Surface-Mount Package [SOT-23] (RT-3)

Dimensions shown in millimeters



SOT-23 Tape and Reel

Dimensions shown in millimeters

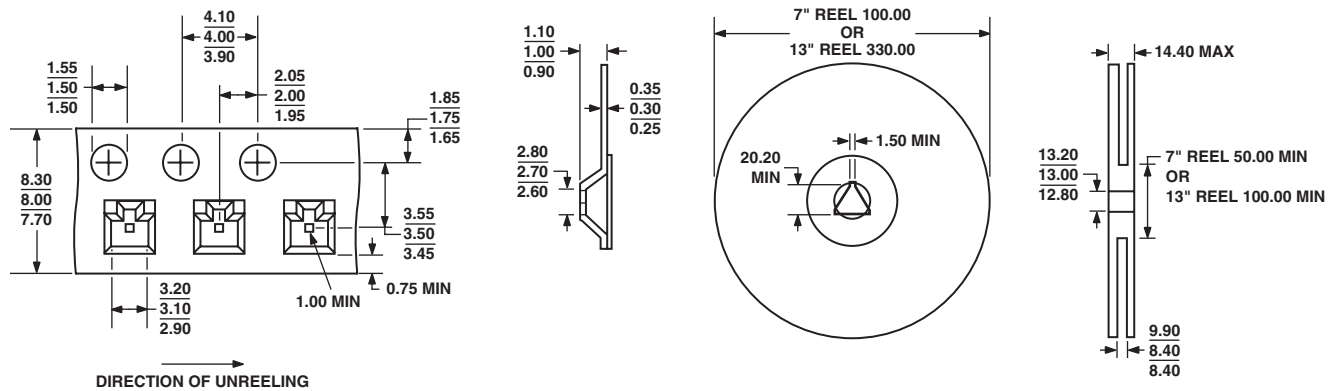

Revision History

Location

Page

12/02—Data Sheet changed from REV. B to REV. C.

Changes to FEATURES	1
Changes to GENERAL DESCRIPTION	1
Changes SPECIFICATIONS	2
Changes to ABSOLUTE MAXIMUM RATINGS	6
TPC 3 replaced	8
Changes to TEMPERATURE PERFORMANCE section	9
Figure 4 replaced	9
Changes to OUTPUT VOLTAGE HYSTERESIS section	10
SOT-23 package updated	13

