

PACKAGE TOP VIEW

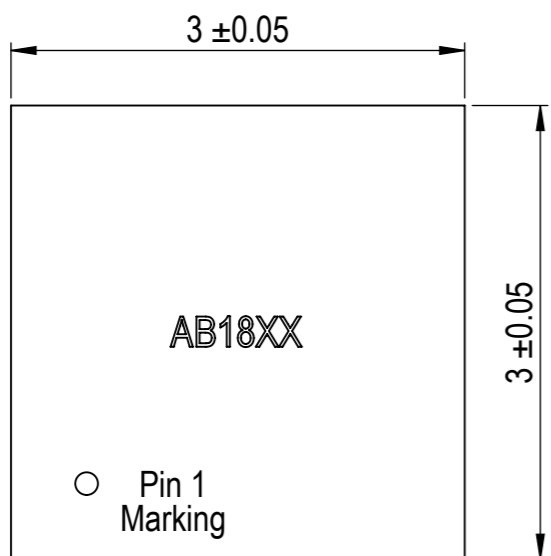

EXAMPLE PCB LAND PATTERN

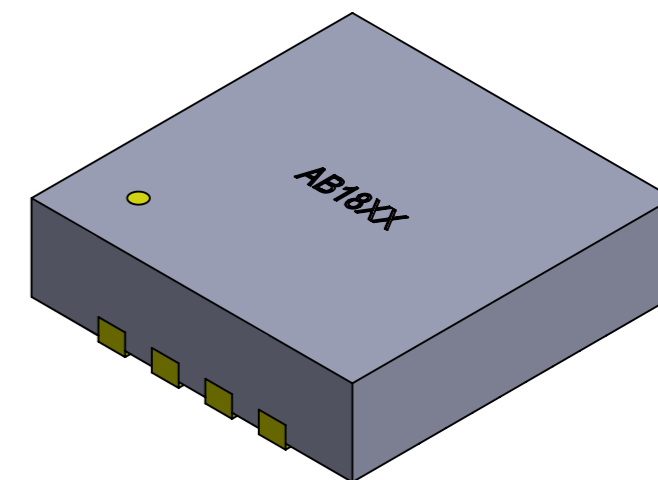
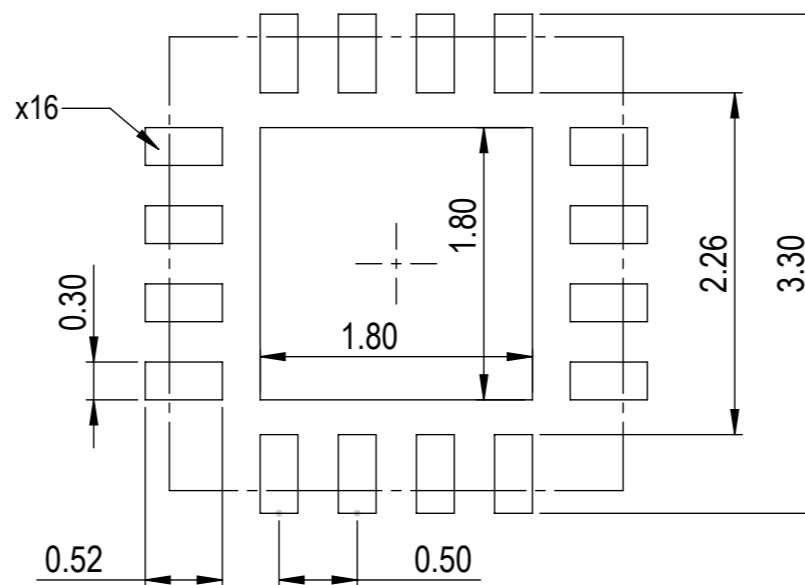

PACKAGE SIDE VIEW

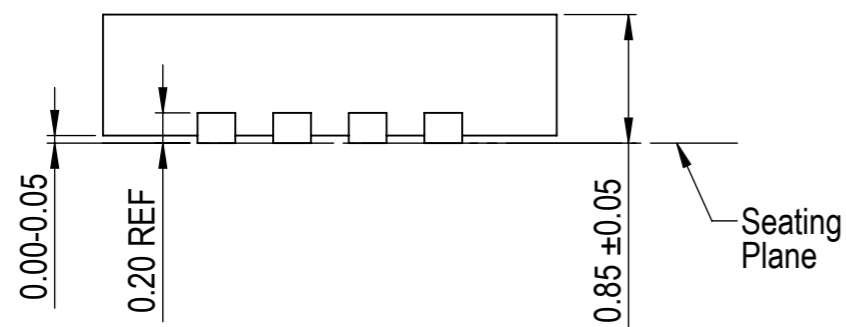

EXAMPLE SOLDER STENCIL

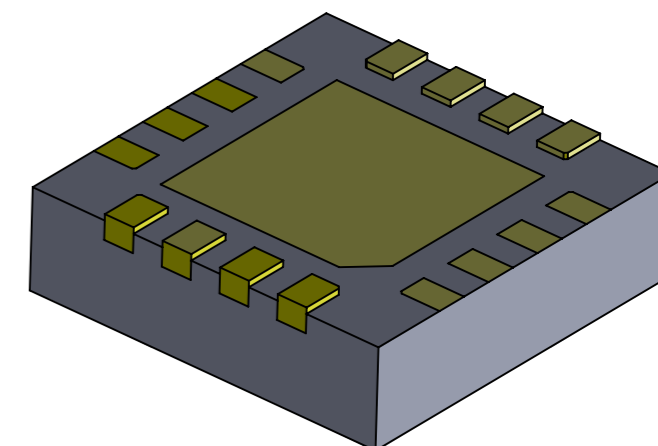
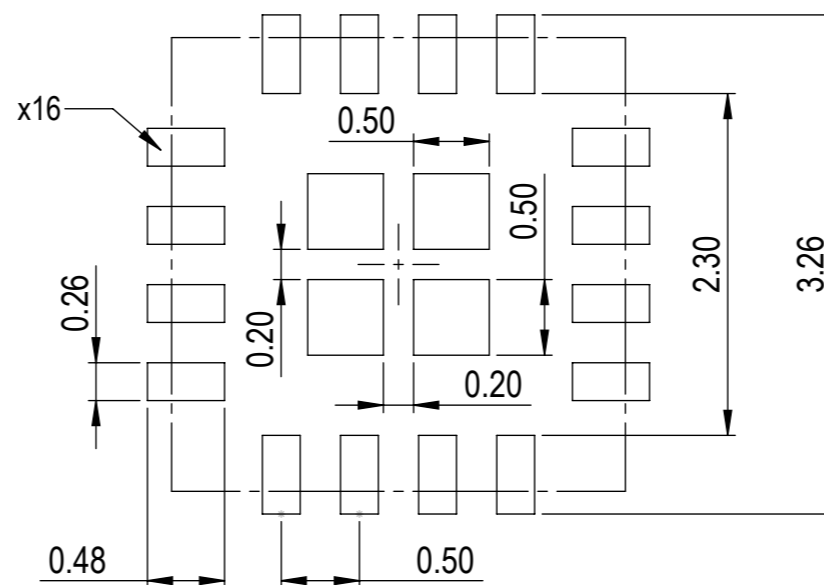

PACKAGE BOTTOM VIEW

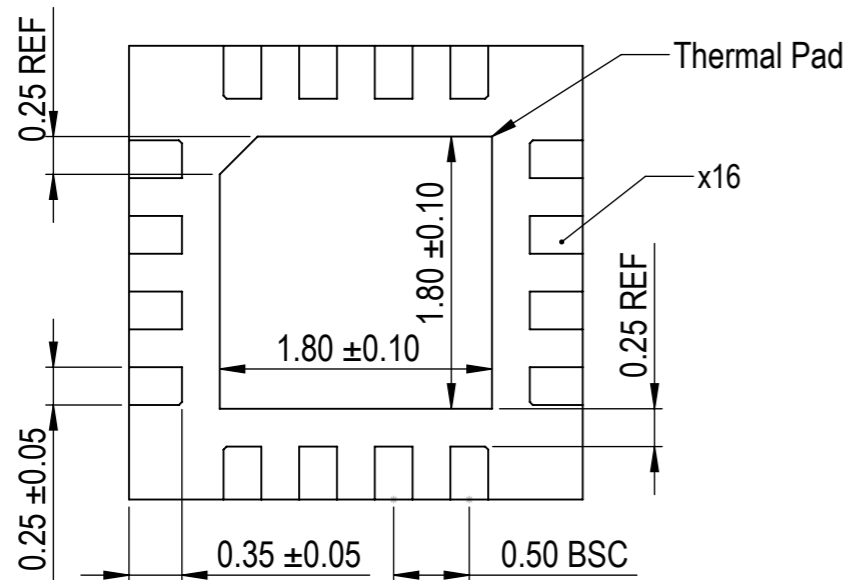

UNLESS OTHERWISE SPECIFIED: DIMENSIONS ARE IN MM SURFACE FINISH: TOLERANCES: LINEAR: ANGULAR:				FINISH:	DEBUR AND BREAK SHARP EDGES	DO NOT SCALE DRAWING	REVISION
							
						30332 Esperanza, Rancho Santa margarita, California 92688	
						TITLE: AB18XX Series Ultra Low Power RTC IC; User's Guide	
						DWG NO.	A3
						SCALE:20:1	
						SHEET 1 OF 1	