

 <b>ABRACON CORPORATION</b> <i>The Power of Linking Together</i>	<b>AB18XX Series</b> <b>Real Time Clock Module</b>	 <b>RoHS Compliant</b>
Date of Issue: Sept. 10 <sup>th</sup> , 2012	<b>3.0 x 3.0 mm</b>	 <b>ESD Sensitive</b>
<i>Page (1) of (13)</i>	<b>Abracon Drawing #</b>	Revision #: Initial Release

## AB18XX Features

- Sub-threshold Power Optimized Technology by Ambiq Micro
- Ultra-low supply current:
  - <15 nA with RC oscillator
  - <20 nA with RC oscillator and autocalibration
  - <55 nA with crystal oscillator
- Baseline timekeeping features:
  - 32 KHz crystal oscillator with integrated load capacitor/resistor
  - Counters for hundredths, seconds, minutes, hours, date, month, year, century, and weekday
  - Alarm capability on all counters
  - Programmable output clock generation (32 kHz to 1/year)
  - Countdown timer with repeat function
  - Automatic leap year calculation
- Advanced timekeeping features:
  - Integrated power optimized RC oscillator
  - Advanced crystal calibration to  $\pm 2$  ppm
  - Advanced RC calibration to  $\pm 16$  ppm
  - Automatic calibration of RC oscillator to crystal oscillator
  - Watchdog timer with hardware reset
  - Up to 256 bytes of general purpose RAM
- Power management features:
  - Integrated  $<1\Omega$  power switch for off-chip components such as a host MCU
  - System sleep manager for managing host processor wake/sleep states
  - External interrupt monitor
  - External reset signal monitor
  - Reset output generator
  - Automatic switchover to VBAT
  - Supercapacitor trickle charger with programmable charging current
  - Programmable brown out detection
  - Programmable analog voltage comparator
- I<sup>2</sup>C (up to 400 kHz) or SPI (up to 2 MHz) serial interface
  - Supports 3-wire and 4-wire SPI
- Operating Voltage 1.7-3.6 V
- Clock and RAM retention voltage 1.5-3.6 V
- Operating temperature -40 to 85 °C
- All inputs include Schmitt triggers
- 3 mm x 3 mm QFN-16 package



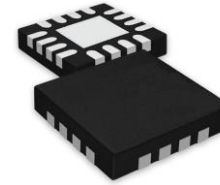

## Applications

- Smart cards
- Wireless sensors and tags
- Medical electronics
- Utility meters
- Data loggers
- Appliances
- Handsets
- Consumer electronics

## Description

The Abracon Corporation AB18XX Real Time Clock with Power Management family provides a groundbreaking combination of ultra-low power coupled with a highly sophisticated feature set. With power requirements significantly lower than any other industry RTC (as low as 15nA), these are the first semiconductor products based on Abracon Corporation's innovative SPOT (Sub-threshold Power Optimized Technology by Ambiq Micro) CMOS platform. The AB18XX includes on-chip oscillators to provide minimum power consumption, full RTC functions including battery backup and programmable counters and alarms for timer and watchdog functions, and either an I<sup>2</sup>C or SPI serial interface for communication with a host controller. An integrated power switch and a sophisticated system sleep manager with counter, timer, alarm, and interrupt capabilities allows the AB18XX to be used as a supervisory component in a host microcontroller-based system.

 <b>ABRACON CORPORATION</b> <i>The Power of Linking Together</i>	<b>AB18XX Series</b> <b>Real Time Clock Module</b>	 <b>RoHS Compliant</b>
Date of Issue: Sept. 10 <sup>th</sup> , 2012	<b>3.0 x 3.0 mm</b>	 <b>ESD Sensitive</b>
<i>Page (1) of (13)</i>	<b>Abracon Drawing #</b>	Revision #: Initial Release

## 1. Family Summary

The AB18XX family consists of several members. All devices are supplied in a standard 3 mm x 3 mm QFN-16 package. Members of the software and pin compatible AB08XX RTC family are also listed.

Part #	Baseline Timekeeping		Advanced Timekeeping				Power Management				Interface
	XT Osc	Number of GP Outputs	RC Osc	Calib/ Auto-calib	Watch-dog	RAM (B)	VBAT Switch	Reset Mgmt	Ext Int	Power Switch and Sleep FSM	
AB1801	■	2	■	■		0				■	I <sup>2</sup> C
AB1803	■	2	■	■		64	■			■	I <sup>2</sup> C
AB1804	■	4	■	■	■	256		■	■	■	I <sup>2</sup> C
AB1805	■	4	■	■	■	256	■	■	■	■	I <sup>2</sup> C
AB1811	■	2	■	■		0				■	SPI
AB1813	■	2	■	■		64	■			■	SPI
AB1814	■	3	■	■	■	256		■	■	■	SPI
AB1815	■	3	■	■	■	256	■	■	■	■	SPI
<b>Software and Pin Compatible AB08XX Family Components</b>											
AB0801	■	2	■	■		0					I <sup>2</sup> C
AB0803	■	2	■	■		64	■				I <sup>2</sup> C
AB0804	■	4	■	■	■	256			■		I <sup>2</sup> C
AB0805	■	4	■	■	■	256	■		■		I <sup>2</sup> C
AB0811	■	2	■	■		0					SPI
AB0813	■	2	■	■		64	■				SPI
AB0814	■	3	■	■	■	256			■		SPI
AB0815	■	3	■	■	■	256	■		■		SPI

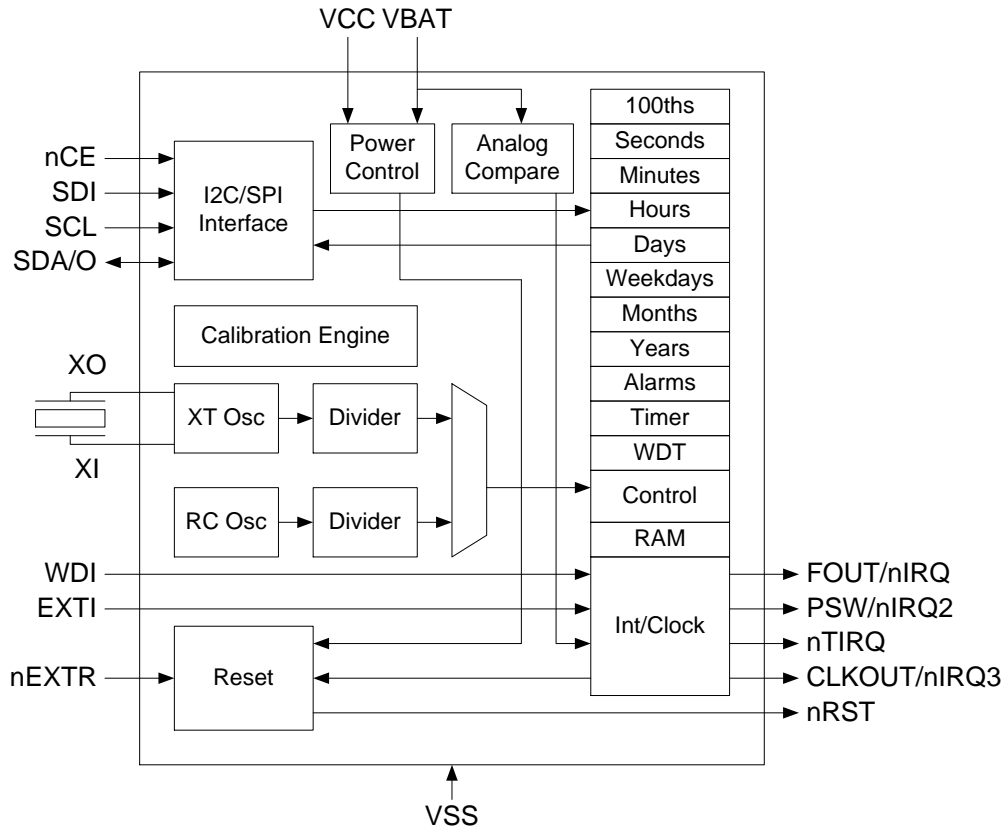

## 2. AB18XX Functional Description



The AB18XX serves as a companion part for host processors including microcontrollers, radios, and digital signal processors. It tracks time as in a typical RTC product and additionally provides unique power management functionality that makes it ideal for highly energy-constrained applications. To support such operation, the AB18XX includes 3 distinct feature groups: 1) baseline timekeeping features, 2) advanced timekeeping features, and 3) power management features. Functions from each feature group may be controlled via memory mapped registers. These registers are accessed using either an I<sup>2</sup>C serial interface (e.g., in the AB1805) or a SPI serial interface (e.g., in the AB1815). Each feature group is described briefly below.

The baseline timekeeping feature group supports the standard 32 kHz crystal (XT) oscillation mode for maximum frequency accuracy with an ultra-low current draw of 55 nA. An extended calibration mode enables low jitter digital calibration to an accuracy of  $\pm 2$  ppm over a range of -614 ppm to +244 ppm. The baseline timekeeping feature group also includes a standard set of counters monitoring hundredths of a second up through centuries. A complement of countdown timers and alarms may additionally be set to initiate interrupts or resets on several of the outputs.

The advanced timekeeping feature group supports two additional oscillation modes: 1) RC oscillator mode, and 2) auto-calibration mode. At only 15 nA, the temperature-compensated  $\pm 10\%$  RC oscillator mode provides an even lower current draw than the XT oscillator for applications with reduced frequency accuracy requirements. A proprietary calibration algorithm allows the AB18XX to digitally tune the RC oscillator frequency with accuracy as low as  $\pm 2$  ppm at a given temperature and very low calibration jitter. In autocalibration mode, the RC oscillator is used as the primary oscillation source and is periodically calibrated against the XT oscillator. Autocalibration may be executed every autocalibration period (ACP) of 8.5 minutes or 17 minutes and may also be initiated via software. This mode enables average current draw of only 20 nA with frequency accuracy similar to the XT oscillator. The advanced timekeeping feature group also includes a rich set of input and output configuration options that enables the monitoring of external interrupts (e.g., pushbutton signals), the generation of clock outputs, and watchdog timer functionality.

 <b>ABRACON CORPORATION</b> <i>The Power of Linking Together</i>	<b>AB18XX Series</b> <b>Real Time Clock Module</b>	 <b>RoHS Compliant</b>
Date of Issue: Sept. 10 <sup>th</sup> , 2012	<b>3.0 x 3.0 mm</b>	 <b>ESD Sensitive</b>
<i>Page (3) of (13)</i>	<b>Abracon Drawing #</b>	Revision #: Initial Release

Power management features built into the AB18XX enable it to operate as a backup device in both line-powered and battery-powered systems. An integrated power control module automatically detects when main power (VCC) falls below a digitally-selectable threshold and switches to backup power (VBAT). Up to 256B of ultra-low leakage RAM enable the storage of key parameters when operating on backup power.

The AB18XX is the first RTC to incorporate a number of more advanced power management features. In particular, the AB18XX includes a finite state machine (integrated with the Power Control block) that can control a host processor as it transitions between sleep/reset states and active states. Digital outputs can be configured to control the reset signal or interrupt input of the host controller with digitally-tunable timing. The AB18XX additionally integrates a power switch with <math><1 \Omega</math> impedance that can be used to cut off ground current on the host microcontroller and reduce sleep current to <math><1 \text{ nA}</math>. The AB18XX parts can wake-up a sleeping system using internally generated timing interrupts or externally generated interrupts generated by digital inputs (e.g., using a pushbutton). The aforementioned functionality enables users to seamlessly power down host processors, leaving only the energy-efficient AB18XX chip awake. The AB18XX also includes digitally-tunable voltage monitoring for brown-out detection and power-on reset.

### 3. AB18XX Example Applications

The AB18XX enables a variety of system implementations in which the AB18XX can control power usage by other elements in the system. This is typically used when the entire system is powered from a battery and minimizing total power usage is critical. The backup RAM in the AB18XX can be used to hold key MCU parameters when it is powered down.

#### 3.1 VSS Power Switched

In the recommended implementation, the internal power switch of the AB18XX is used to completely turn off the MCU and/or other system elements. In this case the PSW/nIRQ2 output is configured to generate the Sleep function. Under normal circumstances, the PSW/nIRQ2 pin is pulled to VSS with less than 1 ohm of resistance, so that the MCU receives full power. The MCU initiates a SLP operation, and when the AB18XX enters Sleep Mode the PSW/nIRQ2 pin is opened and power is completely removed from the MCU. This results in significant additional power savings relative to the other alternatives. A variety of interrupts, including alarms, timers and external interrupts created by a pushbutton as shown, may be used to exit Sleep Mode and restore MCU power. The RAM of the AB18XX may be used to retain critical MCU parameters.

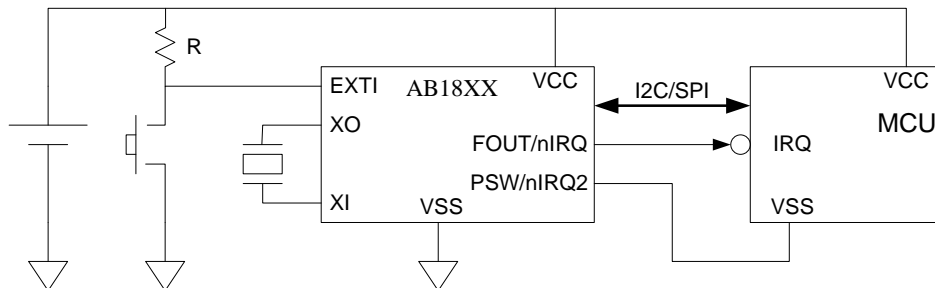

### 3.2 VCC Power Switched

An external transistor switch T may also be used to turn off power to the MCU. This implementation allows switching higher current and maintains a common ground. R can be on the order of megohms, so that negligible current is drawn when the circuit is active and PSW/nIRQ2 is low.

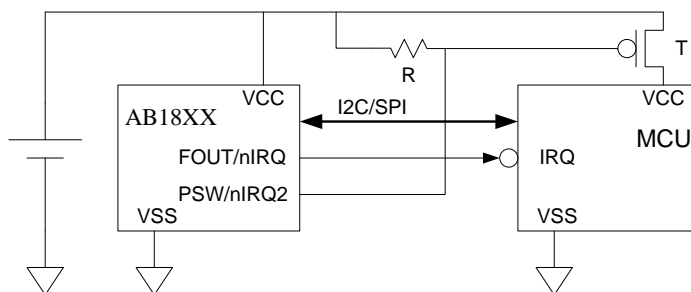

### 3.3 Reset Driven

In another implementation the AB18XX controls the system MCU using the reset function rather than switching power. Since many MCUs use much less power when reset, this implementation can save system power in some cases.

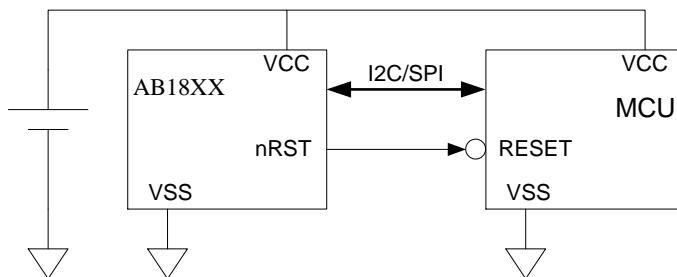

### 3.4 Battery Backup

In many systems the main power supply is a battery, so the AB18XX can minimize its current draw by powering down the MCU and other peripherals. This battery may be replaceable, and a supercapacitor charged via the AB18XX trickle charger can maintain system time and key parameters when the main battery is removed.

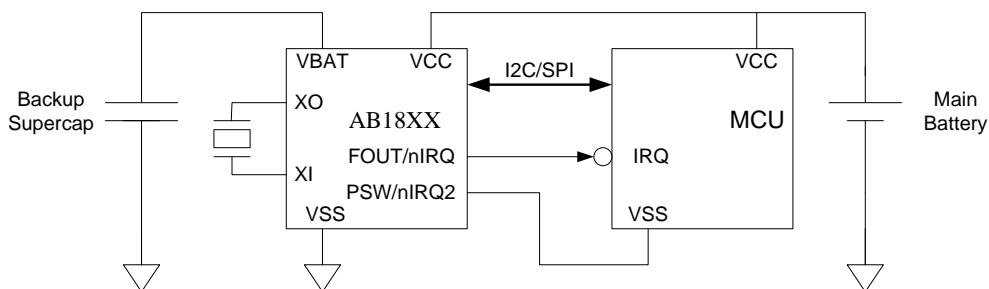



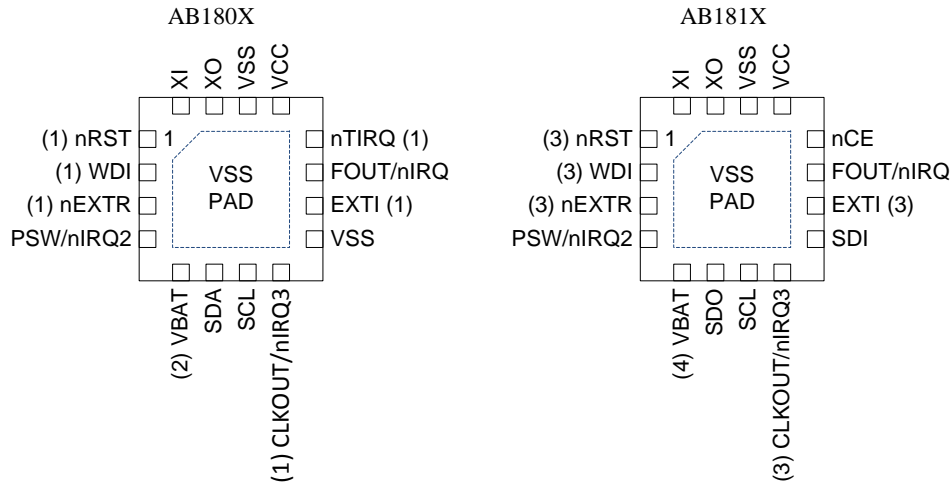

## 4. Package Pin Description

The AB18XX package pins are described below. The thermal pad on the QFN-16 packages must be connected to VSS. All NC pins must be left unconnected.



- (1) – Available in AB1804 and AB1805 only, else NC  
 (2) – Available in AB1803 and AB1805 only, else VSS  
 (3) – Available in AB1814 and AB1815 only, else NC  
 (4) – Available in AB1813 and AB1815 only, else VSS

Pin Name	Pin Type	Function	Pin Number in AB18XX							
			01	03	04	05	11	13	14	15
VSS	Power	Ground	5, 9, 14	9, 14	5, 9, 14	9, 14	5, 14	14	5, 14	14
VCC	Power	System power supply	13	13	13	13	13	13	13	13
XI	XT	Crystal input	16	16	16	16	16	16	16	16
XO	XT	Crystal output	15	15	15	15	15	15	15	15
VBAT	Power	Battery power supply		5		5		5		5
SCL	Input	I <sup>2</sup> C or SPI interface clock	7	7	7	7	7	7	7	7
SDO	Output	SPI data output					6	6	6	6
SDI	Input	SPI data input					9	9	9	9
nCE	Input	SPI chip select					12	12	12	12
SDA	Input	I <sup>2</sup> C data input/output	6	6	6	6				
EXTI	Input	External interrupt input			10	10			10	10
WDI	Input	Watchdog reset input			2	2			2	2
nEXTR	Input	External reset input			3	3			3	3
FOUT/nIRQ	Output	Interrupt 1/function output	11	11	11	11	11	11	11	11
PSW/nIRQ2	Output	Interrupt 2/power switch output	4	4	4	4	4	4	4	4
CLKOUT/nIRQ3	Output	Interrupt 3/clock output			8	8			8	8
nTIRQ	Output	Timer interrupt output			12	12				
nRST	Output	Reset output			1	1			1	1

 The Power of Linking Together	<b>AB18XX Series</b> <b>Real Time Clock Module</b>	 <b>RoHS Compliant</b>
Date of Issue: Sept. 10 <sup>th</sup> , 2012	<b>3.0 x 3.0 mm</b>	 <b>ESD Sensitive</b>
Page (6) of (13)	<b>Abracon Drawing #</b>	Revision #: Initial Release

## 5. Electrical Specifications

### 5.1 Absolute Maximum Ratings



All voltages referenced to VSS.

SYMBOL	PARAMETER	TEST CONDITIONS	MIN	TYP	MAX	UNIT
V <sub>CC</sub>	System Power Voltage		-0.3		3.6	V
V <sub>BAT</sub>	Battery Voltage		-0.3		3.6	V
V <sub>I</sub>	Input voltage	V <sub>CC</sub> > V <sub>MIN</sub>	-0.3		V <sub>CC</sub> + 0.3	V
V <sub>I</sub>	Input voltage	V <sub>CC</sub> < V <sub>MIN</sub> , V <sub>BAT</sub> > V <sub>MIN</sub>	-0.3		V <sub>BAT</sub> + 0.3	V
V <sub>O</sub>	Output voltage	V <sub>CC</sub> > V <sub>MIN</sub>	-0.3		V <sub>CC</sub> + 0.3	V
V <sub>O</sub>	Output voltage	V <sub>CC</sub> < V <sub>MIN</sub> , V <sub>BAT</sub> > V <sub>MIN</sub>	-0.3		V <sub>BAT</sub> + 0.3	V
I <sub>I</sub>	Input current		-1		1	mA
I <sub>O</sub>	Output current		-1		1	mA
V <sub>ESD</sub>	ESD Voltage	CDM			±500	V
		HBM			±4000	V
I <sub>LU</sub>	Latch-up Current				100	mA
T <sub>STG</sub>	Storage Temperature		-65		150	°C
T <sub>OP</sub>	Operating Temperature		-40		85	°C
T <sub>SLD</sub>	Lead temperature	Hand soldering for 10 seconds			300	°C
T <sub>REF</sub>	Reflow soldering temperature	Reflow profile per JEDEC J-STD-020D			260	°C

### 5.2 Operating Parameters

T<sub>A</sub> = -40 °C to 85 °C, TYP values at 25 °C

SYMBOL	PARAMETER	TEST CONDITIONS	MIN	TYP	MAX	UNIT
V <sub>CC</sub>	System Power Voltage	SPI or I <sup>2</sup> C active	1.7		3.6	V
		Clock operating + RAM	1.5		3.6	V
V <sub>BAT</sub>	Battery Voltage	Clock operating + RAM	1.5		3.6	V
V <sub>T+</sub>	Positive-going Input Threshold Voltage	V <sub>CC</sub> = 3.0V		1.5		V
		V <sub>CC</sub> = 1.8V		1.1		V
V <sub>T-</sub>	Negative-going Input Threshold Voltage	V <sub>CC</sub> = 3.0V		0.9		V
		V <sub>CC</sub> = 1.8V		0.6		V
V <sub>OL</sub>	Low level output voltage	1.7V < V <sub>CC</sub> < 3.6V	VSS	0.2•VCC		V
V <sub>OH</sub>	High level output voltage on push-pull outputs	1.7V < V <sub>CC</sub> < 3.6V		0.8•VCC	VCC	V
V <sub>MIN</sub>	Power supply valid voltage			1.5		V

 <b>ABRACON CORPORATION</b> <i>The Power of Linking Together</i>	<b>AB18XX Series</b> <b>Real Time Clock Module</b>	 <b>RoHS Compliant</b>
Date of Issue: Sept. 10 <sup>th</sup> , 2012	<b>3.0 x 3.0 mm</b>	 <b>ESD Sensitive</b>
Page (7) of (13)	<b>Abracon Drawing #</b>	Revision #: Initial Release

### 5.3 Supply Current

The current supplied into the VCC or VBAT power inputs under various conditions is shown below.

$T_A = -40\text{ }^{\circ}\text{C}$  to  $85\text{ }^{\circ}\text{C}$ ,  $V_{BAT} = 0\text{ V}$  to  $3.6\text{ V}$ , TYP values at  $25\text{ }^{\circ}\text{C}$

SYMBOL	PARAMETER	TEST CONDITIONS	V <sub>CC</sub>	V <sub>BAT</sub>	MIN	TYP	MAX	UNIT
I <sub>VCC:I2C</sub>	V <sub>CC</sub> supply current during I <sup>2</sup> C burst read/write	400kHz bus speed, 10k pull-up resistors on SCL/SDA. (1)	3.0V	NA		20		μA
			1.8V			10		
I <sub>VCC:SPI</sub>	V <sub>CC</sub> supply current during SPI burst read/write	2 MHz bus speed (2)	3.0V	NA		10		μA
			1.8V			5		
I <sub>VCC:XT</sub>	V <sub>CC</sub> supply current in XT oscillator mode.	Time keeping mode with XT oscillator running. (3)	3.0V	NA		55		nA
			1.8V			50		
I <sub>VCC:RC</sub>	V <sub>CC</sub> supply current in RC oscillator mode.	Time keeping mode with only the RC oscillator running (XT oscillator is off). (3)	3.0V	NA		15		nA
			1.8V			12		
I <sub>VCC:ACAL</sub>	V <sub>CC</sub> supply current in autocalibrated RC oscillator mode.	Time keeping mode with only RC oscillator running and autocalibration enabled. ACP = 512 seconds. (3)	3.0V	NA		18		nA
			1.8V			15		
I <sub>VBAT:XT</sub>	V <sub>BAT</sub> supply current in XT oscillator mode.	Time keeping mode with XT oscillator running. (3)	< 1.5V	3.0V		55		nA
				1.8V		50		
I <sub>VBAT:RC</sub>	V <sub>BAT</sub> supply current in RC oscillator mode.	Time keeping mode with only the RC oscillator running (XT oscillator is off). (3)	< 1.5V	3.0V		15		nA
				1.8V		12		
I <sub>VBAT:ACAL</sub>	V <sub>BAT</sub> supply current in autocalibrated RC oscillator mode.	Time keeping mode with only RC oscillator running and autocalibration enabled. ACP = 512 seconds. (3)	< 1.5V	3.0V		18		nA
				1.8V		15		
I <sub>VBAT:VCC</sub>	V <sub>BAT</sub> supply current in V <sub>CC</sub> powered mode.	V <sub>CC</sub> powered mode. (3)	> 1.5V	3.0V		290		pA
				1.8V		190		

- (1) Excluding external peripherals and pull-up resistor current. All other inputs (besides SDA and SCL) are at 0V or V<sub>CC</sub>. AB080X and AB180X only.
- (2) Excluding external peripheral current. All other inputs (besides SDI, nCE and SCL) are at 0V or V<sub>CC</sub>. AB081X and AB181X only.
- (3) All inputs and outputs are at 0V or V<sub>CC</sub>.



## 6. Tape and Reel Information

### REEL DRAWING

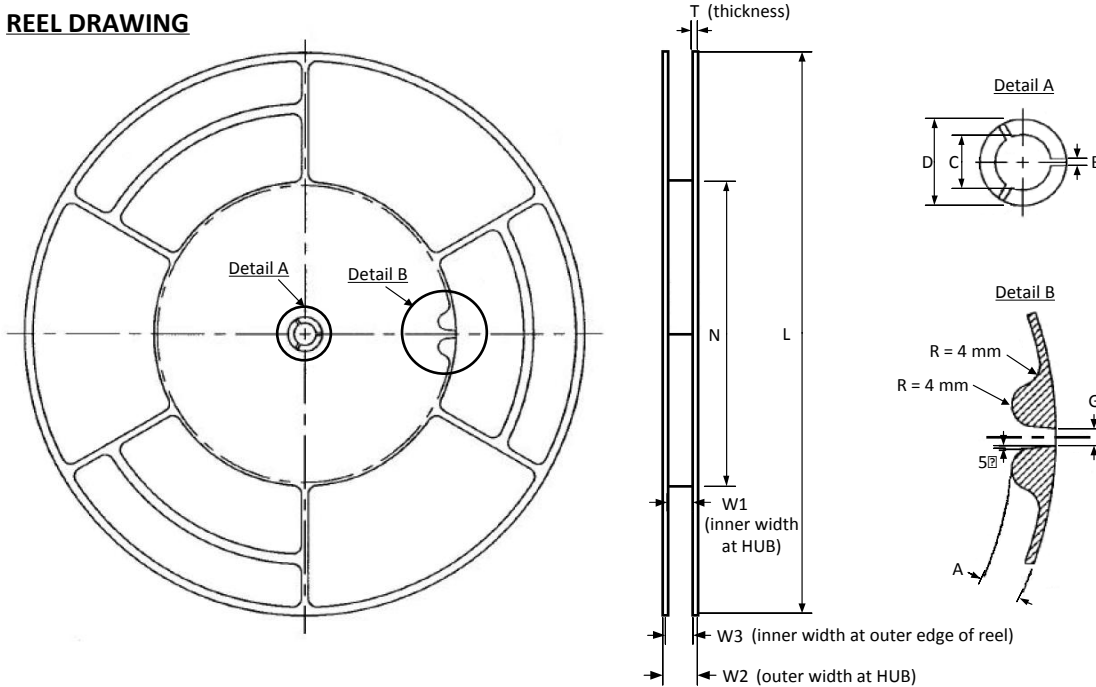

### CARRIER TAPE DRAWING

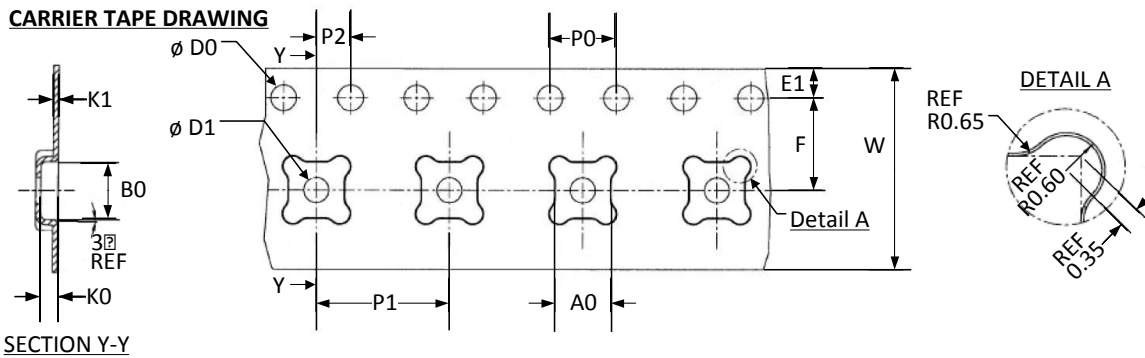

### SECTION Y-Y

330 x 178 x 12 mm Reel Dimensions				3x3 QFN Carrier Tape Dimensions					
Symbol	MIN	TYP	MAX	Units	Symbol	MIN	TYP	MAX	Units
T	2.3	2.5	2.7	mm	B0	3.2	3.3	3.4	mm
N		178.0			K0	0.9	1.0	1.1	
L			330.0		K1	0.25	0.3	0.35	
W1	12.4	12.4	12.6		D0	1.50	1.55	1.60	
W2			18.4		D1	1.5			
W3	12.4		15.4		P0	3.9	4.0	4.1	
C	12.8	13.0	13.5		P1	7.9	8.0	8.1	
D	20.2				P2	1.9	2.0	2.1	
A		10.0			A0	3.2	3.3	3.4	
G		4.0			E1	1.65	1.75	1.85	
B	1.5				F	5.4	5.5	5.6	
					W	11.7	12.0	12.3	



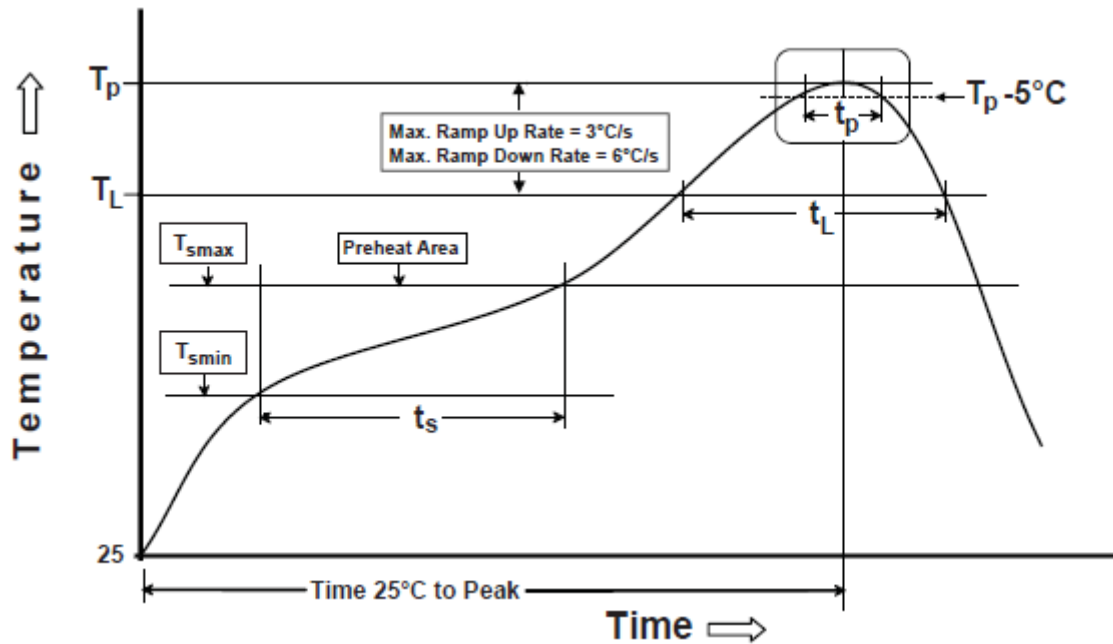

## 7. Reflow Profile

The AB18XX reflow soldering requirements are described below.



Profile Feature	Requirement
Preheat/Soak	
Temperature Min ( $T_{psmin}$ )	150 °C
Temperature Max ( $T_{psmax}$ )	200 °C
Time ( $t_s$ ) from ( $T_{psmin}$ to $T_{psmax}$ )	60-120 seconds
Ramp-up rate ( $T_L$ to $T_p$ )	3 °C/second max.
Liquidous temperature ( $T_L$ )	217 °C
Time ( $t_L$ ) maintained above $T_L$	60-150 seconds
Peak package body temperature ( $T_p$ )	260 °C max.
Time ( $t_p$ ) within 5 °C of $T_p$	30 seconds max.
Ramp-down rate ( $T_p$ to $T_L$ )	6 °C/second max.
Time 25 °C to peak temperature	8 minutes max.

 <b>ABRACON CORPORATION</b> <i>The Power of Linking Together</i>	<b>AB18XX Series</b> <b>Real Time Clock Module</b>	 <b>RoHS Compliant</b>
Date of Issue: Sept. 10 <sup>th</sup> , 2012	<b>3.0 x 3.0 mm</b>	 <b>ESD Sensitive</b>
<i>Page (10) of (13)</i>	<b>Abracon Drawing #</b>	Revision #: Initial Release





## 8. Ordering Information

AB18XX Orderable Part Numbers					
Device	Standard	Tape and Reel - 2500 pcs.	Package	Temperature Range	MSL Level <sup>(2)</sup>
AB1801	AB1801A3XNLGIX	AB1801A3XNLGIX-T2	Pb-Free <sup>(1)</sup> 16-Pin QFN 3 x 3 mm	-40 to +85 °C	1
AB1803	AB1803A3XNLGIX	AB1803A3XNLGIX-T2			
AB1804	AB1804A3XNLGIX	AB1804A3XNLGIX-T2			
AB1805	AB1805A3XNLGIX	AB1805A3XNLGIX-T2			
AB1811	AB1811A3XNLGIX	AB1811A3XNLGIX-T2			
AB1813	AB1813A3XNLGIX	AB1813A3XNLGIX-T2			
AB1814	AB1814A3XNLGIX	AB1814A3XNLGIX-T2			
AB1815	AB1815A3XNLGIX	AB1815A3XNLGIX-T2			

Notes:

<sup>(1)</sup> Compliant and certified with the current RoHS requirements for all 6 substances, including the requirement that lead not exceed 0.1% by weight in raw homogeneous materials. The package was designed to be soldered at high temperatures (per reflow profile) and can be used in specified lead-free processes.

<sup>(2)</sup> Moisture Sensitivity Level rating according to the JEDEC J-STD-020D industry standard classifications.

	<b>AB18XX Series Real Time Clock Module</b>	 
Date of Issue: Sept. 10 <sup>th</sup> , 2012	<b>3.0 x 3.0 mm</b>	 <b>ESD Sensitive</b>
<i>Page (11) of (13)</i>	<b>Abracon Drawing #</b>	Revision #: Initial Release

## 9. Notes

- i) The parts are manufactured in accordance with this specification. If other conditions and specifications which are required for this specification, please contact ABRACON for more information.
- ii) ABRACON will supply the parts in accordance with this specification unless we receive a written request to modify prior to an order placement.
- iii) In no case shall ABRACON be liable for any product failure from in appropriate handling or operation of the item beyond the scope of this specification.
- iv) When changing your production process, please notify ABRACON immediately.
- v) ABRACON Corporation's products are COTS – Commercial-Off-The-Shelf products; suitable for Commercial, Industrial and, where designated, Automotive Applications. ABRACON's products are not specifically designed for Military, Aviation, Aerospace, Life-dependant Medical applications or any application requiring high reliability where component failure could result in loss of life and/or property. For applications requiring high reliability and/or presenting an extreme operating environment, written consent and authorization from ABRACON Corporation is required. Please contact ABRACON Corporation for more information.
- vi) All specifications and Marking will be subject to change without notice.

## 10. ABRACON CORPORATION – TERMS & CONDITIONS OF SALE

**PLEASE NOTE:** Claims for pricing errors, shortages and defective products must be reported within 10 days from receipt of goods. Returned products will not be accepted after 30 days from the invoice date, and may be subject to restocking fees in accordance with Abracon Corporation's return policy. Abracon standard product purchase orders may not be canceled within 60 days of original shipping date. Abracon non-standard product purchase orders are non-cancelable and non-returnable. All schedule changes must be requested prior to 30 days of original shipping date. Maximum schedule change "push-out" shall be no more than 30 days from original shipping date. Abracon reserves the right to review all schedule and quantity changes and make pricing changes as needed. **NO CREDIT WILL BE GIVEN FOR PRODUCTS RETURNED WITHOUT PRIOR AUTHORIZATION.**

Please also note that IN NO EVENT SHALL ABRACON'S TOTAL LIABILITY FOR ANY AND ALL LOSSES AND DAMAGES ARISING OUT OF ANY CAUSE (INCLUDING, BUT NOT LIMITED TO, CONTRACT, NEGLIGENCE, STRICT LIABILITY OR OTHER TORT) EXCEED THE PURCHASE COST OF THE PRODUCTS. IN NO EVENT SHALL ABRACON BE LIABLE FOR ANY INCIDENTAL, CONSEQUENTIAL OR PUNITIVE DAMAGES.





Placing an order with ABRACON constitutes an acknowledgement that you have read and agree to the "Terms and Conditions of Sale."

1. Prices: ABRACON (AB) reserves the right to increase the price of products by written notice to the Buyer at least thirty days prior to the date of shipment of the products. When quantity price discounts are quoted by AB, the discounts are computed separately for each type of product to be sold and are based upon the quantity of each type and each size ordered at any one time. If any order is reduced or cancelled by the Buyer with AB's consent, the prices shall be adjusted to the higher prices, if applicable, for the uncanceled quantity. Unless otherwise agreed, AB reserves the right to ship and bill ten percent more or less than the exact quantity specified.

2. Taxes: Unless otherwise specified in the quotation, the prices shown do not include any taxes, import, or export duties, tariffs, or customs charges. The Buyer agrees to pay AB the amount of any federal, state, county, municipal, or other taxes, duties, tariffs, or custom charges levied by any jurisdiction, foreign or domestic, which AB is required to pay on account of the ownership at the place of installation or during transit of the material or equipment which is the subject of this contract, or an account of the transportation, sale, or use of the material or equipment.

3. Payment Terms: Unless otherwise stated in a separate agreement or in AB's quotation, payment terms are thirty days net from the date of invoice, subject to approval from AB of amount and terms of credit. AB reserves the right to require payment in advance or C.O.D. and otherwise modified credit terms. When partial shipments are made, payments therefore shall become due in accordance with the above terms upon submission of invoices. If, at the request of the Buyer, shipment is postponed for more than thirty days, payment will become due thirty days after notice to the Buyer that products are ready for shipment. These terms apply to partial as well as complete shipments on the debt at the lesser of 18% per year, or the maximum then permitted by California law, from the due date until the Buyer pays the debt in full.

4. Shipment: All shipments will be made F.O.B. AB's shipping point. In the absence of specific instructions, AB will select the carrier. Title to the material shall pass to the Buyer upon delivery thereof by AB to the carrier or delivery service. Thereupon the Buyer shall be responsible therefore. Products held for the Buyer, or stored for the Buyer, shall be at the risk and expense of the Buyer. Claims against AB

	<b>AB18XX Series Real Time Clock Module</b>	 
Date of Issue: Sept. 10 <sup>th</sup> , 2012	<b>3.0 x 3.0 mm</b>	 <b>ESD Sensitive</b>
<i>Page (12) of (13)</i>	<b>Abrakon Drawing #</b>	Revision #: Initial Release

for shortages must be made in writing within ten days after the arrival of the shipment. AB is not required to notify the Buyer of the shipment.

5. Delivery: Shipping dates are approximate.

6. Packing: Unless otherwise specified, prices quoted herein include normal AB packaging. If special packaging is required by the Buyer, an additional charge will be made.

7. Inspection: Unless the Buyer notifies AB in writing within ten days from the date of receipt of any products that says the products are rejected, they will be deemed to have been accepted by the Buyer. In order for the notice of rejection to be effective, it must also specify the reasons why the products are being rejected. Any rejected products must be returned to AB within thirty days of rejection or the rejection shall be void and of no effect. Notwithstanding the preceding sentence, no returned goods will be accepted for credit unless written permission is first obtained from AB.

8. Limitation of Liability: AB shall not be liable for any loss, damage, cost of repairs, or incidental or consequential damages of any kind whether or not based upon express or implied warranty, negligence, or strict liability arising out of or in connection with the design, manufacture, sale, use, repair, or delivery of the product, or the engineering designs supplied to the Buyer. Without limiting the generality of the foregoing: if conditions arise which prevent compliance with delivery schedules, AB shall not be liable for any damage or penalty for delay in delivery, or for failure to give notice of delay, and such delay shall not constitute grounds for cancellation or price adjustment: in addition, AB shall not be liable for delay in delivery without regard to the cause of the delay, and delivery dates shall be deemed extended for a period equal to such delay.

9. Fair Labor Standards Act: AB certifies that products furnished hereunder have been or will be produced in compliance with the Fair Labor Standards Act, as amended and regulations and orders of the U.S. Department of Labor issued thereunder, AB agrees that this statement may be considered as the written assurance contemplated by the October 26, 1949 amendment to said Act.

10. Modifications: Unless otherwise provided, AB reserves the right to modify the specifications of products ordered by the Buyer providing that the modifications do not materially affect the performance.

11. Termination: In the event of the complete or partial termination or cancellation of this order for the convenience of the Government, settlement shall be made by negotiations in accordance with the Termination Clause for Subcontractors set forth in Armed Services Procurement Regulation 8-706. If the Buyer attempts to terminate or cancel this order, entirely or partially, other than for the convenience of the Government, it shall constitute a material breach of contract unless consent to said termination is obtained by the Buyer from AB in writing. In any event, the prices of all items delivered, and all items which have been furnished but not yet delivered, will be adjusted upward to the applicable price for the lesser quantities thereby purchased. AB may terminate or cancel this order in whole or in part at any time prior to the completion of performance by written notice to the Buyer without incurring any liability to the Buyer for breach of contract or otherwise.

12. Indemnity and Waiver of Subrogation: Buyer agrees to indemnify and hold AB harmless from any cost, liability or expense, including attorney's fees, which arises from or relates to any third party claim for personal injury (or death), property damages, or other loss allegedly based upon defective design, material, or workmanship of any product sold or furnished by AB, or allegedly based on any breach by AB of any of its contractual or other obligations. The Buyer represents that any liability insurance policies which the Buyer may have shall provide that subrogation rights against supplies such as AB are waived.

13. Governing Law: The terms of this agreement and all rights and obligations under it shall be governed by the laws of the State of California.

14. Errors: AB reserves the right to correct clerical or stenographic errors or omissions.

15. Entire Contract: The provisions of the Agreement and any accompanying documents constitute all the terms and conditions agreed upon by the parties and replace and supersede any inconsistent provisions on the face and the reverse side of the Purchase Order, Invoice, and Packing Slip. No modifications of this Agreement shall be valid unless in writing and duly signed by a person authorized by AB. The provisions of this Agreement shall not be modified by any usage of trade, or any course of prior dealing or acquiescence in the course of performance.

16. Disputes: Disputes between AB and the Buyer shall be resolved in accordance with the laws of the State of California without resort to said state's Conflict of Law rules. Pending final resolution of a dispute, AB shall proceed diligently with the performance of an order in accordance with AB's decision. In any legal action, arbitration, or other proceeding brought to enforce or interpret the terms of this agreement, the prevailing party shall be entitled to reasonable attorneys' fees and any other costs incurred in that proceeding in addition to any other relief to which it is entitled.