

DESCRIPTION

The 78P2351 is Teridian's second generation Line Interface Unit (LIU) for 155 Mbps (OC-3, STS-3, or STM-1) and 140 Mbps PDH (E4) telecom interfaces. The device is a single chip solution that includes an integrated CDR in the transmit path for flexible NRZ to CMI conversion.

The device can interface to 75Ω coaxial cable using CMI coding or directly to a fiber optics transceiver module using NRZ coding. The 78P2351 is compliant with all respective ANSI, ITU-T, and Telcordia standards for jitter tolerance, generation, and transfer.

APPLICATIONS

- Central Office Interconnects
- DSLAMs
- Add Drop Multiplexers (ADM)s
- PDH/SDH test equipment
- Multi Service Switches
- Digital Microwave Radios

FEATURES

- ITU-T G.703 compliant cable driver for 139.264 Mbps or 155.52 Mbps CMI-coded coax transmission
- Integrated adaptive CMI equalizer and CDR in receive path handles over 12.7dB of cable loss
- Serial, LVPECL-compatible system interface with integrated CRU in transmit path for flexible NRZ to CMI conversion.
- 4-bit parallel CMOS system interface with master and slave Tx clock modes.
- Selectable LVPECL compatible NRZ media interface for 155.52 Mbps optical transmission.
- Configurable via HW control pins or 4-wire serial interface
- Compliant with ANSI T1.105.03-1994; ITU-T G.751, G.813, G.823, G.825, G.958; and Telcordia GR-253-CORE for jitter performance.
- Receiver Loss of Signal (LOS) detection compatible with ITU-T G.783
- Operates from a single 3.3V supply
- 100-pin JEDEC LQFP

BLOCK DIAGRAM

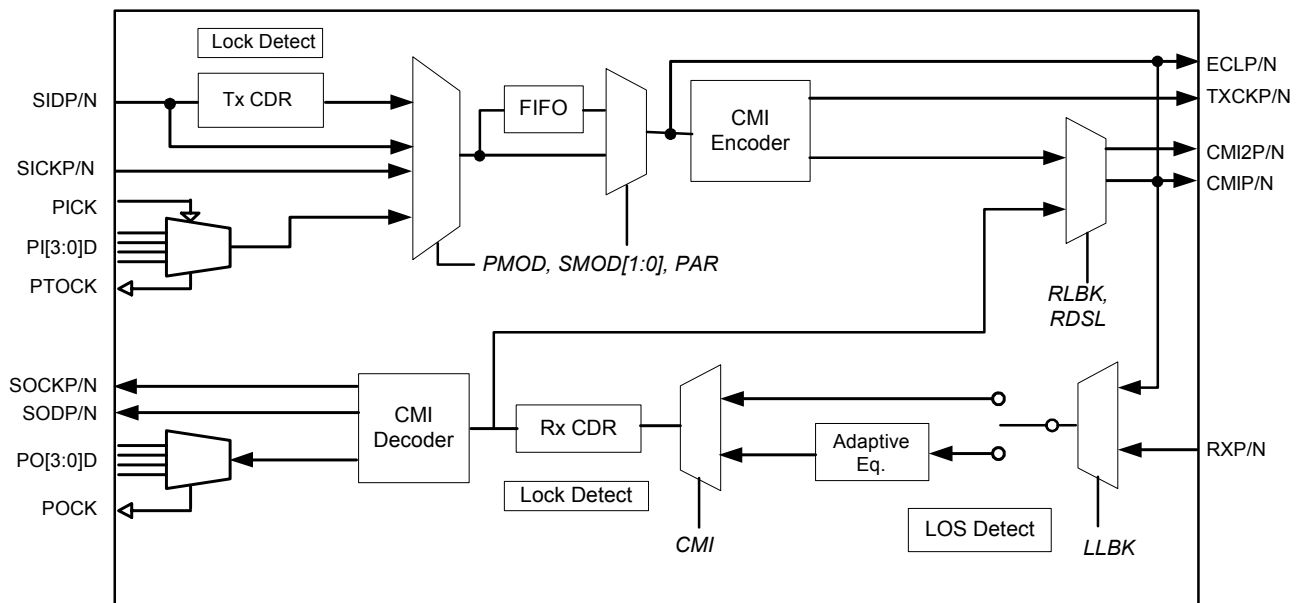

| | |
|--|------------------|
| TABLE OF CONTENTS | 2 |
| FUNCTIONAL DESCRIPTION | 4 |
| MODE SELECTION | 4 |
| REFERENCE CLOCK | 4 |
| RECEIVER OPERATION | 4 |
| <i>Receiver Monitor Mode</i> | <i>4</i> |
| <i>Receive Loss of Signal</i> | <i>5</i> |
| <i>Receive Loss of Lock</i> | <i>5</i> |
| TRANSMITTER OPERATION | 5 |
| <i>Synchronous (Re-timing) Tx Serial Modes</i> | <i>5</i> |
| <i>Plesiochronous Tx Serial Modes</i> | <i>6</i> |
| <i>Synchronous Parallel Modes</i> | <i>6</i> |
| <i>Transmit FIFO Description</i> | <i>6</i> |
| <i>Transmit Driver</i> | <i>7</i> |
| <i>Transmit Monitor Mode</i> | <i>7</i> |
| <i>Clock Synthesizer</i> | <i>7</i> |
| <i>Transmit Backplane Equalizer</i> | <i>7</i> |
| <i>Transmit Loss of Lock</i> | <i>7</i> |
| POWER-DOWN FUNCTION | 7 |
| LOOPBACK MODES | 8 |
| POWER-ON RESET | 8 |
| SERIAL CONTROL INTERFACE | 9 |
| PROGRAMMABLE INTERRUPTS | 9 |
| REGISTER DESCRIPTION | 10 |
| REGISTER ADDRESSING | 10 |
| REGISTER TABLE | 10 |
| LEGEND | 11 |
| <u>GLOBAL REGISTERS</u> | <u>11</u> |
| ADDRESS 0-0: MASTER CONTROL REGISTER | 11 |
| ADDRESS 0-1: INTERRUPT CONTROL REGISTER | 12 |
| ADDRESS 0-2: I/O CONTROL REGISTER | 12 |
| <u>PORT-SPECIFIC REGISTERS</u> | <u>13</u> |
| ADDRESS 1-0: MODE CONTROL REGISTER | 13 |
| ADDRESS 1-1: SIGNAL CONTROL REGISTER | 14 |
| ADDRESS 1-2: ADVANCED TX CONTROL REGISTER 1 | 15 |
| ADDRESS 1-3: ADVANCED TX CONTROL REGISTER 0 | 15 |
| ADDRESS 1-4: MODE CONTROL REGISTER 2 | 15 |
| ADDRESS 1-5: STATUS MONITOR REGISTER | 16 |

TABLE OF CONTENTS (continued)

| | |
|--|-----------|
| PIN DESCRIPTION | 17 |
| LEGEND | 17 |
| TRANSMITTER PINS | 17 |
| RECEIVER PINS | 18 |
| REFERENCE AND STATUS PINS | 19 |
| CONTROL PINS | 20 |
| SERIAL-PORT PINS | 22 |
| POWER AND GROUND PINS | 22 |
| ELECTRICAL SPECIFICATIONS | 23 |
| ABSOLUTE MAXIMUM RATINGS..... | 23 |
| RECOMMENDED OPERATING CONDITIONS | 23 |
| DC CHARACTERISTICS..... | 23 |
| ANALOG PINS CHARACTERISTICS | 24 |
| DIGITAL I/O CHARACTERISTICS | 24 |
| <u>Pins of type CI, CIU, CID</u> | <u>24</u> |
| <u>Pins of type CIT</u> | <u>24</u> |
| <u>Pins of type CIS</u> | <u>24</u> |
| <u>Pins of type CO and COZ</u> | <u>25</u> |
| <u>Pins of type PO</u> | <u>25</u> |
| <u>Pins of type PI</u> | <u>25</u> |
| <u>Pins of type OD</u> | <u>25</u> |
| SERIAL-PORT TIMING CHARACTERISTICS | 26 |
| TRANSMITTER TIMING CHARACTERISTICS | 27 |
| TIMING DIAGRAM: Transmitter Waveforms | 27 |
| REFERENCE CLOCK CHARACTERISTICS | 28 |
| RECEIVER TIMING CHARACTERISTICS | 28 |
| TIMING DIAGRAM: Receive Waveforms | 28 |
| TRANSMITTER SPECIFICATIONS FOR CMI INTERFACE | 29 |
| TRANSMITTER OUTPUT JITTER | 34 |
| RECEIVER SPECIFICATIONS FOR CMI INTERFACE (Transformer-coupled) | 35 |
| RECEIVER JITTER TOLERANCE | 36 |
| RECEIVER JITTER TRANSFER FUNCTION | 38 |
| CMI MODE LOSS OF SIGNAL CONDITION | 39 |
| APPLICATION INFORMATION | 39 |
| EXTERNAL COMPONENTS | 39 |
| (CMI) TRANSFORMER SPECIFICATIONS | 39 |
| THERMAL INFORMATION | 39 |
| MECHANICAL SPECIFICATIONS | 40 |
| PACKAGE INFORMATION | 41 |
| ORDERING INFORMATION | 41 |
| Revision History | 42 |

FUNCTIONAL DESCRIPTION

The 78P2351 contains all the necessary transmit and receive circuitry for connection between 139.264Mbps and 155.52Mbps line interfaces and the digital universe. The chip is controllable through pins or serial port register settings.

In hardware mode (pin control) the SPSL pin must be low.

In software mode (SPSL pin high), control pins are disabled and the 78P2351 must be configured via the 4-wire serial port.

MODE SELECTION

The SDO_E4 pin or E4 register bit determines which rate the device operates in according to the table below. This control combined with CKSL also selects the reference clock frequency.

| Rate | SDO_E4 pin | E4 bit |
|--------------------|------------|--------|
| E4 | High | 1 |
| STM-1, STS-3, OC-3 | Low | 0 |

The SEN_CMI pin or CMI register bit enables the CMI encoder/decoder and selects one of two media for reception and transmission: 75Ω coaxial cable in CMI coding or optical fiber in Fiber (NRZ) mode.

| Media (coding) | SEN_CMI pin | CMI bit |
|----------------|-------------|---------|
| 75Ω Coax (CMI) | High | 1 |
| Fiber (NRZ) | Low | 0 |

The SDI_PAR pin or PAR register bit selects the interface to the framer to be 4-bit parallel CMOS or serial LVPECL. For each interface there are different transmit timing modes available. See TRANSMITTER OPERATION section for more info.

REFERENCE CLOCK

The 78P2351 requires a reference clock supplied to the CKREFP/N pins. This reference clock is used for clock recovery in the Rx DLL and Tx DLL. It is also used for transmit re-timing in the synchronous transmit modes. Refer to the TRANSMITTER OPERATION section for timing requirements during synchronous (re-timing) transmit modes.

For reference frequencies of 77.76MHz or lower, the device accepts a single ended CMOS clock at CKREFP (with CKREFN grounded). For reference frequencies of 139.264 or 155.52MHz, the device accepts a differential LVPECL clock input at CKREFP/N.

The frequency of this reference input is controlled by the rate selection and the CKSL control pin or register bit.

| CKSL pin | Reference Frequency | |
|----------------|---------------------|-------------|
| | SDO_E4 low | SDO_E4 high |
| Low | 19.44MHz | 17.408MHz |
| Float | 77.76MHz | N/A |
| High | 155.52MHz | 139.264MHz |
| CKSL[1:0] bits | E4 bit = 0 | E4 bit = 1 |
| 0 0 | 19.44MHz | 17.408MHz |
| 1 0 | 77.76MHz | N/A |
| 1 1 | 155.52MHz | 139.264MHz |

RECEIVER OPERATION

The receiver accepts serial data, at 155.52Mbps or 139.264Mbps from the RXP/N inputs. In CMI mode, the input is differentially terminated with 75Ω and transformer-coupled to a coaxial connector. In Fiber (NRZ) mode, the input is differentially terminated with 100Ω and AC-coupled to an optical transceiver module. For board designs utilizing both coax and fiber media options, an analog switch or mechanical relay is required to switch between the different terminations and media paths.

The recovered CMI signal first enters an AGC and an adaptive equalizer designed to overcome inter-symbol interference caused by long cable lengths. The variable gain differential amplifier automatically controls the gain to maintain a constant voltage level output regardless of the input voltage level. Note that in Fiber (NRZ) mode, the input signals bypass the adaptive equalizer.

The outputs of the data comparators are connected to the clock recovery circuits. The clock recovery system employs a Delay Locked Loop (DLL), which uses a reference frequency derived from the clock applied to the CKREFP/N pins.

In serial mode, the clock and data are decoded and transmitted through the LVPECL drivers. In parallel mode, the data is decoded and converted into four bit parallel segments before being transmitted through the CMOS drivers. Note that in Fiber (NRZ) mode, the CMI decoder is bypassed.

Receiver Monitor Mode

In CMI mode, the SCK_MON pin or MON register bit enables the receiver's monitor mode which adds approximately 20dB of **flat gain** to the receive signal before equalization. Rx Monitor Mode can handle 20dB of flat loss typical of monitoring points with up to 6dB of cable loss. Note that Loss of Signal detection is disabled during Rx Monitor Mode.

Receive Loss of Signal

The 78P2351 includes a Loss of Signal (LOS) detector. When the peak value of the received signal is less than approximately 19dB below nominal for approximately 110 UI, Receive Loss of Signal is asserted. The Rx LOS signal is cleared when the received signal is greater than approximately 18dB below nominal for 110 UI.

In ECL mode, the LOS signal will be asserted when there are no transitions for longer than 2.3µs. The signal is cleared when there are more than 4 transitions in 32 UI. It is generally recommended to use the LOS status signal from the optical transceiver module.

During Rx LOS conditions, the receive clock will remain on the last phase tap of the Rx DLL outputting a stable clock while the receive data outputs are squelched and held at logic '0'.

Note: Rx Loss of Signal detection is disabled during Local Loopback and Receive Monitor Modes.

Receive Loss of Lock

The 78P2351 includes an optional Receiver Loss of Lock detector that will flag if the recovered Rx clock frequency differs from the reference clock by more than ±100ppm in an interval greater than 420µs. This condition is cleared when the frequencies are less than ±100ppm off for more than 500µs.

Notes:

1. During Rx Loss of Signal (RLOS), the Rx Loss of Lock indicator is undefined and may report either status.
2. For reliable operation, the LOLOR bit in the Signal Control register should be toggled upon power-up and configuration.

TRANSMITTER OPERATION

At the media interface, the transmit driver generates an analog signal for transmission through either a transformer and 75Ω coaxial cable or directly to a fiber optics transceiver for electrical to optical conversion.

At the host interface, the 78P2351 provides a number interface options for compatibility with most off-the-shelf framers and custom ASICs. A selectable 4-bit parallel or nibble interface is available with both slave or master timing options as well a serial LVPECL interface with various timing recovery modes.

Each of the serial NRZ transmit timing modes can be configured in HW mode or SW mode as shown in the table below.

| Serial Mode | HW Control Pins | | SW Control Bit: | |
|--------------------------|-----------------|----------|-----------------|-----------|
| | SDI_PAR | CKMODE | PAR | SMOD[1:0] |
| Synchronous clock + data | Low | Low | 0 | 0 0 |
| Synchronous data only | Low | Floating | 0 | 1 0 |
| Plesiochronous data only | Low | High | 0 | 0 1 |
| Loop-timing | n/a | n/a | X | 1 1 |

Synchronous (Re-timing) Tx Serial Modes

In Figure 1, serial NRZ transmit data is input to the SIDP/N pins at LVPECL levels. By default, the data is latched in on the rising edge of SICKP. An integrated FIFO decouples the on chip and off chip clocks and re-clocks the data using a clean synthesized clock generated from the provided reference clock. As such, the SICKP/N clock provided by the framer/mapper IC must be source synchronous with the provided reference clock when the FIFO is to be used.

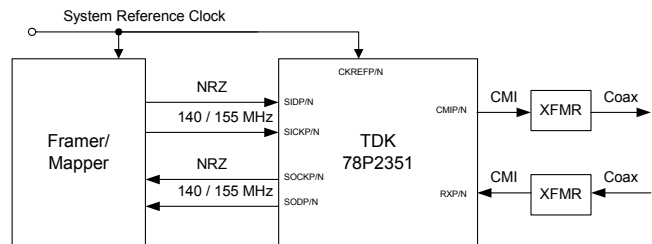

Figure 1: Synchronous clock and data available (Tx CDR bypassed, FIFO enabled)

If an off-chip serial transmit clock is not available, as in Figure 2, the 78P2351 can recover a Tx clock from the serial NRZ data input and pass the data through the clock decoupling FIFO. The data is then re-clocked or re-timed using a clean synthesized clock generated from the provided reference clock. In this mode, the NRZ transmit data must be source synchronous with the reference clock applied at CKREFP/N.

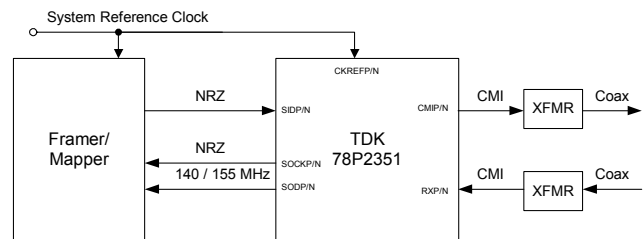

Figure 2: Synchronous data only (Tx CDR enabled, FIFO enabled)

Plesiochronous Tx Serial Mode

Figure 3 represents a common condition where a serial transmit clock is not available and/or the data is not source synchronous to the reference clock provided to the 78P2351. In this mode, the 78P2351 will recover a transmit clock from the serial plesiochronous data and bypass the internal FIFO and re-timing block. This mode is commonly used for mezzanine cards, modules, and any application where the reference clock can't always be synchronous to the transmit source clock/data.

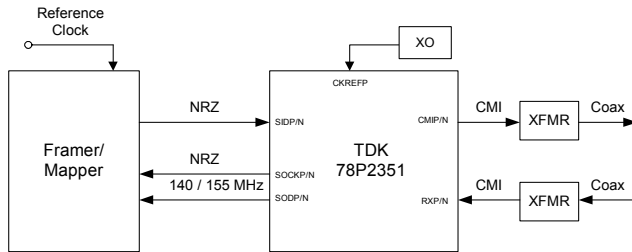

Figure 3: Plesiochronous data only (Tx CDR enabled, FIFO bypassed)

Synchronous Parallel Modes

In parallel modes, 4-bit CMOS data segments are input to the chip with a 34.816MHz (E4 ÷ 4) or 38.88MHz (STM1 ÷ 4) synchronous clock. These inputs are re-timed in a 4x8 clock decoupling FIFO and then to a serializer for transmission. Because the data is passed through the FIFO and re-timed using a synthesized clock, the transmit nibble clock and data must be source synchronous to the provided reference clock.

For maximum compatibility with legacy ASICs, the 78P2351 can operate in both slave and master clock modes as shown in Figures 4 and 5 respectively.

Note: A loop-timing mode is also available to allow external remote loopbacks (i.e. line loopback in framer). In this mode, the FIFO is still enabled, but the transmit data will be re-timed using the recovered receive clock.

| Parallel Mode | HW Control Pins | | SW Control Bits | |
|----------------------|-----------------|--------|-----------------|-------|
| | SDI_PAR | CKMODE | PAR | PMODE |
| Slave | High | Low | 1 | 0 |
| Slave + *Loop-timing | High | Float | 1 | 0 |
| Master | High | High | 1 | 1 |

*To enable loop-timing in software mode, set SMOD[1:0]=11

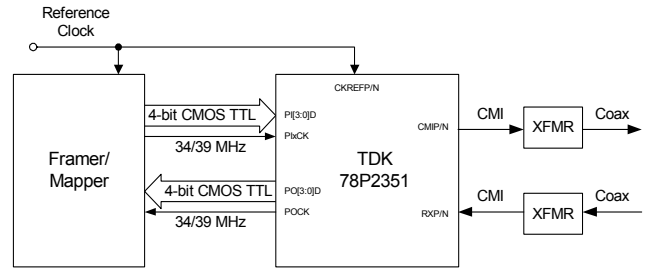

Figure 4: Slave Parallel Mode

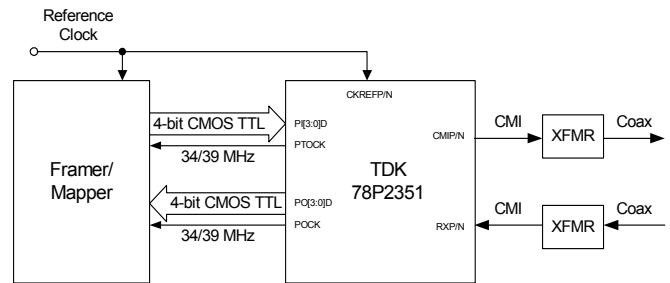

Figure 5: Master Parallel Mode

Transmit FIFO Description

Since the reference clock and transmit clock/data go through different delay paths, it is inevitable that the phase relationship between the two clocks can vary in a bounded manner due to the fact that the absolute delays in the two paths can vary over time. The transmit FIFO allows long-term clock phase drift between the Tx clock and system reference clock, not exceeding +/- 25.6ns, to be handled without transmit error. If the clock wander exceeds the specified limits, the FIFO will over or under flow, and the FERR register signal will be asserted. This signal can be used to trigger an interrupt. This interrupt event is automatically cleared when a FIFO Reset (FRST) pulse is applied, and the FIFO is re-centered.

Notes:

- 1) External remote loopbacks (i.e. loopback within framer) are not possible in synchronous operation (FIFO enabled) unless the data is re-justified to be synchronous to the system reference clock or the 78P2351 is configured for loop-timing operation.
- 2) During IC power-up or transmit power-up, the clocks going to the FIFO may not be stable and cause the FIFO to overflow or underflow. As such, the FIFO should be manually reset using FRST anytime the transmitter is powered-up.

Transmit Driver

In CMI (electrical) mode, the CMIP/N pins are biased and terminated off-chip. They interface to 75Ω coaxial cable through a 1:1 wideband transformer and coaxial RF connectors. Reference application notes for schematic and layout guidelines.

The transmitter encodes the data using CMI line coding and shapes an analog signal to meet the appropriate ITU-T G.703 template. The CMI outputs are tri-stated during transmit disable and transmit power-down for redundancy applications.

Note: To avoid reflections causing unwanted board noise, it's recommended to power-down unused transmit ports that are not terminated with cable to an Rx input port.

When the CMI pin is low, the chip is in Fiber (NRZ pass-through) mode and interfaces directly to an optical transceiver module. The ECLP/N pins are internally biased and output NRZ data at LVPECL levels. The CMI driver, encoder and decoder are disabled in Fiber (NRZ) mode.

Transmit Monitor Mode

An optional redundant transmit output is available in CMI mode for transmit monitoring. These outputs (CMI2P/N) are enabled when the RCSL pin or RCSL register bit is activated.

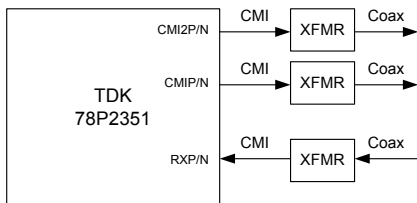

Figure 6: Transmit Monitor Output

Clock Synthesizer

The transmit clock synthesizer is a low-jitter DLL that generates a 278.528/311.04 MHz clock for the CMI encoder. It is also used in both the receive and transmit sides for clock and data recovery.

Note: This 2x line rate clock is also available at the TXCKxP/N pins for downstream synchronization or system debug.

Transmit Backplane Equalizer

An optional fixed LVPECL equalizer is integrated in the transmit path for architectures that use LIUs on active interface cards. The fixed equalizer can compensate for up to 1.5m of trace and can be enabled by the TXOUT1 pin or TXEQ bit as follows:

| TXOUT1 pin | TXEQ bit | Tx Equalizer |
|------------|----------|--------------|
| Low | 1 | Enabled |
| Float | 0 | Disabled |

Transmit Loss of Lock

In transmit modes using the integrated CDR, the 78P2351 will declare a loss of lock condition when there is no valid signal detected at the SIDP/N data inputs.

Note: The Tx LOL indicator is invalid and undefined when the parallel (nibble) interface is selected.

POWER-DOWN FUNCTION

Power-down control is provided to allow the 78P2351 to be shut off. Transmit and receive power-down can be set independently through SW control. Global power-down is achieved by powering down both the transmitter and receiver.

Note: The serial interface and configuration registers are not affected by power-down.

In HW mode, the transmitters can be powered down using the TXPD control pin.

LOOPBACK MODES

In SW mode, LLBK and RLBK bits in the Signal Control register are provided to activate the local and remote analog loopback modes respectively.

In HW mode, the LPBK pin can be used to activate local and remote analog loopback paths as shown in the table below.

| LPBK pin | Loopback Mode |
|----------|---|
| Low | Normal operation |
| Float | <u>Remote (analog) Loopback:</u> Recovered receive clock and data looped back directly to the transmit driver. The CMI decoder and most of transmit path is bypassed (including the redundant Tx monitor output) |
| High | <u>Local (analog) Loopback:</u> Transmit clock and data looped back to receiver at the analog media interface. |

In SW mode only, a Full Remote (digital) Loopback bit FLBK is also available in the Advanced Tx Control register. This loopback exercises the entire Rx and Tx paths of the 78P2351 including the Tx clock recovery unit. As such, the user must enable either Serial Plesiochronous or Serial Loop-timing transmit modes to utilize the Full Remote (digital) Loopback.

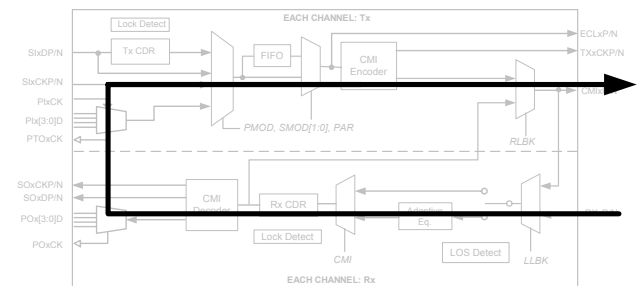

Figure 9: Remote (Digital) Loopback

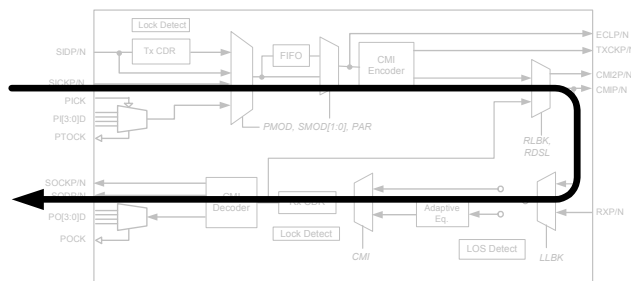

Figure 7: Local (Analog) Loopback

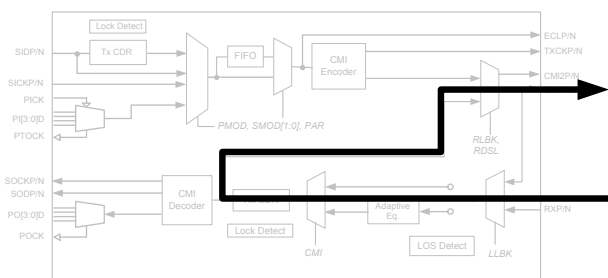

Figure 8: Remote (Analog) Loopback

INTERNAL POWER-ON RESET

Power-On Reset (POR) function is provided on chip. Roughly 50 μs after Vcc reaches 2.4V at power up, a reset pulse is internally generated. This resets all registers to their default values as well as all state machines within the transceiver to known initial values. The reset signal is also brought out to the PORB pin. The PORB pin is a special function analog pin that allows for the following:

- Override the internal POR signal by driving in an external active low reset signal;
- Use the internally generated POR signal to trigger other resets;
- Add external capacitor to slow down the release of power-on reset (approximately 8μs per nF added).

NOTE: Do not pull-up the PORB pin to Vcc or drive this pin high during power-up. This will prevent the internal reset generator from resetting the entire chip and may result in errors.

SERIAL CONTROL INTERFACE

The serial port controlled register allows a generic controller to interface with the 78P2351. It is used for mode settings, diagnostics and test, retrieval of status and performance information, and for on-chip fuse trimming during production test. The SPSL pin must be high in order to use the serial port.

The serial interface consists of four pins: Serial Port Enable (SEN_CMI), Serial Clock (SCK_MON), Serial Data In (SDI_PAR), and Serial Data Out (SDO_E4).

The SEN_CMI pin initiates the read and write operations. It can also be used to select a particular device allowing SCK_MON, SDI_PAR and SDO_E4 to be bussed together.

SCK_MON is the clock input that times the data on SDI_PAR and SDO_E4. Data on SDI_PAR is latched in on the rising-edge of SCK_MON, and data on SDO_E4 is clocked out using the falling edge of SCK_MON.

SDI_PAR is used to insert mode, address, and register data into the chip. Address and Data information are input least significant bit (LSB) first. The mode and address bit assignment and register table are shown in the following section.

SDO_E4 is a tri-state capable output. It is used to output register data during a read operation. SDO_E4 output is normally high impedance, and is enabled only during the duration when register data is being clocked out. Read data is clocked out least significant bit (LSB) first.

If SDI_PAR coming out of the micro-controller chip is also tri-state capable, SDI_PAR and SDO_E4 can be connected together to simplify connections.

PROGRAMMABLE INTERRUPTS

In addition to the receiver LOS and LOL status pins, the 78P2351 provides a programmable interrupt for the transmitter. In HW control mode, the default functions of the Tx interrupt is a transmit Loss of Lock (TXLOL) or FIFO error (FERR).

REGISTER DESCRIPTION

REGISTER ADDRESSING

| Address Bits | Bit 7 | Bit 6 | Bit 5 | Bit 4 | Bit 3 | Bit 2 | Bit 1 | Bit 0 |
|--------------|--------------|-------|-------|-------|-------------|-------|-------|----------------|
| | Port Address | | | | Sub-Address | | | Read/ Write |
| Assignment | PA[3] | PA[2] | PA[1] | PA[0] | SA[2] | SA[1] | SA[0] | R/W* |

REGISTER TABLE

a) PA[3:0] = 0 : Global Registers

| Sub Addr | Reg. Name | Description | Bit 7 | Bit 6 | Bit 5 | Bit 4 | Bit 3 | Bit 2 | Bit 1 | Bit 0 |
|----------|------------|-------------------|--------------|-----------|------------|----------------|----------------|-----------|--------------|--------------|
| 0 | MSCR (R/W) | Master Control | E4 <0> | -- <0> | PAR <0> | CKSL[1] <X> | CKSL[0] <X> | -- <X> | -- <X> | SRST <0> |
| 1 | INTC (R/W) | Interrupt Control | INPOL <0> | -- <0> | -- <1> | -- <0> | -- <0> | -- <X> | MTLOL <1> | MFERR <1> |
| 2 | IOCR (R/W) | I/O Control | -- <X> | -- <X> | -- <X> | -- <X> | -- <X> | -- <X> | -- <X> | RCSL <0> |

b) PA[3:0] = 1 : Port-Specific Registers

| Sub Addr | Reg. Name | Description | Bit 7 | Bit 6 | Bit 5 | Bit 4 | Bit 3 | Bit 2 | Bit 1 | Bit 0 |
|----------|------------|-----------------------|----------------|----------------|--------------|----------------|----------------|---------------|---------------|-------------|
| 0 | MDCR (R/W) | Mode Control | PDTX <0> | PDRX <0> | PMODE <X> | SMOD[1] <X> | SMOD[0] <X> | MON <0> | -- <0> | -- <1> |
| 1 | SGCR (R/W) | Signal Control | TCMIINV <0> | RCMIINV <0> | LOLOR <0> | RLBK <0> | LLBK <0> | RCLKP <0> | TCLKP <0> | FRST <0> |
| 2 | ACR1 (R/W) | Advanced Tx Control 1 | -- <0> | -- <0> | -- <0> | -- <0> | -- <0> | -- <0> | TPK <0> | TXEQ <0> |
| 3 | ACR0 (R/W) | Advanced Tx Control 0 | -- <1> | -- <0> | -- <1> | -- <0> | -- <1> | BST[1] <0> | BST[0] <0> | FLBK <0> |
| 4 | MCR2 (R/W) | Mode Control 2 | CMI <1> | -- <X> | -- <X> | -- <0> | -- <0> | -- <0> | -- <0> | -- <0> |
| 5 | STAT (R/C) | Status Monitor | -- <X> | -- <X> | -- <X> | RXLOS <X> | RXLOL <X> | -- <X> | TXLOL <X> | FERR <X> |
| 6-7 | -- | Reserved | -- | -- | -- | -- | -- | -- | -- | -- |

REGISTER DESCRIPTION (continued)

LEGEND

| TYPE | DESCRIPTION | TYPE | DESCRIPTION |
|------|----------------|------|---------------|
| R/O | Read only | R/W | Read or Write |
| R/C | Read and Clear | | |

GLOBAL REGISTERS

ADDRESS 0-0: MASTER CONTROL REGISTER

| BIT | NAME | TYPE | DFLT VALUE | DESCRIPTION |
|-----|------------|------|------------|---|
| 7 | E4 | R/W | 0 | Line Rate Selection: Selects the line rate as well as the input clock frequency at the CKREFP/N pins. 0: OC-3, STS-3, STM-1 (155.52MHz) 1: E4 (139.264MHz) |
| 6 | -- | R/W | 0 | Unused |
| 5 | PAR | R/W | 0 | Serial/Parallel Interface Selection: Selects the interface to the framer. 0: Serial LVPECL 1: 4-bit Parallel CMOS |
| 4:3 | CKSL [1:0] | R/W | XX | Reference Clock Frequency Selection: Selects the reference clock frequency input at CKREFP/N pins. 11: 155.52MHz / 139.264MHz (differential LVPECL) 10: 77.76MHz / NA (single-ended CMOS) 00: 19.44MHz / 17.408MHz (single-ended LVPECL) Secondary values correspond to E4 frequencies. Default values depend on the CKSL pin selection upon reset or power up. |
| 2:1 | -- | R/W | X0 | Reserved. |
| 0 | SRST | R/W | 0 | Register Soft-Reset: When this bit is set, all registers are reset to their default values. This register bit is self-clearing. |

REGISTER DESCRIPTION (continued)

ADDRESS 0-1: INTERRUPT CONTROL REGISTER

This register selects the events that would cause the interrupt pins to be activated. User may set as many bits as required.

| BIT | NAME | TYPE | DFLT VALUE | DESCRIPTION |
|-----|-------|------|------------|---|
| 7 | INPOL | R/W | 0 | Interrupt Pin Polarity Selection: 0 : Interrupt output is active-low (default) 1 : Interrupt output is active-high |
| 6:2 | -- | R/W | 01000 | Reserved for future use |
| 1 | MTLOL | R/W | 1 | TXLOL Error Mask (active low): Gates the TXLOL register bit to the INTTXB interrupt pin. 0: Mask 1: Pass |
| 0 | MFERR | R/W | 1 | FIERR Error Mask (active low): Gates the respective FIERR register bit to the INTTXB interrupt pin. 0: Mask 1: Pass |

ADDRESS 0-2: I/O CONTROL REGISTER

| BIT | NAME | TYPE | DFLT VALUE | DESCRIPTION |
|-----|------|------|------------|--|
| 7:1 | -- | R/W | XXXXXXXX | Unused |
| 0 | RCSL | R/W | 0 | Redundant Channel Enable: Enables transmit monitor outputs at CMI2P/N pins. 0: Disable 1: Enable |

REGISTER DESCRIPTION (continued)

PORT-SPECIFIC REGISTERS

For PA[3:0] = 1 only. Accessing a register with port address greater than 1 constitutes an invalid command.

ADDRESS 1-0: MODE CONTROL REGISTER

| BIT | NAME | TYPE | DFLT VALUE | DESCRIPTION |
|-----|---------|------|------------|---|
| 7 | PDTX | R/W | 0 | Transmitter Power-Down: 0 : Normal Operation 1 : Power-Down. CMI Transmit output is tri-stated. |
| 6 | PDRX | R/W | 0 | Receiver Power-Down: 0 : Normal Operation 1 : Power-Down |
| 5 | PMODE | R/W | X | Parallel Mode Interface Selection: When PAR=0 , PMODE is invalid and defaults to logic '1'; When PAR=1 , (Master Control Register: bit 5), PMODE selects the source of the transmit parallel clock, either taken from the framer externally or generated internally. Default value is determined by CKMODE pin setting upon power up or reset. 0: Slave Timing. PICK clock input to the transmitter 1: Master Timing. PTOCK clock output from the transmitter |
| 4 | SMOD[1] | R/W | X | Serial Mode Interface Selection: When PAR=0 (Master Control Register: bit 5), SMOD[1:0] configures the transmitter's system interface. Default values determined by CKMODE pin setting upon power up or reset. <u>SMOD[1] SMOD[0]</u> 0 0 <u>Synchronous clock and data</u> are passed through a FIFO. The CDR is bypassed. 1 0 <u>Synchronous data</u> is passed through the CDR and then through the FIFO. 0 1 <u>Plesiochronous data</u> is passed through the CDR to recover a clock. FIFO is bypassed because the data is not synchronous with the reference clock. 1 1 <u>Loop Timing Mode Enable</u> : The recovered receive clock is used as the reference for the transmit DLL and FIFO. |
| 3 | SMOD[0] | R/W | X | |
| 2 | MON | R/W | 0 | Receive Monitor Mode Enable: 0: Normal Operation 1: Adds 20dB of flat gain to the receive signal before equalization. NOTE: Monitor mode is only available in CMI mode. |
| 1:0 | -- | R/W | 00 | Reserved |

REGISTER DESCRIPTION (continued)

ADDRESS 1-1: SIGNAL CONTROL REGISTER

| BIT | NAME | TYPE | DFLT VALUE | DESCRIPTION | | | | | | | | | | | | |
|-------------|-------------|---|------------|--|-------------|-------------|--|---|---|------------------|---|---|---|---|---|---|
| 7 | TCMIINV | R/W | 0 | Transmit CMI Inversion: This bit will flip the polarity of the transmit CMI data outputs at CMIP/N. For debug use only. 0: Normal 1: Invert | | | | | | | | | | | | |
| 6 | RCMIINV | R/W | 0 | Receive CMI Inversion: This bit will flip the polarity of the receive CMI data inputs at RXP/N. For debug use only. 0: Normal 1: Invert | | | | | | | | | | | | |
| 5 | LOLOR | R/W | 0 | Receive Loss of Lock/Signal Override: When high, the RXLOL and RXLOS signals will always remain low. 0: Normal 1: Forces LOS and LOL outputs to be low and resets counters NOTE: For reliable operation of the Rx LOL detection circuitry, one must manually reset the LOL counter by toggling this bit upon power-up or initialization. | | | | | | | | | | | | |
| 4 | RLBK | R/W | 0 | Analog Loopback Selection: <table border="0"> <tr> <td><u>RLBK</u></td> <td><u>LLBK</u></td> <td></td> </tr> <tr> <td>0</td> <td>0</td> <td>Normal operation</td> </tr> <tr> <td>1</td> <td>0</td> <td><u>Remote Loopback Enable:</u> Recovered receive data is looped back to the transmit driver</td> </tr> <tr> <td>0</td> <td>1</td> <td><u>Local Loopback Enable:</u> The transmit data is looped back and used as the input to the receiver.</td> </tr> </table> | <u>RLBK</u> | <u>LLBK</u> | | 0 | 0 | Normal operation | 1 | 0 | <u>Remote Loopback Enable:</u> Recovered receive data is looped back to the transmit driver | 0 | 1 | <u>Local Loopback Enable:</u> The transmit data is looped back and used as the input to the receiver. |
| <u>RLBK</u> | <u>LLBK</u> | | | | | | | | | | | | | | | |
| 0 | 0 | Normal operation | | | | | | | | | | | | | | |
| 1 | 0 | <u>Remote Loopback Enable:</u> Recovered receive data is looped back to the transmit driver | | | | | | | | | | | | | | |
| 0 | 1 | <u>Local Loopback Enable:</u> The transmit data is looped back and used as the input to the receiver. | | | | | | | | | | | | | | |
| 3 | LLBK | R/W | 0 | | | | | | | | | | | | | |
| 2 | RCLKP | R/W | 0 | Receive Clock Inversion Select: This bit will invert the receive output clock. 0: <u>Normal.</u> Data clocked out on falling edge of receive clock. 1: <u>Invert.</u> Data clocked out on the rising edge of receive clock. | | | | | | | | | | | | |
| 1 | TCLKP | R/W | 0 | Transmit Clock Inversion Select: This bit will invert the transmit input system clock. 0: <u>Normal.</u> Data is clocked in on rising edge of the transmit clock. 1: <u>Invert.</u> Data is clocked in on the falling edge of the transmit clock. | | | | | | | | | | | | |
| 0 | FRST | R/W | 0 | FIFO Reset: 0: Normal operation 1: Reset FIFO pointers to default locations. This reset should be initiated anytime the transmitter or IC powers up to ensure the FIFO is centered after internal VCO clocks and external transmit clocks are stable. NOTES: Transmit monitor port will also be affected by FRST, FIFO resets not required for Plesiochronous Serial Mode | | | | | | | | | | | | |

REGISTER DESCRIPTION (continued)

ADDRESS 1-2: ADVANCED TRANSMIT CONTROL REGISTER 1

| BIT | NAME | TYPE | DFLT VALUE | DESCRIPTION |
|-----|------|------|------------|--|
| 7:1 | -- | R/W | 0000000 | Reserved. |
| 0 | TXEQ | R/W | 0 | Transmit Fixed Equalizer Enable: When enabled, compensates for between 0.75m and 1.5m of FR4 trace to the serial LVPECL data inputs SIDP/N 0: Normal Operation 1: Enable equalizer |

ADDRESS 1-3: ADVANCED TRANSMIT CONTROL REGISTER 0

| BIT | NAME | TYPE | DFLT VALUE | DESCRIPTION |
|-----|----------|------|------------|---|
| 7:3 | -- | R/W | 10101 | Reserved. |
| 2:1 | BST[1:0] | R/W | 00 | Transmit Driver Amplitude Boost: Adds roughly 5% or 10% of boost to the CMI output. Limits not tested during production test. 00 : Normal amplitude 01 : 5% boost 10 : Reserved 11 : 10% boost |
| 0 | FLBK | R/W | 0 | Full Remote (digital) Loopback Enable: When enabled the recovered receive data is decoded and looped back to the transmit clock recovery unit exercising the entire receive and transmit paths. NOTE: Must be used in conjunction with Serial Plesiochronous Mode or Serial Loop-Timing Mode. |

ADDRESS 1-4: MODE CONTROL REGISTER 2

| BIT | NAME | TYPE | DFLT VALUE | DESCRIPTION |
|-----|------|------|------------|--|
| 7 | CMI | R/W | 1 | Line Interface Mode Selection: 0: Optical fiber (LVPECL, NRZ). CMI ENDEC and line driver are disabled. Use RXP/N and ECLP/N pins for line interface. 1: Coaxial cable (CMI encoded). CMI ENDEC enabled. Optical (NRZ) interface disabled. Use RXP/N and CMIP/N pins for line interface. |
| 6:0 | -- | R/W | XX00000 | Reserved. |

REGISTER DESCRIPTION (continued)

ADDRESS 1-5: STATUS MONITOR REGISTER

| BIT | NAME | TYPE | DFLT VALUE | DESCRIPTION |
|-----|-------|------|------------|---|
| 7:5 | -- | R/C | XXX | Reserved. |
| 4 | RXLOS | R/C | X | Receive Loss of Signal Indication: 0: Normal operation 1: Loss of signal condition detected |
| 3 | RXL0L | R/C | X | Receive Loss of Lock Indication: This status bit is only defined during a valid input signal at RP/N or when RXLOS=0 0: Normal operation 1: Recovered receive clock frequency differs from the reference by more than +/- 100ppm. |
| 2 | -- | R/C | X | Unused |
| 1 | TXL0L | R/C | X | Transmit Loss of Lock Indication: This status bit is only defined and valid when using one of the serial transmit modes utilizing the Tx CDR. 0: Valid transmit input signal detected at SIDP/N 1: No valid signal detected at SIDP/N |
| 0 | FERR | R/C | X | Transmit FIFO Error Indication: This bit is set whenever the internal FERR signal is asserted, indicating that the FIFO is operating at its depth limit. It is reset to 0 when the FRST pin is asserted. 0: Normal operation 1: Transmit FIFO phase error |

ADDRESS 1-6, 1-7: RESERVED

| BIT | NAME | TYPE | DFLT VALUE | DESCRIPTION |
|-----|------|------|------------|--------------------|
| 7:0 | RSVD | R/O | 0 | Reserved for test. |

PIN DESCRIPTION

LEGEND

| TYPE | DESCRIPTION | TYPE | DESCRIPTION |
|------|---|------|--|
| A | Analog Pin (Tie unused pins to ground) | PO | LVPECL-Compatible Differential Output (Tie unused pins to supply or leave floating) |
| CIS | CMOS Schmitt Trigger Input (Tie unused pins to ground) | CO | CMOS Digital Output (Leave unused pins floating) |
| CI | CMOS Digital Input (Tie unused pins to ground) | COZ | CMOS Tristate Digital Output (Leave unused pins floating) |
| CIU | CMOS Digital Input w/ Pull-up | OD | Open-drain Digital Output (Leave unused pins floating) |
| CID | CMOS Digital Input w/ Pull-down | S | Supply |
| CIT | 3-State CMOS Digital Input | G | Ground |
| PI | LVPECL-Compatible Differential Input (Tie unused pins to ground) | | |

TRANSMITTER PINS

| NAME | PIN | TYPE | DESCRIPTION |
|------------------------------|----------------------|------|---|
| PI0D PI1D PI2D PI3D | 24 25 26 27 | CI | Transmit (Parallel Mode) Data Input: Four-bit CMOS parallel (nibble) inputs. Data is latched in on the rising edge (default) of the transmit parallel clock and serialized with the MSB (PIx3D) transmitted first. |
| PICK | 23 | CIS | Transmit (Parallel Mode) Clock Input: A 34.816 MHz (E4) or 38.88 MHz (STM1) CMOS clock input that must be source synchronous with the reference clock supplied at the CKREFP/N pins. Used only in Slave Parallel Mode and Loop-timing Parallel Mode. |
| PTOCK | 28 | CO | Transmit (Parallel Mode) Clock Output: A 34.816 MHz (E4) or 38.88 MHz (STM1) CMOS clock output that is intended to latch in synchronous parallel data. Active during reset. Used only in Master Parallel Mode (output disabled in all other transmit modes). |
| SIDP SIDN | 8 9 | PI | Transmit (Serial Mode) Data Input: Differential NRZ data input. See <i>Transmitter Operation</i> section for more info on different clocking/timing modes. |
| SICKP SICKN | 5 6 | PI | Transmit (Serial Mode) Clock Input: A 155.52MHz synchronous differential input clock used to clock in the serial NRZ data. By default, data is clocked in on the rising edge of SICKP. |
| CMIP CMIN | 93 94 | A | Transmit (CMI Mode) Analog Data Output: A CMI encoded data signal output conforming to the relevant ITU-T G.703 pulse templates when properly terminated and transformer coupled to 75Ω cable. Outputs are tri-stated when transmitter is disabled. Active, but undefined during reset. |
| CMI2P CMI2N | 79 78 | A | Transmit Monitor Output: Redundant CMI transmit driver enabled by RCSL control. |
| TXCKP TXCKN | 96 97 | PO | Transmit (Serial Mode) Clock Output: A 2x line rate LVPECL clock output used to clock out the transmit CMI data. Used for diagnostics or far end re-timing. Active during reset. |
| ECLP ECLN | 99 100 | PO | Transmit (Optical Mode) LVPECL Data Output: Transmit data outputs used for interfacing with optical transceiver modules when in Fiber (NRZ pass through) mode. |

PIN DESCRIPTION (continued)

RECEIVER PINS

| NAME | PIN | TYPE | DESCRIPTION |
|------------------------------|----------------------|----------|---|
| PO0D PO1D PO2D PO3D | 41 40 37 36 | CO | Receive Data (Parallel Mode) Output: Recovered receive data de-serialized into four-bit CMOS parallel (nibble) outputs. The MSB (PO3D) is received first. Active, but undefined during reset. <u>Note:</u> During Loss of Signal conditions, data outputs are held low. |
| POCK | 33 | CO | Receive (Parallel Mode) Clock Output: A 34.816 MHz (E4) or 38.88 MHz (STM1) CMOS clock output generated by dividing down the recovered receive clock. By default, receive data is clocked out on the falling edge. Active during reset. <u>Note:</u> During Loss of Signal conditions, the clock will remain on the last divided down phase selection of the Rx DLL and output a steady clock. |
| SODP SODN | 20 21 | PO | Receive (Serial Mode) Data Output: Recovered receive serial NRZ data at LVPECL levels. Active, but undefined during reset. <u>Note:</u> During Loss of Signal conditions, data outputs are held at logic 0. |
| SOCKP SOCKN | 18 19 | PO | Receive (Serial Mode) Clock Output: Recovered receive serial clock. By default, recovered serial NRZ data is clocked out the falling edge of SOCKP. Active during reset. <u>Note:</u> During Loss of Signal conditions, the clock will remain on the last phase selection of the Rx DLL and output a steady clock. |
| RXP RXN | 90 91 | A/ PI | Receiver (CMI or NRZ) Input: The input is either transformer-coupled to coaxial cable for CMI data or AC-coupled at LVPECL levels to an optical transceiver module for NRZ data. |

PIN DESCRIPTION (continued)

REFERENCE AND STATUS PINS

| NAME | PIN | TYPE | DESCRIPTION |
|------------------|----------|-----------|---|
| CKREFP CKREFN | 83 82 | PI/ CI | Reference Clock Input: A required reference clock input used for clock/data recovery and frequency synthesizer. Options include <ul style="list-style-type: none"> • 139.264 MHz (E4) or 155.52 MHz (STM1) differential LVPECL clock input at CKREFP/N • 17.408 MHz (E4), 19.44 MHz (STM1), or 77.78 MHz (STM1) single-ended CMOS clock input at CKREFP. Tie CKREFN to ground when unused. |
| LOS | 61 | OD | Receive Loss of Signal (active-high): See Receiver Loss of Signal description for conditions. |
| LOL | 60 | OD | Receive Loss of Lock (active-high): This condition is met when the recovered clock frequency differs from the reference clock frequency by more than +/- 100ppm. |
| INTTXB | 67 | OD | Transmitter Fault Interrupt Flag (active low): When a transmitter error event occurs (as defined in the Interrupt Control Register Description), the INTTXB pin will change state to indicate an interrupt. The interrupt is cleared by a read to the STAT Register, an issue of a FRST FIFO reset pulse (if the FIERR signal caused the interrupt), or when the TXLOL register bit transitions from high to low. <u>Note:</u> The default interrupt condition is a loss of lock in the transmitter CDR. |
| INTRXB | 52 | OD | Receiver Fault Interrupt Flag (active-low): Reserved for future use. |
| PORB | 64 | A | Power-On Reset (active-low): See Power-On Reset description on use of this pin. |

PIN DESCRIPTION (continued)

CONTROL PINS

| NAME | PIN | TYPE | DESCRIPTION |
|--------|-----|------|--|
| FRST | 59 | CIT | <p>FIFO Phase-Initialization Control:</p> <p>When asserted, the transmit FIFO pointers are reset to the respective “centered” states. Also resets the FIERR interrupt bit. De-assertion edge of FRST will resume FIFO operation.</p> <ul style="list-style-type: none"> • <u>Low</u>: FRST assertion. • <u>Float/High</u>: Normal <p>Because the internal VCO clock and off-chip transmit clocks may not be stable during transmit power-up, it is recommended to always reset the FIFOs after powering up the IC or the transmitter.</p> <p>Not valid during Plesiochronous Serial Mode.</p> |
| RCSL | 14 | CID | <p>Redundant Channel Selection:</p> <p>Enables the redundant Transmit Monitor Output at pins CMI2P/N.</p> <ul style="list-style-type: none"> • <u>Low</u>: Normal operation (CMIP/N active only) • <u>High</u>: Transmit Monitor Mode (CMIP/N and CMI2P/N active) |
| LPBK | 15 | CIT | <p>Analog Loopback Selection:</p> <ul style="list-style-type: none"> • <u>Low</u>: Normal operation • <u>Float</u>: Remote Loopback Enable: Recovered receive data and clock are looped back to the transmitter for retransmission. • <u>High</u>: Local Loopback Enable: The serial transmit data is looped back and used as the input to the receiver. |
| CKMODE | 13 | CIT | <p>Clock Mode Selection:</p> <p>Selects the method of inputting transmit data into the chip. See TRANSMITTER OPERATION section for more information.</p> <p>In PARALLEL mode (SDI_PAR high):</p> <ul style="list-style-type: none"> • <u>Low</u>: Parallel transmit clock is input to the 78P2351. • <u>Float</u>: Parallel transmit clock is input to the 78P2351. Loop-timing mode enabled. • <u>High</u>: Parallel transmit clock is output from the 78P2351 <p>In SERIAL mode (SDI_PAR low):</p> <ul style="list-style-type: none"> • <u>Low</u>: Reference clock is synchronous to transmit clock and data. Data is clocked in with SICKP/N and passed through a FIFO • <u>Float</u>: Reference clock is synchronous to transmit data. Clock is recovered with a CDR and data is passed through a FIFO • <u>High</u>: Reference clock is plesiochronous to transmit data. Clock is recovered with a CDR and the FIFO is bypassed |

PIN DESCRIPTION (continued)

CONTROL PINS (continued)

| NAME | PIN | TYPE | DESCRIPTION |
|--------|-----|------|--|
| TXOUT1 | 1 | CIT | Advanced Tx Control 1: <u>Low:</u> Enables fixed LVPECL equalizer at the transmit inputs SIDP/N for FR4 trace lengths up to 1.5m. <u>Float:</u> Normal operation <u>High:</u> Normal operation |
| TXOUT0 | 2 | CIT | Advanced Tx Control 0: <u>Low:</u> Nominal amplitude <u>Float:</u> 5% amplitude boost <u>High:</u> 10% amplitude boost |
| TXPD | 12 | CID | Transmitter Power Down: When high, powers down and tri-states the transmit driver. The transmit monitor port, if enabled, is also powered down when TXPD is high. |
| SPSL | 58 | CID | Serial Port Selection: When high, chip is software controlled through the serial port. |
| CKSL | 62 | CIT | Reference Clock Frequency Selection: Selects the reference frequency that is supplied at the CKREFP/N pins. Its level is read in only at power-up or on the rising edge of a reset signal at the PORB pin. <ul style="list-style-type: none"> • <u>Low:</u> 19.44MHz or 17.408MHz • <u>Float:</u> 77.76MHz • <u>High:</u> 155.52MHz or 139.264MHz |

PIN DESCRIPTION (continued)

SERIAL-PORT PINS

| NAME | PIN | TYPE | DESCRIPTION |
|---------|-----|------------|---|
| SEN_CMI | 72 | CIU | <p>[SPSL=1] Serial-Port Enable: High during read and write operations. Low disables the serial port. While SEN is low, SDO remains in high impedance state, and SDI and SCK activities are ignored.</p> <p>[SPSL=0] Medium Select: Low: Fiber (NRZ pass-through) mode High: CMI mode</p> |
| SCK_MON | 73 | CIS | <p>[SPSL=1] Serial Clock: Controls the timing of SDI and SDO.</p> <p>[SPSL=0] Receive Monitor Mode Enable: When high, adds 20dB of flat gain to the incoming signal before equalization. Rx Monitor mode is only available in CMI mode.</p> |
| SDI_PAR | 71 | CI | <p>[SPSL=1] Serial Data Input: Inputs mode and address information. Also inputs register data during a Write operation. Both address and data are input least significant bit first.</p> <p>[SPSL=0] Data Width Select: Selects 4 bit parallel transmit modes (input high) or serial transmit modes (input low)</p> |
| SDO_E4 | 70 | COZ/ CI | <p>[SPSL=1] Serial Data Output: Outputs register information during a Read operation. Data is output least significant bit first</p> <p>[SPSL=0] Rate Select: Selects E4 operation (input high) or STM1/STS3 operation (input low)</p> |

POWER AND GROUND PINS

It is recommended that all supply pins be connected to a single power supply plane and all ground pins be connected to a single ground plane. See application note for decoupling guidelines.

| NAME | PIN | TYPE | DESCRIPTION |
|------|---|------|---|
| VCC | 3, 10, 16, 56, 66, 69, 76, 80, 88, 92, 98 | S | Power Supply |
| VDD | 31, 35, 39, 43 | S | CMOS I/O Driver Supply |
| GND | 4, 11, 17, 55, 65, 68, 77, 84, 85, 86, 87, 89, 95 | G | Ground |
| VSS | 30, 34, 38, 42 | G | CMOS I/O Driver Ground |
| TGND | 63 | G | Trim Ground Used during production test. Connect directly to ground. Do not decouple to supply or PORB. |

ELECTRICAL SPECIFICATIONS

ABSOLUTE MAXIMUM RATINGS

Operation beyond these limits may permanently damage the device.

| PARAMETER | RATING |
|------------------------------|-----------------------|
| Supply Voltage (Vdd) | -0.5 to 4.0 VDC |
| Storage Temperature | -65 to 150 °C |
| Junction Temperature | -40 to 150 °C |
| Pin Voltage (CMIxP, CMIxN) | Vdd + 1.5 VDC |
| Pin Voltage (all other pins) | -0.3 to (Vdd+0.6) VDC |
| Pin Current | ±100 mA |

RECOMMENDED OPERATING CONDITIONS

Unless otherwise noted all specifications are valid over these temperatures and supply voltage ranges.

| PARAMETER | RATING |
|-------------------------------|------------------|
| DC Voltage Supply (Vdd) | 3.15 to 3.45 VDC |
| Ambient Operating Temperature | -40 to 85 °C |
| Junction Temperature | -40 to 125 °C |

DC CHARACTERISTICS:

| PARAMETER | SYMBOL | CONDITIONS | MIN | NOM | MAX | UNIT |
|--|--------|--|-----|-----|-----|------|
| Supply Current (CMI) (including transmitter current through transformer) | Iddm | STM-1 mode; CMI mode; Max. cable length; Tx Monitor <u>Enabled</u> | | 190 | 212 | mA |
| | Idd | STM-1 mode; CMI mode; Max. cable length; Tx Monitor <u>Disabled</u> | | 160 | 180 | mA |
| Supply Current (NRZ) | Idde | STM-1 mode; NRZ (optical) mode; | | 145 | 160 | mA |
| Receive-only Supply Current | Iddr | Transmitter disabled; STM-1 mode; CMI mode; Max. cable length; | | 92 | 106 | mA |
| Power down Current | Iddq | PDTX=1, PDRX=1 | | 7 | 10 | mA |

ELECTRICAL SPECIFICATIONS (continued)

ANALOG PINS CHARACTERISTICS:

The following table is provided for informative purpose only. Not tested in production.

| PARAMETER | SYMBOL | CONDITIONS | MIN | NOM | MAX | UNIT |
|--|--------|------------------|-----|-----|-----|------|
| RXP and RXN Common-Mode Bias Voltage | Vblin | Ground Reference | 1.9 | 2.1 | 2.6 | V |
| RXP and RXN Differential Input Impedance | Rilin | | | 20 | | kΩ |
| Analog Input/Output Capacitance | Cin | | | 8 | | PF |
| PORB Input Impedance | -- | | | 5 | | kΩ |

DIGITAL I/O CHARACTERISTICS:

Pins of type CI, CIU, CID:

| PARAMETER | SYMBOL | CONDITIONS | MIN | NOM | MAX | UNIT |
|----------------------|----------|-------------------|-----|-----|-----|------|
| Input Voltage Low | Vil | Type CI, CID only | | | 0.8 | V |
| | | Type CIU only | | | 0.4 | |
| Input Voltage High | Vih | | 2.0 | | | V |
| Input Current | Iil, Iih | | -1 | 0 | 1 | μA |
| Pull-up Resistance | Rpu | Type CIU only | 53 | 70 | 113 | kΩ |
| Pull-down Resistance | Rpd | Type CID only | 40 | 58 | 120 | kΩ |
| Input Capacitance | Cin | | | 8 | | pF |

Pins of type CIT :

| PARAMETER | SYMBOL | CONDITIONS | MIN | NOM | MAX | UNIT |
|---|--------|------------|---------|-----|-----|------|
| Input Voltage Low | Vtil | | | | 0.4 | V |
| Input Voltage High | Vtih | | Vcc-0.6 | | | V |
| Minimum impedance to be considered as "float" state | Rtiz | | 30 | | | kΩ |

Pins of type CIS:

| PARAMETER | SYMBOL | CONDITIONS | MIN | NOM | MAX | UNIT |
|-----------------------|----------|------------|-----|-----|-----|------|
| Low-to-High Threshold | Vt+ | | 1.3 | | 1.7 | V |
| High-to-Low Threshold | Vt- | | 0.8 | | 1.2 | V |
| Input Current | Iil, Iih | | -1 | | 1 | μA |
| Input Capacitance | Cin | | | 8 | | pF |

ELECTRICAL SPECIFICATIONS (continued)

Pins of type CO and COZ:

| PARAMETER | SYMBOL | CONDITIONS | MIN | NOM | MAX | UNIT |
|----------------------------------|------------------|------------------------|-----|-----|-----|------|
| Output Voltage Low | V _{ol} | I _{ol} = 8mA | | | 0.4 | V |
| Output Voltage High | V _{oh} | I _{oh} = -8mA | 2.4 | | | V |
| Output Transition Time | T _t | C _L = 20pF | | | 2 | ns |
| Effective Source Impedance | R _{scr} | | | 30 | | Ω |
| Tri-state Output Leakage Current | I _z | Type COZ only | -1 | | 1 | μA |

Pins of type PO:

| PARAMETER | SYMBOL | CONDITIONS | MIN | NOM | MAX | UNIT |
|----------------------------|------------------|----------------------------|-------|------|------|------|
| Signal Swing | V _{pk} | | 0.5 | 0.8 | 1.1 | V |
| | | TXxCKP/N pins | 0.35 | | 0.95 | |
| Common Mode Level | V _{cm} | V _{dd} referenced | -1.55 | -1.2 | -1.1 | V |
| Effective Source Impedance | R _{eff} | | | 20 | | Ω |
| Rise Time | T _r | 10-90% | | 0.8 | 1.2 | ns |
| Fall Time | T _f | 10-90% | | 0.8 | 1.2 | ns |

Pins of type PI:

| PARAMETER | SYMBOL | CONDITIONS | MIN | NOM | MAX | UNIT |
|-------------------|------------------|----------------------------|------|------|------|------|
| Signal Swing | V _{pki} | | 0.3 | | | V |
| Common Mode Level | V _{cm} | V _{dd} referenced | -1.6 | -1.2 | -0.8 | V |

Pins of type OD

| PARAMETER | SYMBOL | CONDITIONS | MIN | NOM | MAX | UNIT |
|---------------------------|-----------------|-----------------------|-----|-----|-----|------|
| Output Voltage Low | V _{ol} | I _{ol} = 8mA | | | 0.4 | V |
| Pull-down Leakage Current | I _{pd} | Logic high output | | | 1 | μA |
| Pull-up Resistor | R _{pu} | | 4.7 | | 10 | kΩ |

ELECTRICAL SPECIFICATIONS (continued)

SERIAL-PORT TIMING CHARACTERISTICS:

| PARAMETER | SYMBOL | CONDITIONS | MIN | TYP | MAX | UNIT |
|------------------------------|------------|------------|-----|-----|-----|------|
| SDI to SCK setup time | t_{su} | | 4 | | | ns |
| SDI to SCK hold time | t_h | | 4 | | | ns |
| SCK to SDO propagation delay | t_{prop} | | | | 10 | ns |
| SCK frequency | SCK | | | | 20 | MHz |

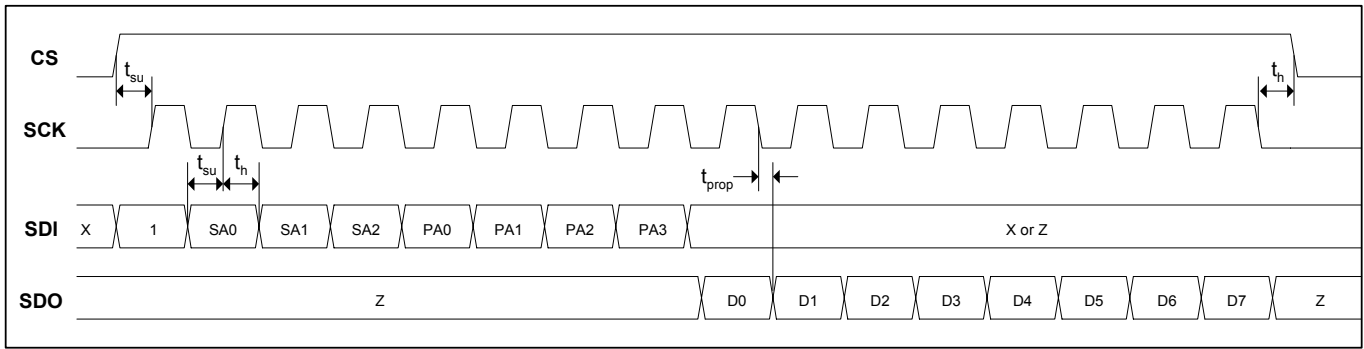

Figure 10: Read Operation

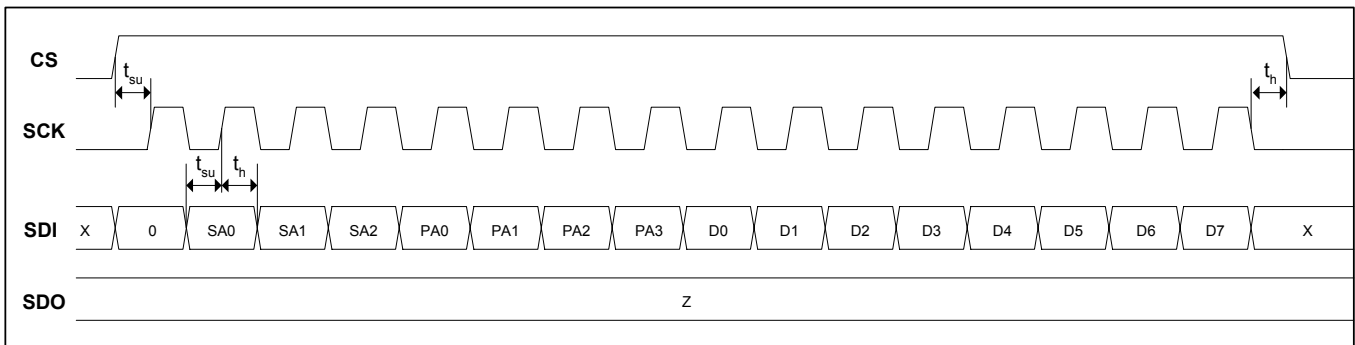
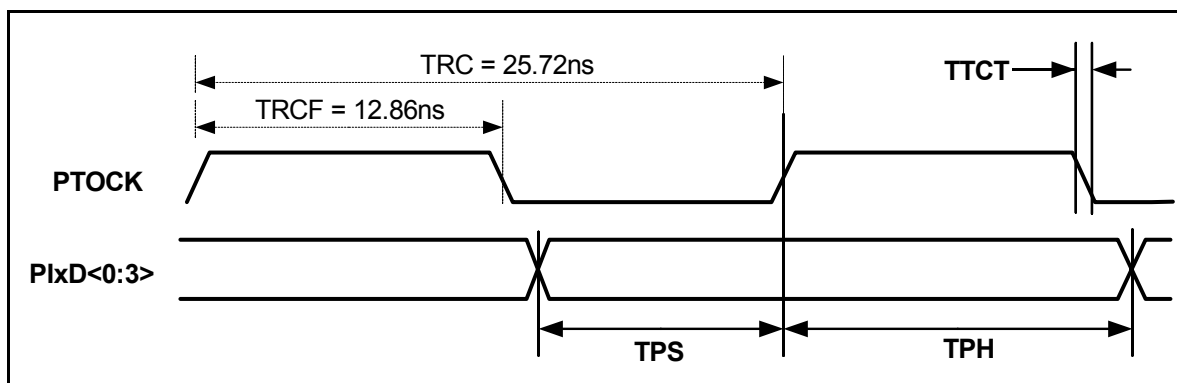
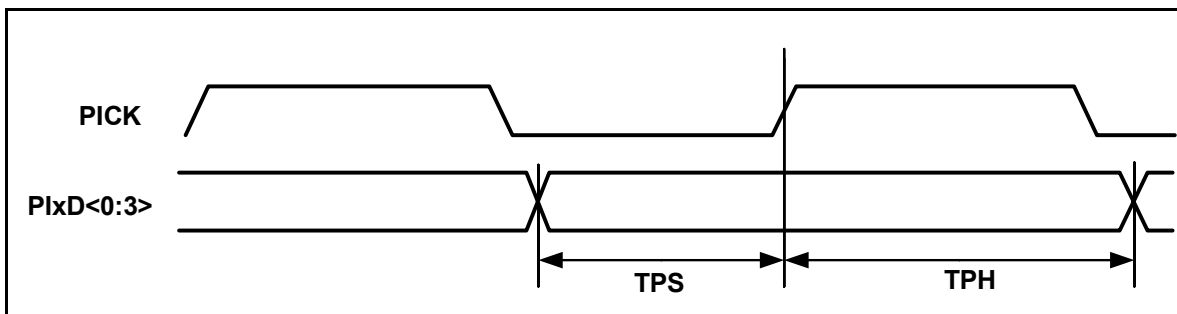
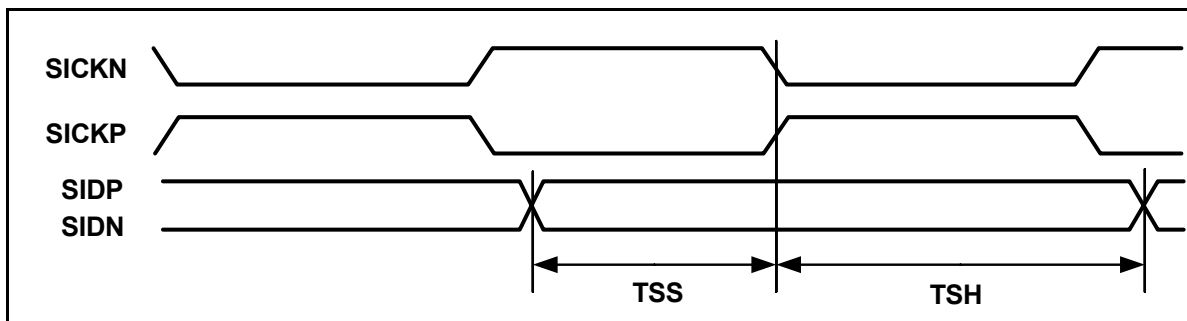

Figure 11: Write Operation

ELECTRICAL SPECIFICATIONS (continued)

TRANSMITTER TIMING CHARACTERISTICS:

| PARAMETER | SYMBOL | CONDITIONS | MIN | NOM | MAX | UNIT |
|------------------|----------|---------------|-----|-----|-----|------|
| Clock Duty Cycle | TTCF/TTC | PTOCK | 40 | | 60 | % |
| Setup Time | TPS | Parallel mode | 4 | | | ns |
| Hold Time | TPH | Parallel mode | 4 | | | ns |
| Setup Time | TSS | Serial mode | 2 | | | ns |
| Hold Time | TSH | Serial mode | 2 | | | ns |

TIMING DIAGRAM: Transmitter Waveforms

ELECTRICAL SPECIFICATIONS (continued)

REFERENCE CLOCK CHARACTERISTICS:

| PARAMETER | SYMBOL | CONDITIONS | MIN | NOM | MAX | UNIT |
|---------------------------|--------|--|-----|-----|-----|------|
| CKREF Duty Cycle | -- | | 40 | | 60 | % |
| CKREF Frequency Stability | -- | Synchronous mode; E4 | -15 | | +15 | ppm |
| | | Synchronous mode; STM1 | -20 | | +20 | |
| | | Plesiochronous or Loop-timing mode. (see Note 1) | -75 | | +75 | |

Note 1: In Plesiochronous mode, the transmit clock/data source (i.e. framer/system reference clock) must still be of +/-20ppm quality (+/-15ppm for E4) in order to meet the ITU-T (or Telcordia) bit rate requirements.

RECEIVER TIMING CHARACTERISTICS:

| PARAMETER | SYMBOL | CONDITIONS | MIN | NOM | MAX | UNIT |
|-----------------|----------|---------------|-----|-----|-----|------|
| RCLK Duty Cycle | TRCF/TRC | | 40 | | 60 | % |
| Clock to Q | RSCQ | Serial mode | 0 | | 1 | ns |
| | RPCQ | Parallel mode | -1 | | 2 | |

TIMING DIAGRAM: Receive Waveforms

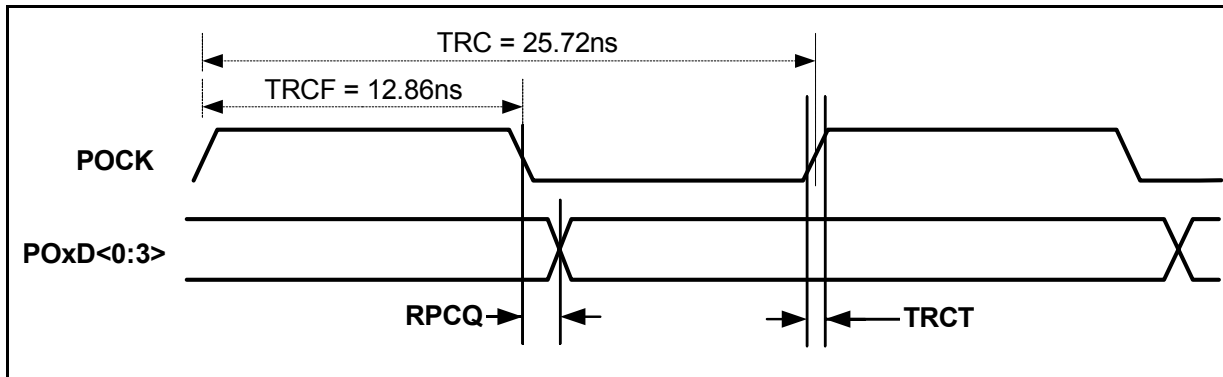
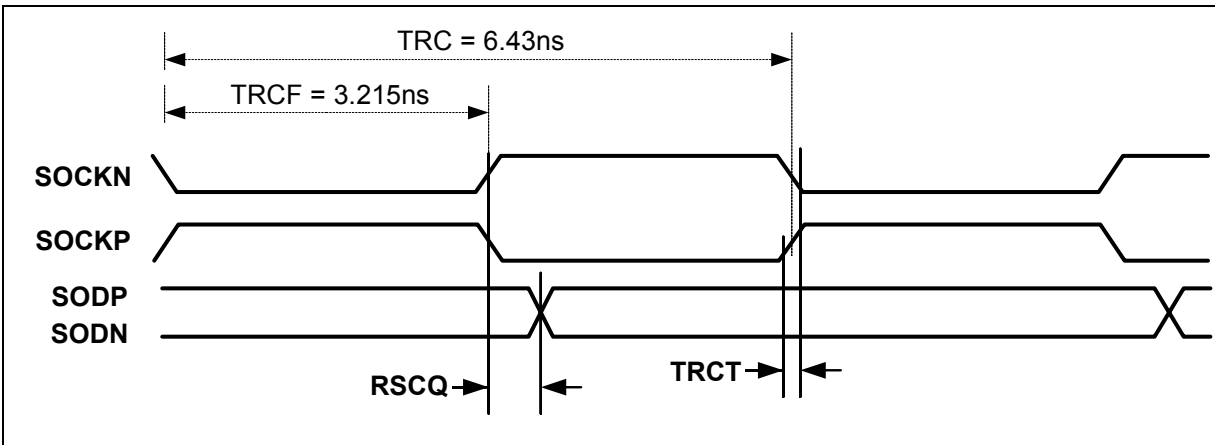

ELECTRICAL SPECIFICATIONS (continued)

TRANSMITTER SPECIFICATIONS FOR CMI INTERFACE

Bit Rate: 139.264 Mbps \pm 15ppm or 155.52 Mbps \pm 20ppm

Code: Coded Mark Inversion (CMI)

Relevant Specifications: ITU-T G.703, Telcordia GR-253, ANSI T1.102

With the coaxial output port driving a 75 Ω load, the output pulses conform to the templates in Figures 12, 13, 14 and 15. These specifications are tested during production test. Consult application note for reference schematic, layout guidelines, and recommended transformers.

| PARAMETER | CONDITION | MIN | NOM | MAX | UNIT |
|---|---|-------|------|------|------|
| Peak-to-peak Output Voltage (Fuse-trimmed to nominal target at final test) | Template, steady state | 0.9 | 1.05 | 1.1 | V |
| Rise/ Fall Time | 10-90% | | | 2 | ns |
| Transition Timing Tolerance | Negative Transitions | -0.1 | | 0.1 | ns |
| | Positive Transitions at Interval Boundaries | -0.5 | | 0.5 | |
| | Positive Transitions at mid-interval | -0.35 | | 0.35 | |
| Transmit clock frequency stability (PICK or SICKP/N) | With respect to CKREF | 0 | | 0 | ppm |

The following specifications are not tested during production test. They are included for information only.

| PARAMETER | CONDITION | MIN | NOM | MAX | UNIT |
|------------------|----------------------|-----|--------|-----|------------------|
| Output Impedance | Driver is open drain | | 1 8 | | M Ω pF |
| Return Loss | 7MHz to 240MHz | 15 | | | dB |

ELECTRICAL SPECIFICATIONS (continued)

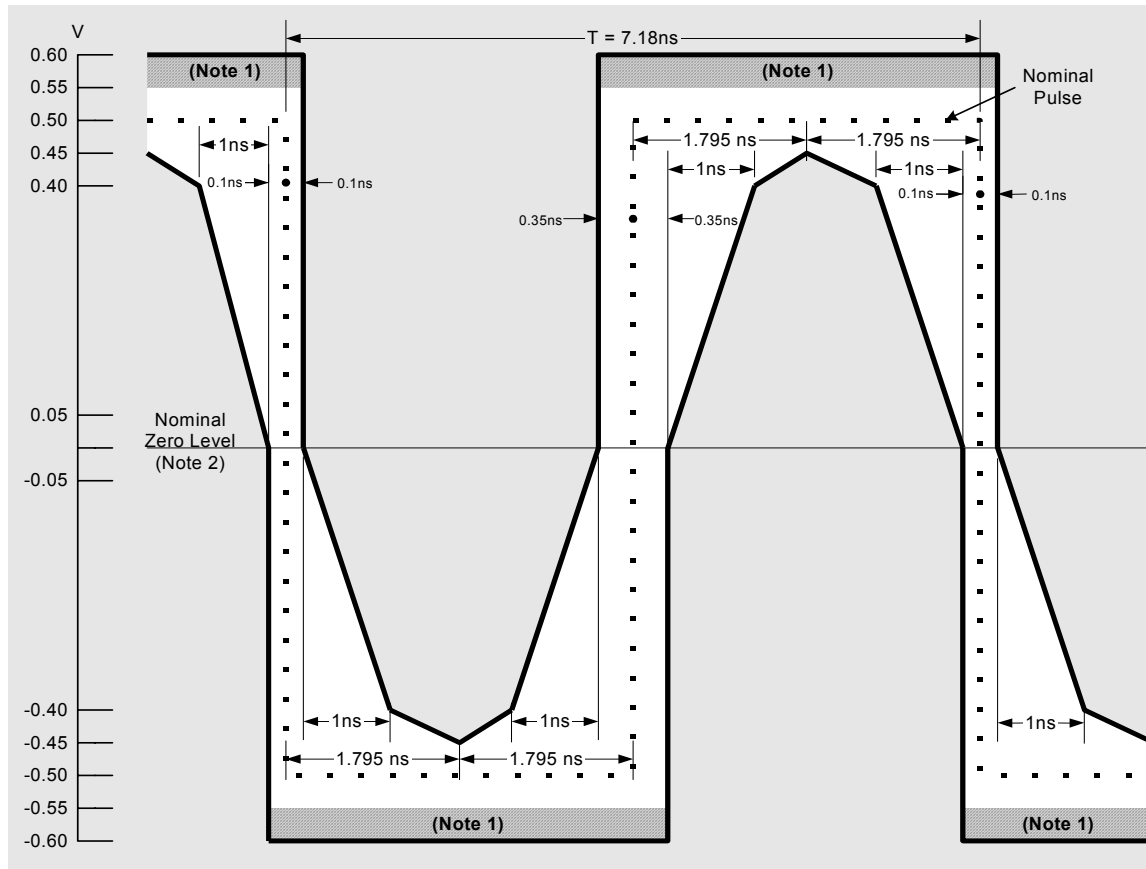

Note 1 – The maximum “steady state” amplitude should not exceed the 0.55V limit. Overshoots and other transients are permitted to fall into the shaded area bounded by the amplitude levels 0.55V and 0.6V, provided that they do not exceed the steady state level by more than 0.05V.

Note 2 – For all measurements using these masks, the signal should be AC coupled, using a capacitor of not less than 0.01 μ F, to the input of the oscilloscope used for measurements. The nominal zero level for both masks should be aligned with the oscilloscope trace with no input signal. With the signal then applied, the vertical position of the trace can be adjusted with the objective of meeting the limits of the masks. Any such adjustment should be the same for both masks and should not exceed ± 0.05 V. This may be checked by removing the input signal again and verifying that the trace lies with ± 0.05 V of the nominal zero level of the masks.

Note 3 – Each pulse in a coded pulse sequence should meet the limits of the relevant mask, irrespective of the state of the preceding or succeeding pulses, with both pulse masks fixed in the same relation to a common timing reference, i.e. with their nominal start and finish edges coincident. The masks allow for HF jitter caused by intersymbol interference in the output stage, but not for jitter present in the timing signal associated with the source of the interface signal. When using an oscilloscope technique to determine pulse compliance with the mask, it is important that successive traces of the pulses overlay in order to suppress the effects of low frequency jitter. This can be accomplished by several techniques [e.g. a) triggering the oscilloscope on the measured waveform or b) providing both the oscilloscope and the pulse output circuits with the same clock signal].

Note 4 – For the purpose of these masks, the rise time and decay time should be measured between -0.4 V and 0.4 V, and should not exceed 2ns.

Figure 12 – Mask of a Pulse corresponding to a binary Zero in E4 mode

ELECTRICAL SPECIFICATIONS (continued)

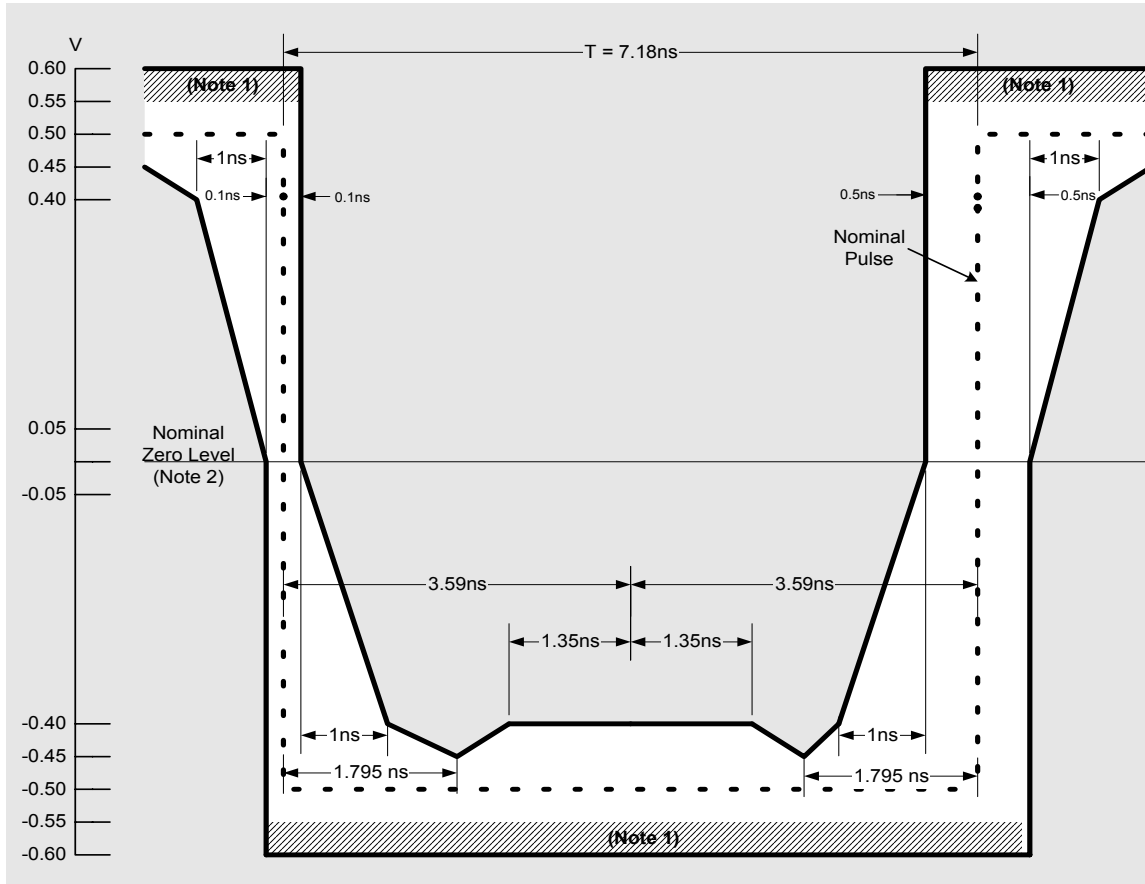

Note 1 – The maximum “steady state” amplitude should not exceed the 0.55V limit. Overshoots and other transients are permitted to fall into the shaded area bounded by the amplitude levels 0.55V and 0.6V, provided that they do not exceed the steady state level by more than 0.05V.

Note 2 – For all measurements using these masks, the signal should be AC coupled, using a capacitor of not less than 0.01 μ F, to the input of the oscilloscope used for measurements. The nominal zero level for both masks should be aligned with the oscilloscope trace with no input signal. With the signal then applied, the vertical position of the trace can be adjusted with the objective of meeting the limits of the masks. Any such adjustment should be the same for both masks and should not exceed ± 0.05 V. This may be checked by removing the input signal again and verifying that the trace lies with ± 0.05 V of the nominal zero level of the masks.

Note 3 – Each pulse in a coded pulse sequence should meet the limits of the relevant mask, irrespective of the state of the preceding or succeeding pulses, with both pulse masks fixed in the same relation to a common timing reference, i.e. with their nominal start and finish edges coincident. The masks allow for HF jitter caused by intersymbol interference in the output stage, but not for jitter present in the timing signal associated with the source of the interface signal. When using an oscilloscope technique to determine pulse compliance with the mask, it is important that successive traces of the pulses overlay in order to suppress the effects of low frequency jitter. This can be accomplished by several techniques [e.g. a) triggering the oscilloscope on the measured waveform or b) providing both the oscilloscope and the pulse output circuits with the same clock signal].

Note 4 – For the purpose of these masks, the rise time and decay time should be measured between -0.4 V and 0.4 V, and should not exceed 2ns.

Note 5 –The inverse pulse will have the same characteristics, noting that the timing tolerance at the level of the negative and positive transitions are ± 0.1 ns and ± 0.5 ns respectively.

Figure 13 – Mask of a Pulse corresponding to a binary One in E4 mode.

ELECTRICAL SPECIFICATIONS (continued)

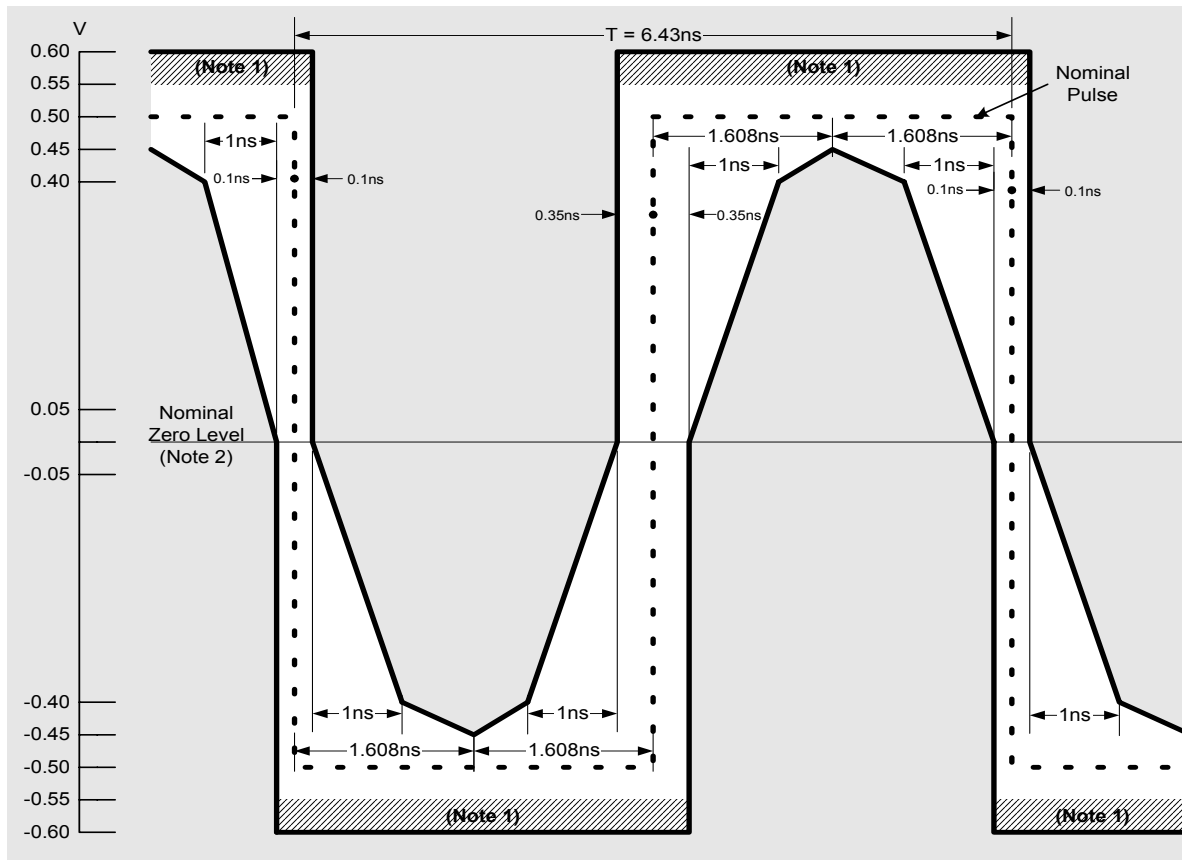

Note 1 – The maximum “steady state” amplitude should not exceed the 0.55V limit. Overshoots and other transients are permitted to fall into the shaded area bounded by the amplitude levels 0.55V and 0.6V, provided that they do not exceed the steady state level by more than 0.05V.

Note 2 – For all measurements using these masks, the signal should be AC coupled, using a capacitor of not less than 0.01 μ F, to the input of the oscilloscope used for measurements. The nominal zero level for both masks should be aligned with the oscilloscope trace with no input signal. With the signal then applied, the vertical position of the trace can be adjusted with the objective of meeting the limits of the masks. Any such adjustment should be the same for both masks and should not exceed ± 0.05 V. This may be checked by removing the input signal again and verifying that the trace lies with ± 0.05 V of the nominal zero level of the masks.

Note 3 – Each pulse in a coded pulse sequence should meet the limits of the relevant mask, irrespective of the state of the preceding or succeeding pulses, with both pulse masks fixed in the same relation to a common timing reference, i.e. with their nominal start and finish edges coincident. The masks allow for HF jitter caused by intersymbol interference in the output stage, but not for jitter present in the timing signal associated with the source of the interface signal. When using an oscilloscope technique to determine pulse compliance with the mask, it is important that successive traces of the pulses overlay in order to suppress the effects of low frequency jitter. This can be accomplished by several techniques [e.g. a) triggering the oscilloscope on the measured waveform or b) providing both the oscilloscope and the pulse output circuits with the same clock signal].

Note 4 – For the purpose of these masks, the rise time and decay time should be measured between -0.4 V and 0.4 V, and should not exceed 2ns.

Figure 14 – Mask of a Pulse corresponding to a binary Zero in STM-1/STS-3 mode.

ELECTRICAL SPECIFICATIONS (continued)

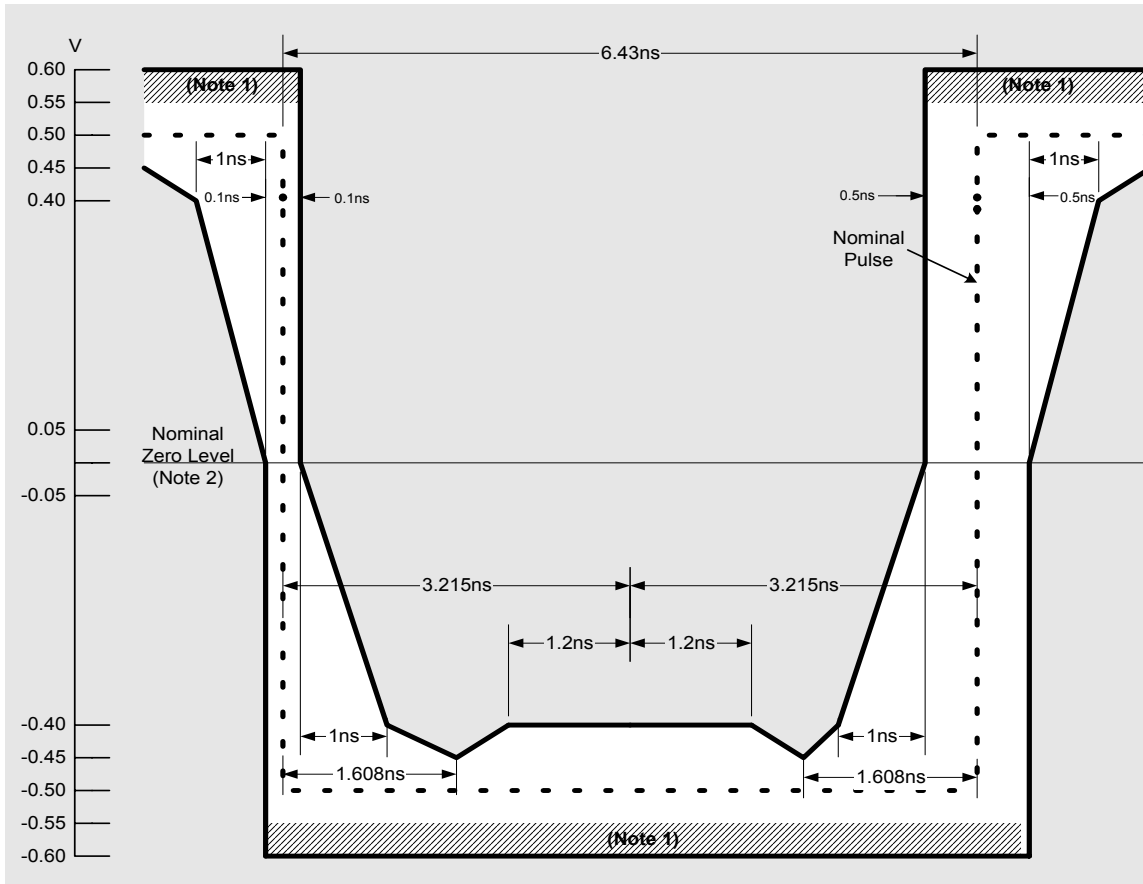

Note 1 – The maximum “steady state” amplitude should not exceed the 0.55V limit. Overshoots and other transients are permitted to fall into the shaded area bounded by the amplitude levels 0.55V and 0.6V, provided that they do not exceed the steady state level by more than 0.05V.

Note 2 – For all measurements using these masks, the signal should be AC coupled, using a capacitor of not less than 0.01 μ F, to the input of the oscilloscope used for measurements. The nominal zero level for both masks should be aligned with the oscilloscope trace with no input signal. With the signal then applied, the vertical position of the trace can be adjusted with the objective of meeting the limits of the masks. Any such adjustment should be the same for both masks and should not exceed ± 0.05 V. This may be checked by removing the input signal again and verifying that the trace lies with ± 0.05 V of the nominal zero level of the masks.

Note 3 – Each pulse in a coded pulse sequence should meet the limits of the relevant mask, irrespective of the state of the preceding or succeeding pulses, with both pulse masks fixed in the same relation to a common timing reference, i.e. with their nominal start and finish edges coincident. The masks allow for HF jitter caused by intersymbol interference in the output stage, but not for jitter present in the timing signal associated with the source of the interface signal. When using an oscilloscope technique to determine pulse compliance with the mask, it is important that successive traces of the pulses overlay in order to suppress the effects of low frequency jitter. This can be accomplished by several techniques [e.g. a) triggering the oscilloscope on the measured waveform or b) providing both the oscilloscope and the pulse output circuits with the same clock signal].

Note 4 – For the purpose of these masks, the rise time and decay time should be measured between -0.4 V and 0.4 V, and should not exceed 2ns.

Note 5 – The inverse pulse will have the same characteristics, noting that the timing tolerance at the level of the negative and positive transitions are ± 0.1 ns and ± 0.5 ns respectively.

Figure 15 – Mask of a Pulse corresponding to a binary One in STM-1/STS-3 mode

ELECTRICAL SPECIFICATIONS (continued)

TRANSMITTER OUTPUT JITTER

The transmit jitter specification ensures compliance with ITU-T G.813, G.823, G.825 and G.958; ANSI T1.102-1993 and T1.105.03-1994; and GR-253-CORE for all supported rates. Transmit output jitter is not tested during production test.

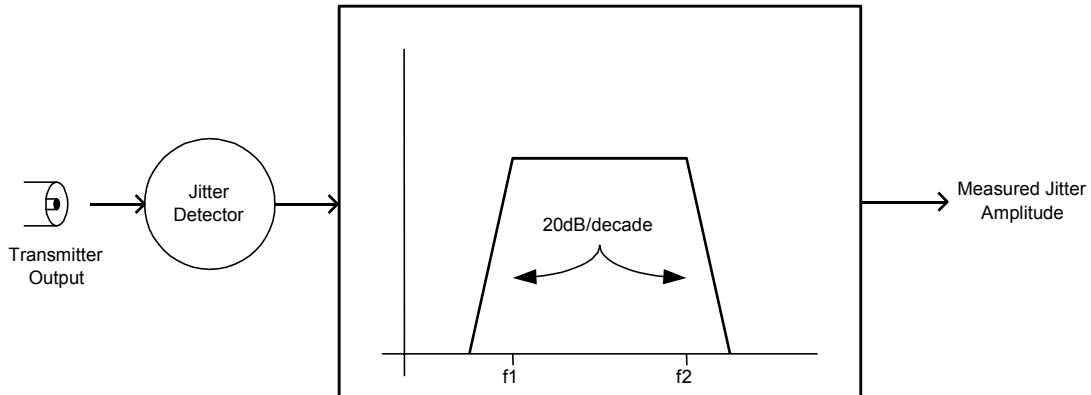

| PARAMETER | CONDITION | MIN | NOM | MAX | UNIT |
|---------------------------|--|-----|-----|-------|-------------------|
| Transmitter Output Jitter | CMI Mode; 200 Hz to 3.5 MHz, measured with respect to CKREF for 60s | | | 0.075 | U _{lpp} |
| | NRZ (optical) Mode; 12 kHz to 1.3 MHz, measured with respect to CKREF | | | 0.01 | U _{lrms} |

ELECTRICAL SPECIFICATIONS (continued)

RECEIVER SPECIFICATIONS FOR CMI INTERFACE (Transformer-coupled)

Consult application note for reference schematic, layout guidelines, and recommended transformers.

| PARAMETER | CONDITION | MIN | TYP | MAX | UNIT |
|--|---|-----|-----|-------------|--------------|
| Peak Differential Input Amplitude, RXP and RXN | CMI mode; MON=0; 12.7dB of cable loss | 70 | | 550 | mVpk |
| Peak Differential Input Amplitude, RXP and RXN | CMI mode; MON=1; 20dB flat loss w/ 6dB of cable loss | 25 | | 80 | mVpk |
| Flat-loss Tolerance | CMI mode; MON=0; All valid cable lengths. | -2 | | 6 | dB |
| Receive Clock Jitter | STM-1 mode; CMI mode; 12.7 dB cable loss a) Normal receive mode b) Remote loopback mode | | | 0.1 0.07 | UIpp UIpp |
| Latency | | | 5 | 10 | UI |
| PLL Lock Time | | | 1 | 10 | μs |
| Return Loss | 7MHz to 240MHz | 15 | | | dB |

The input signal is assumed compliant with ITU-T G.703 and can be attenuated by the dispersive loss of a cable. The minimum cable loss is 0dB and the maximum is -12.7dB at 78MHz.

The “Worst Case” line corresponds to the ITU-T G.703 recommendation. The “Typical” line corresponds to a typical installation referred to in ANSI T1.102-1993. The receiver is tested using the cable model. It is a lumped element approximation of the “Worst Case” line.

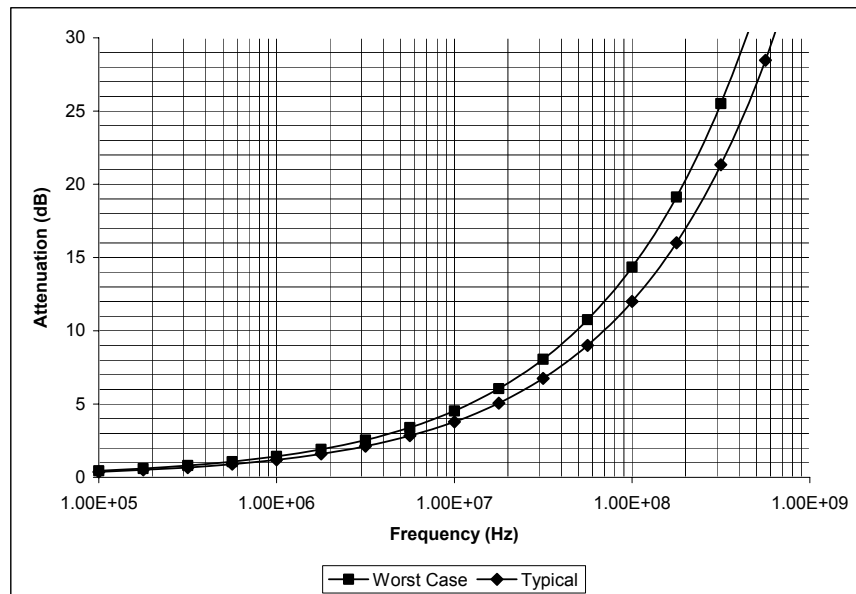

Figure 16: Typical and worst-case Cable attenuation

ELECTRICAL SPECIFICATIONS (continued)

RECEIVER JITTER TOLERANCE

The 78P2351 exceeds all relevant jitter tolerance specifications shown in Figures 17, 18. STS-3/OC-3 jitter tolerance specifications are in ANSI T1.105.03-1994 and Telcordia GR-253-CORE. STM-1 (optical) jitter tolerance specifications are in ITU-T G.813, G.825, and G.958. STM-1e (electrical) jitter tolerance specifications are in ITU-T G.825. E4 specifications are found in ITU-T G.823. Receive jitter tolerance is not tested during production test.

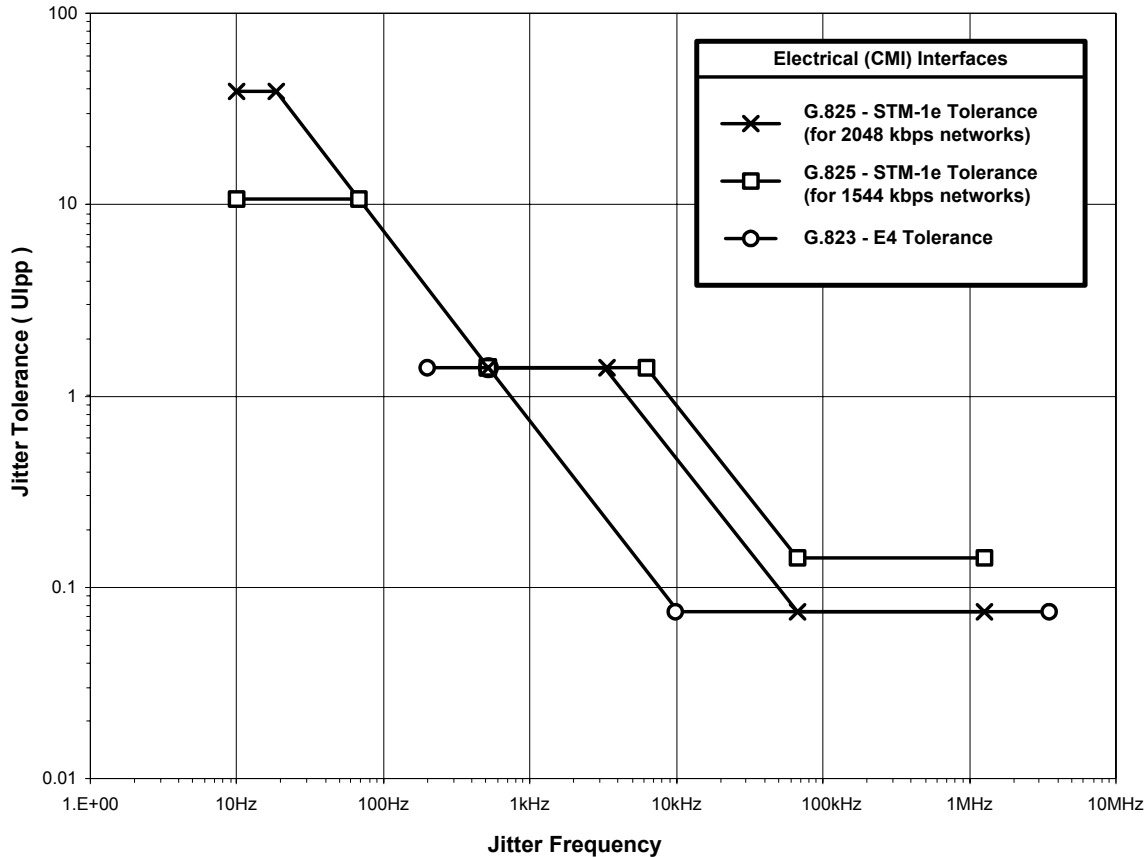
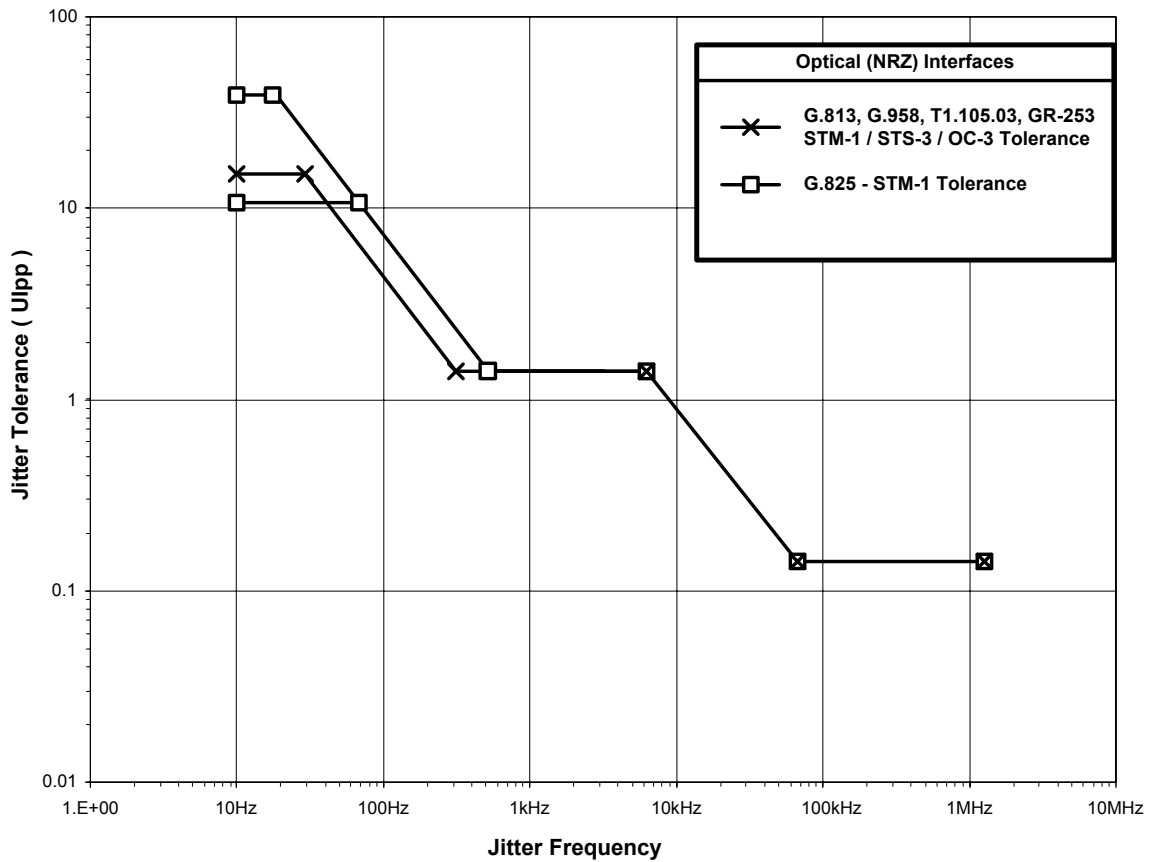

Figure 17: Jitter Tolerance - electrical (CMI) interfaces

| PARAMETER | CONDITION | MIN | NOM | MAX | UNIT |
|-------------------------|-----------------|-------|----------|-----|------|
| E4 Jitter Tolerance | 200Hz to 500Hz | 1.5 | | | UIpp |
| | 500Hz to 10kHz | | 750 f-1 | | μs |
| | 10kHz to 3.5MHz | 0.075 | | | UIpp |
| STM-1e Jitter Tolerance | 10Hz to 19.3Hz | 38.9 | | | UIpp |
| | 19.3Hz to 500Hz | | 750 f-1 | | μs |
| | 500Hz to 6.5kHz | 1.5 | | | UIpp |
| | 6.5kHz to 65kHz | | 9800 f-1 | | μs |
| | 65kHz to 1.3MHz | 0.15 | | | UIpp |

ELECTRICAL SPECIFICATIONS (continued)

Figure 18: Jitter Tolerance - optical (NRZ) interfaces

| PARAMETER | CONDITION | MIN | NOM | MAX | UNIT |
|--|------------------|------|----------|-----|------|
| OC-3/STS-3/STM-1 (optical) Jitter Tolerance | 10Hz to 19.3Hz | 38.9 | | | Ujpp |
| | 19.3Hz to 68.7Hz | | 750 f-1 | | μs |
| | 68.7Hz to 6.5kHz | 1.5 | | | Ujpp |
| | 6.5kHz to 65kHz | | 9800 f-1 | | μs |
| | 65kHz to 1.3MHz | 0.15 | | | Ujpp |

ELECTRICAL SPECIFICATIONS (continued)

RECEIVER JITTER TRANSFER FUNCTION

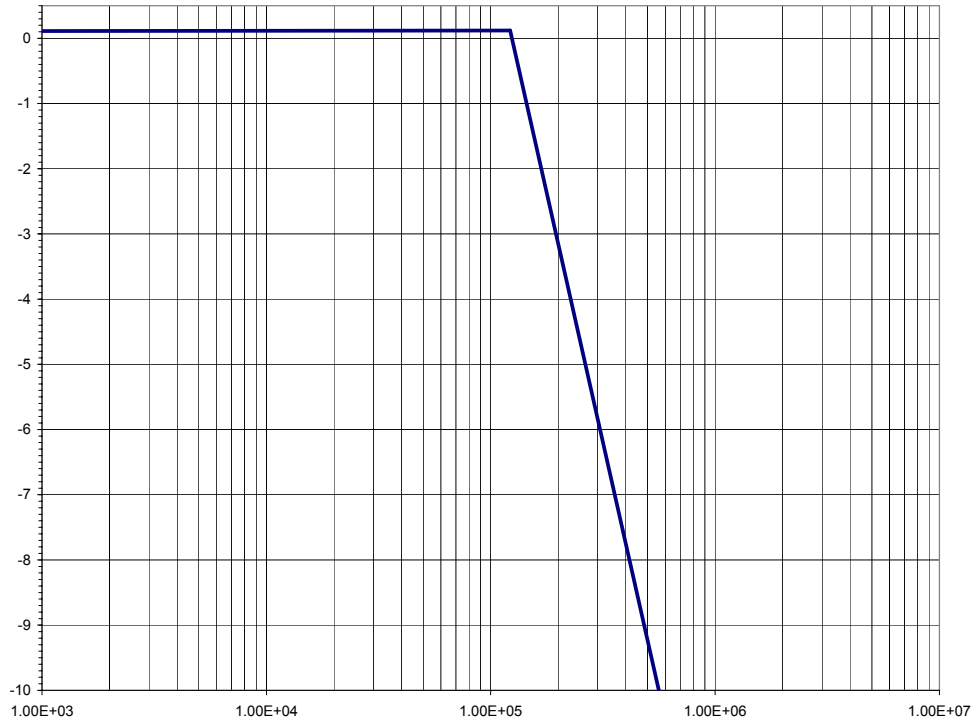
The receiver clock recovery loop filter characteristics such that the receiver has the following transfer function. The corner frequency of the Rx DLL is approximately 120 kHz. Receiver jitter transfer function is not tested during production test.

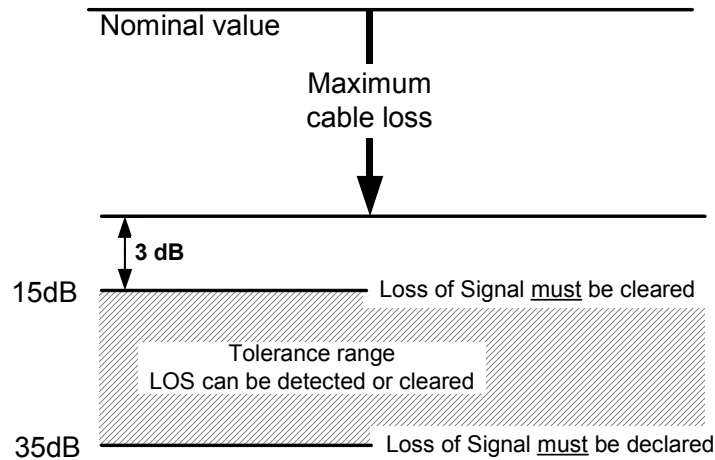

Figure 19: Jitter Transfer

| PARAMETER | CONDITION | MIN | NOM | MAX | UNIT |
|-----------------------------------|---------------|-----|-----|-----|---------------|
| Receiver Jitter transfer function | below 120 kHz | | | 0.1 | dB |
| Jitter transfer function roll-off | | | 20 | | dB per decade |

ELECTRICAL SPECIFICATIONS (continued)

CMI MODE LOSS OF SIGNAL CONDITION

| PARAMETER | CONDITION | MIN | TYP | MAX | UNIT |
|---------------|-----------|-----|-----|-----|------|
| LOS threshold | | -35 | -19 | -15 | dB |
| LOS timing | | 10 | 110 | 255 | UI |



APPLICATION INFORMATION

EXTERNAL COMPONENTS:

| COMPONENT | PIN(S) | VALUE | UNITS | TOLERANCE |
|--|--------------|-------|----------|-----------|
| Receiver Termination Resistor, CMI Mode | RXP RXN | 75 | Ω | 1% |
| Transmitter Termination Resistor, CMI Mode | CMIP CMIN | 75 | Ω | 1% |

(CMI) TRANSFORMER SPECIFICATIONS:

| COMPONENT | VALUE | UNITS | TOLERANCE |
|---|-------|-------|-----------|
| Turns Ratio for the Receiver | | 1:1 | |
| Turns Ratio for the Transmitter (center-tapped) | | 1:1CT | |

Suggested Manufacturers: Halo, Tamura, MiniCircuits, Belfuse

THERMAL INFORMATION:

| PACKAGE | CONDITIONS | Θ_{JA} (°C/W) |
|-----------------------------|--|-----------------------|
| Standard 100-pin JEDEC LQFP | No forced air; 4-layer JEDEC test board | 46 |

SCHEMATICS

For reference schematics, layout guidelines, recommended transformer part numbers, etc. please check Teridian Semiconductor's website or contact your local sales representative for the latest application note(s) and/or demo board manuals.

MECHANICAL SPECIFICATIONS

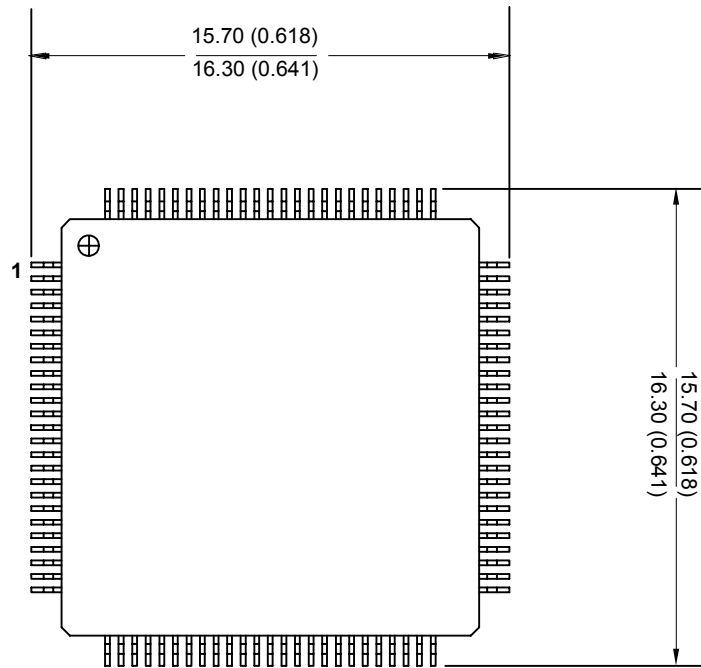

Top View

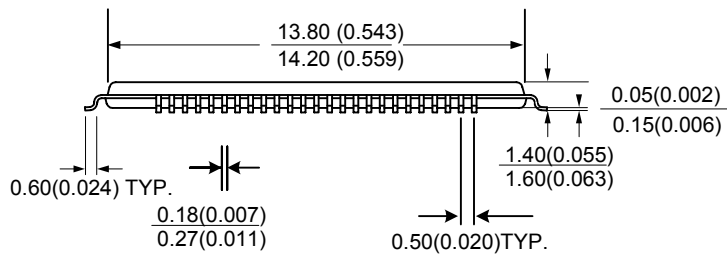

Side View

100-pin JEDEC LQFP
(Top View)

PACKAGE INFORMATION
 (Top View)

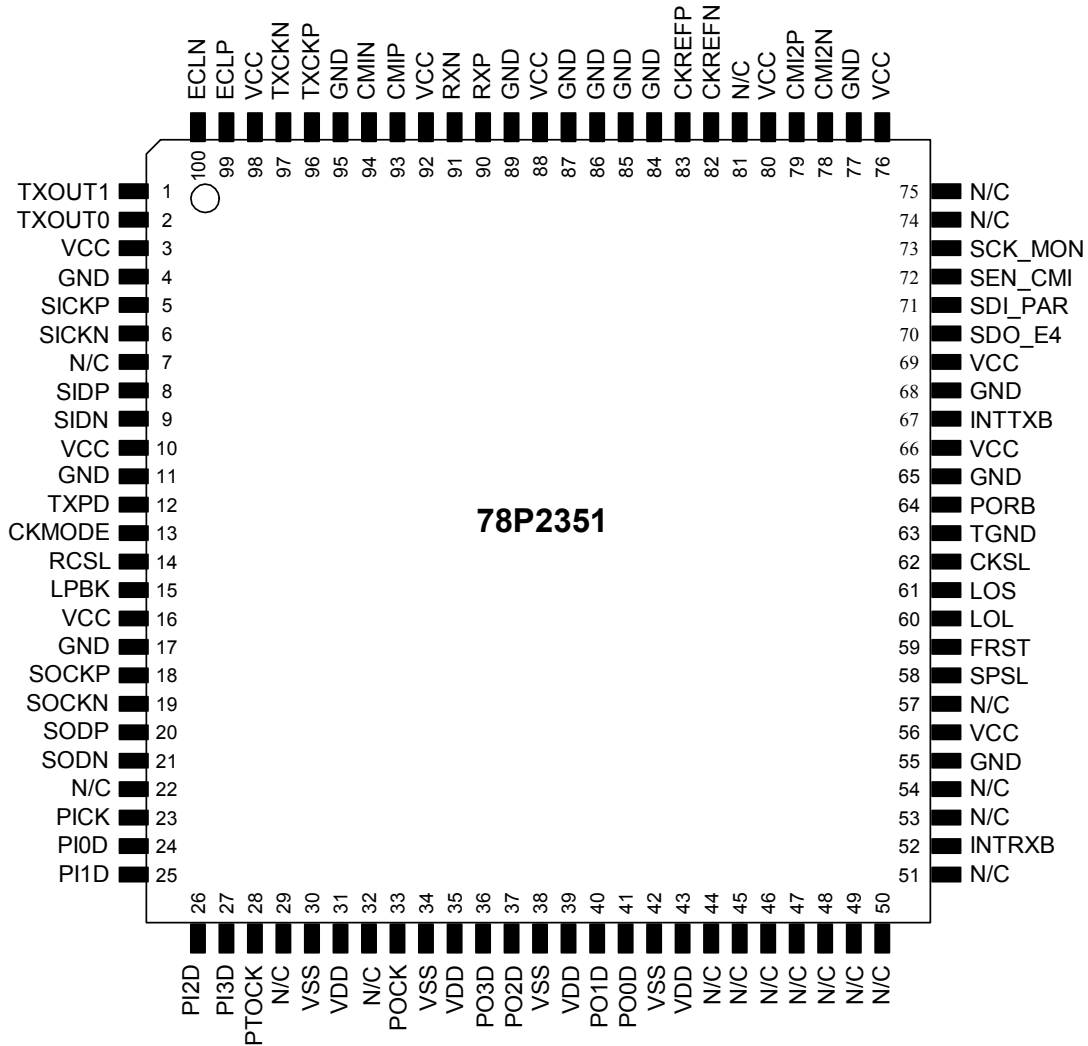

ORDERING INFORMATION

| PART DESCRIPTION | ORDER NUMBER | PACKAGE MARK |
|----------------------------|-------------------|------------------------------|
| 100-pin LQFP; Revision A06 | 78P2351-IGT | 78P2351-IGT xxxxxxxxxxP6 |
| Tape & Reel option | <i>append 'R'</i> | n/a |
| Lead-free option | <i>append 'F'</i> | xxxxxxx-xxx xxxxxxxxxxP6F |

| Revision History | |
|-------------------------|--|
| -- | Contact Teridian for revision history of earlier releases |
| v2-0 | March 14, 2005: Final Datasheet Release <ul style="list-style-type: none"> ▪ Updated Ordering Numbers to reflect production silicon revision A06 <ul style="list-style-type: none"> ○ Obsoleted 70Pxxxx option (CMOS Output type status & interrupt pins) ▪ Improved/modified Functional Descriptions for: <ul style="list-style-type: none"> ○ Reference Clock, Rx LOS & LOL detectors, Synchronous (Re-Timing) Transmit Modes, Tx FIFO, Tx Driver, Tx LOL detector, and Power-on Reset description ▪ Improved/modified Register Descriptions for: <ul style="list-style-type: none"> ○ xCMIINV invert bits, FRST, RxLOL, and TxLOL ▪ Improved/modified Pin Descriptions for: <ul style="list-style-type: none"> ○ PTOCK, FRST, SEN_CMI, GND pin 63 ▪ Updated Electrical Specification min/max limits for: <ul style="list-style-type: none"> ○ DC Characteristics, ○ CID, CIU, CIT, and PO pin types ○ CMI Loss of Signal Conditions |
| v2-2 | August 12, 2005: <ul style="list-style-type: none"> ▪ Changed name and logo from TDK to Teridian ▪ Updated Rx and Tx Loss of Lock descriptions ▪ Added Full Remote (digital) Loopback and update Remote (analog) Loopback descriptions |
| v2-3 | August 15, 2006 <ul style="list-style-type: none"> ▪ Updated Ordering Numbers to remove silicon revision A06 ▪ Updated Package Mark from C6 to P6 |
| v2-4 | September 20, 2006 <ul style="list-style-type: none"> ▪ Corrected several typos in the mechanical drawing |

If and when manufactured and sold, this product is sold subject to the terms and conditions of sale supplied at the time of order acknowledgment, including those pertaining to warranty, patent infringement and limitation of liability. Teridian Semiconductor Corporation (TSC) reserves the right to make changes in specifications at any time without notice. Accordingly, the reader is cautioned to verify that a data sheet is current before placing orders. TSC assumes no liability for applications assistance.

Teridian Semiconductor Corp., 6440 Oak Canyon, Irvine, CA 92618
 TEL (714) 508-8800, FAX (714) 508-8877, <http://www.teridiansemiconductor.com>