



# OPA4243



For most current data sheet and other product information, visit [www.burr-brown.com](http://www.burr-brown.com)

## Quad OPERATIONAL AMPLIFIER *MicroPOWER, Single-Supply*

### FEATURES

- MICRO-SIZE, TSSOP PACKAGE
- SINGLE-SUPPLY OPERATION
- WIDE SUPPLY RANGE: 2.2V to 36V
- LOW QUIESCENT CURRENT: 45 $\mu$ A/chan
- WIDE BANDWIDTH: 430kHz
- WIDE INPUT/OUTPUT SWING

### APPLICATIONS

- LCD DISPLAY DRIVERS
- BATTERY POWERED SYSTEMS
- PORTABLE EQUIPMENT
- PCMCIA CARDS
- BATTERY PACKS AND POWER SUPPLIES
- CONSUMER PRODUCTS

### DESCRIPTION

The OPA4243 is a four-channel op amp specifically designed for high density, space-limited applications, such as LCD bias drivers, PCMCIA cards, battery-packs and portable instruments. In addition to small size, this part features wide output swing, very low quiescent current, and low bias current. Other features include unity gain stability and the best speed power ratio available. Power supplies in the range of 2.2V to 36V ( $\pm 1.1V$  to  $\pm 18V$ ) can be used.

Each channel uses completely independent circuitry for lowest crosstalk and freedom from interaction, even when overloaded. In addition, the amplifier is free from output inversion when the inputs are driven to the rail. The OPA4243EA is supplied in the miniature TSSOP-14 surface mount package. Specifications apply from  $-40^{\circ}C$  to  $+85^{\circ}C$ . However, as the extensive typical performance curves indicate, the OPA4243 can be used over the full  $-55^{\circ}C$  to  $+125^{\circ}C$  range. A SPICE macromodel is available for design analysis.

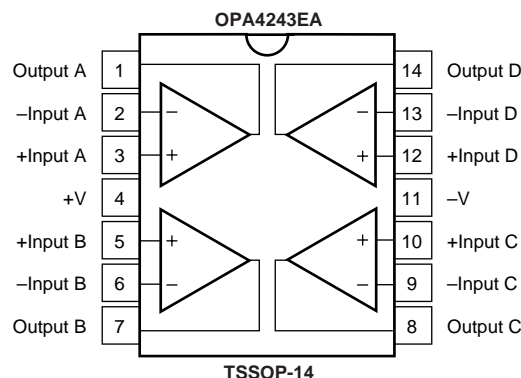

International Airport Industrial Park • Mailing Address: PO Box 11400, Tucson, AZ 85734 • Street Address: 6730 S. Tucson Blvd., Tucson, AZ 85706 • Tel: (520) 746-1111  
Twx: 910-952-1111 • Internet: <http://www.burr-brown.com/> • Cable: BBRCORP • Telex: 066-6491 • FAX: (520) 889-1510 • Immediate Product Info: (800) 548-6132

# SPECIFICATIONS: $V_S = +2.6V$ to $+36V$

**Boldface** limits apply over the specified temperature range,  $T_A = -40^\circ\text{C}$  to  $+85^\circ\text{C}$

At  $T_A = +25^\circ\text{C}$ ,  $R_L = 20\text{k}\Omega$  connected to ground, unless otherwise noted.

PARAMETER	CONDITIONS	OPA4243EA			UNITS	
		MIN	TYP <sup>(1)</sup>	MAX		
<b>OFFSET VOLTAGE</b>						
Input Offset Voltage <b>Over Temperature</b>	$V_{OS}$ $V_S = \pm 7.5V, V_{CM} = 0$		$\pm 2$	$\pm 5$	mV	
vs Temperature	$dV_{OS}/dT$ $T_A = -40^\circ\text{C}$ to $+85^\circ\text{C}$		$\pm 2.5$	$\pm 6$	mV	
vs Power Supply	PSRR $V_S = +2.6V$ to $+36V$		2.5	100	$\mu\text{V}/^\circ\text{C}$	
<b>Over Temperature</b>	$V_S = +2.6V$ to $+36V$			<b>100</b>	$\mu\text{V}/V$	
Channel Separation			140		dB	
<b>INPUT BIAS CURRENT</b>						
Input Bias Current	$I_R$ $V_{CM} = V_S/2$		-10	-25	nA	
Input Offset Current	$I_{OS}$ $V_{CM} = V_S/2$		$\pm 1$	$\pm 10$	nA	
<b>NOISE</b>						
Input Noise Voltage, $f = 0.1$ to $10\text{Hz}$	$e_n$		0.4		$\mu\text{Vp-p}$	
Input Noise Voltage Density, $f = 1\text{kHz}$	$i_n$		22		$\text{nV}/\sqrt{\text{Hz}}$	
Current Noise Density, $f = 1\text{kHz}$			40		$\text{fA}/\sqrt{\text{Hz}}$	
<b>INPUT VOLTAGE RANGE</b>						
Common-Mode Voltage Range	$V_{CM}$	0		$(V+) - 0.9$	V	
Common-Mode Rejection	CMRR	82	104		dB	
<b>Over Temperature</b>	$V_S = \pm 18V, V_{CM} = -18V$ to $+17.1V$ $V_S = \pm 18V, V_{CM} = -18V$ to $+17.1V$	<b>82</b>			dB	
<b>INPUT IMPEDANCE</b>						
Differential			$10^6 \parallel 2$		$\Omega \parallel \text{pF}$	
Common-Mode			$10^9 \parallel 2$		$\Omega \parallel \text{pF}$	
<b>OPEN-LOOP GAIN</b>						
Open-Loop Voltage Gain	$A_{OL}$ $V_O = 0.5V$ to $(V+) - 0.9$	86	104		dB	
<b>Over Temperature</b>	$V_O = 0.5V$ to $(V+) - 0.9$	<b>86</b>			dB	
<b>FREQUENCY RESPONSE</b>						
Gain-Bandwidth Product	GBW		430		kHz	
Slew Rate	SR		$-0.1, \pm 0.16$		$\text{V}/\mu\text{s}$	
Setting Time, 0.01%			150		$\mu\text{s}$	
Overload Recovery Time	$V_{IN} \cdot \text{Gain} = V_S$		8		$\mu\text{s}$	
<b>OUTPUT</b>						
Voltage Output, Positive	$V_O$	$A_{OL} \geq 80\text{dB}, R_L = 20\text{k}\Omega$ to $V_S/2$	$(V+) - 0.9$	$(V+) - 0.75$	V	
<b>Over Temperature</b>	$A_{OL} \geq 80\text{dB}, R_L = 20\text{k}\Omega$ to $V_S/2$	<b><math>(V+) - 0.9</math></b>		$(V+) - 0.75$	V	
Voltage Output, Negative	$V_O$	$A_{OL} \geq 80\text{dB}, R_L = 20\text{k}\Omega$ to $V_S/2$	0.5	0.2	V	
<b>Over Temperature</b>	$A_{OL} \geq 80\text{dB}, R_L = 20\text{k}\Omega$ to $V_S/2$	<b>0.5</b>		<b>0.2</b>	V	
Voltage Output, Positive	$V_O$	$A_{OL} \geq 80\text{dB}, R_L = 20\text{k}\Omega$ to Ground		$(V+) - 0.75$	V	
<b>Over Temperature</b>	$A_{OL} \geq 80\text{dB}, R_L = 20\text{k}\Omega$ to Ground			$(V+) - 0.75$	V	
Voltage Output, Negative	$V_O$	$A_{OL} \geq 80\text{dB}, R_L = 20\text{k}\Omega$ to Ground		0.1	V	
<b>Over Temperature</b>	$A_{OL} \geq 80\text{dB}, R_L = 20\text{k}\Omega$ to Ground			0.1	V	
Short-Circuit Current	$I_{SC}$	$A_{OL} \geq 80\text{dB}, R_L = 20\text{k}\Omega$ to Ground		-25, +12	mA	
Capacitive Load Drive	$C_{LOAD}$		See Typical Curve			
<b>POWER SUPPLY</b>						
Specified Voltage Range	$V_S$	<b>Over Temperature</b>	<b>+2.6</b>		<b>+36</b>	V
Minimum Operating Voltage	$V_S$			+2.2		V
Quiescent Current	$I_O$	$I_O = 0$		45		$\mu\text{A}$
<b>Over Temperature</b>	$I_O = 0$				<b>70</b>	$\mu\text{A}$
<b>TEMPERATURE RANGE</b>						
Specified Range			-40		85	$^\circ\text{C}$
Operating Range			-55		125	$^\circ\text{C}$
Storage Range			-65		150	$^\circ\text{C}$
Thermal Resistance	$\theta_{JA}$					
TSSOP-14 Surface Mount				100		$^\circ\text{C}/\text{W}$

NOTE: (1)  $V_S = +15V$ .

## ABSOLUTE MAXIMUM RATINGS<sup>(1)</sup>

Supply Voltage, V+ to V- .....	36V
Input Voltage Range <sup>(2)</sup> .....	(V-) - 0.3V to (V+) + 0.3V
Input Current <sup>(2)</sup> .....	10mA
Output Short-Circuit <sup>(3)</sup> .....	Continuous
Operating Temperature .....	-55°C to +125°C
Storage Temperature .....	-65°C to +150°C
Junction Temperature .....	150°C
Lead Temperature (soldering, 10s) .....	300°C
ESD Capability .....	2000V

NOTES: (1) Stresses above these ratings may cause permanent damage. Exposure to absolute maximum conditions for extended periods may degrade device reliability. (2) Inputs are diode-clamped to the supply rails and should be current-limited to 10mA or less if input voltages can exceed rails by more than 0.3V. (3) Short-circuit to ground, one amplifier per package.



## ELECTROSTATIC DISCHARGE SENSITIVITY

This integrated circuit can be damaged by ESD. Burr-Brown recommends that all integrated circuits be handled with appropriate precautions. Failure to observe proper handling and installation procedures can cause damage.

ESD damage can range from subtle performance degradation to complete device failure. Precision integrated circuits may be more susceptible to damage because very small parametric changes could cause the device not to meet its published specifications.

## PACKAGE/ORDERING INFORMATION

PRODUCT	PACKAGE	PACKAGE DRAWING NUMBER	SPECIFIED TEMPERATURE RANGE	PACKAGE MARKING	ORDERING NUMBER <sup>(1)</sup>	TRANSPORT MEDIA
OPA4243EA "	TSSOP-14 "	357 "	-40°C to +85°C "	OPA4243EA "	OPA4243EA/250 OPA4243EA/2K5	Tape and Reel Tape and Reel

NOTE: (1) Models with a slash (/) are available only in Tape and Reel in the quantities indicated (e.g., /2K5 indicates 2500 devices per reel). Ordering 2500 pieces of "OPA4243EA" will get a single 2500-piece Tape and Reel.

# TYPICAL PERFORMANCE CURVES

At  $T_A = +25^\circ\text{C}$ ,  $R_L = 20\text{k}\Omega$  connected to ground, unless otherwise noted.

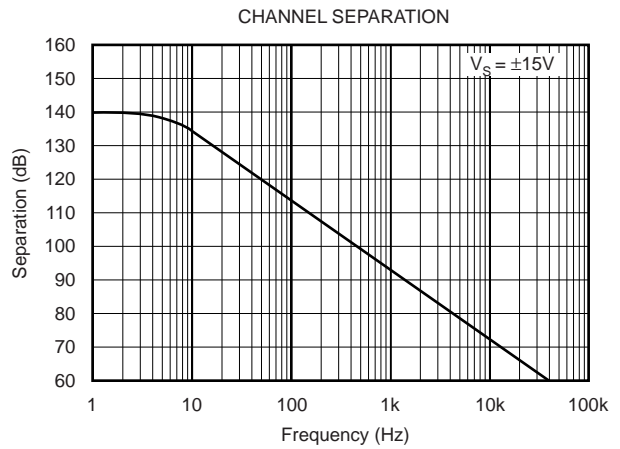
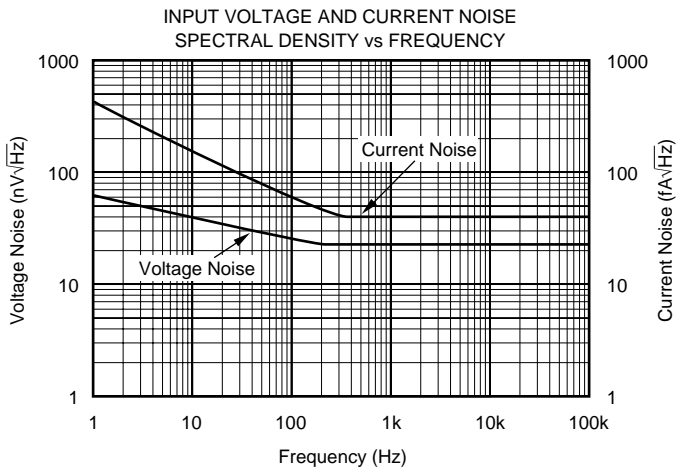
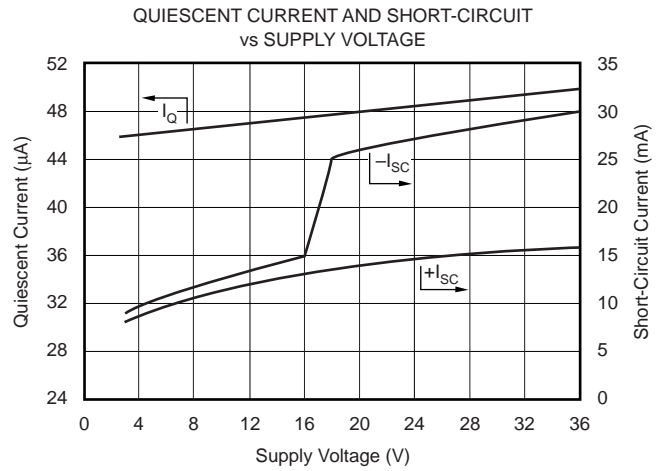
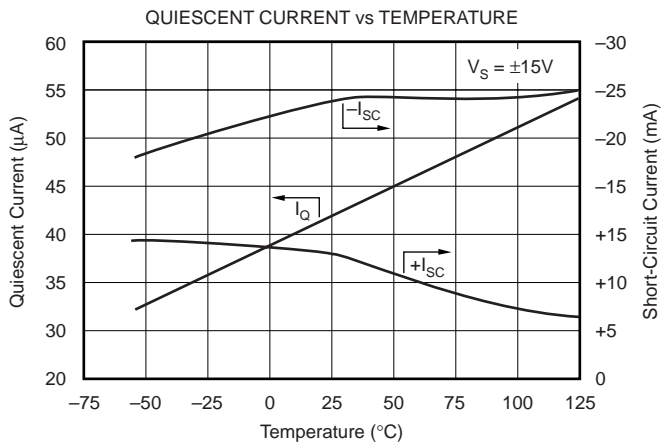
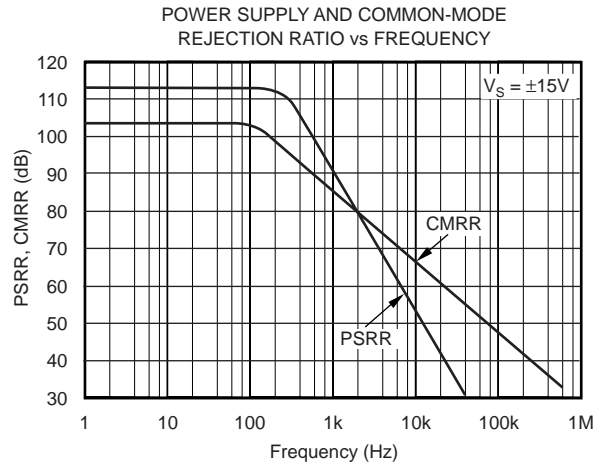
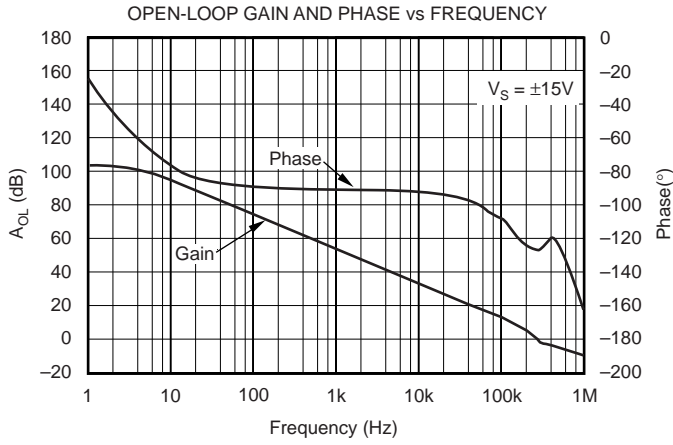

# TYPICAL PERFORMANCE CURVES (Cont.)

At  $T_A = +25^\circ\text{C}$ ,  $R_L = 20\text{k}\Omega$  connected to ground, unless otherwise noted.

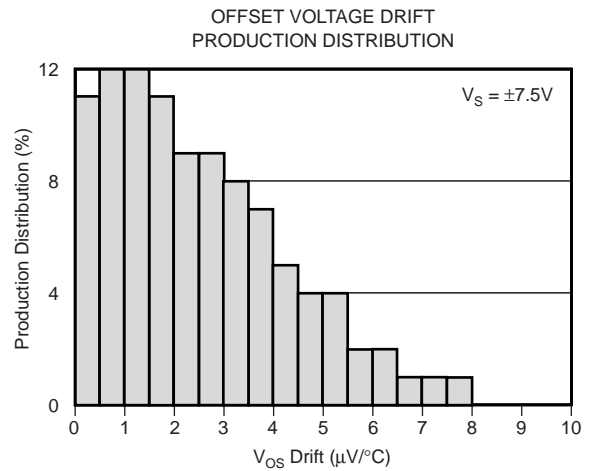
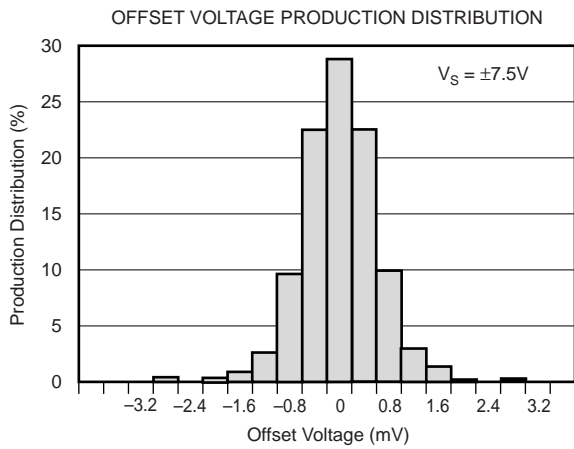
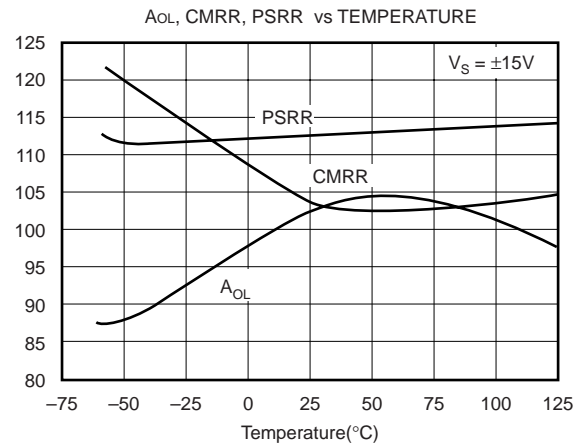
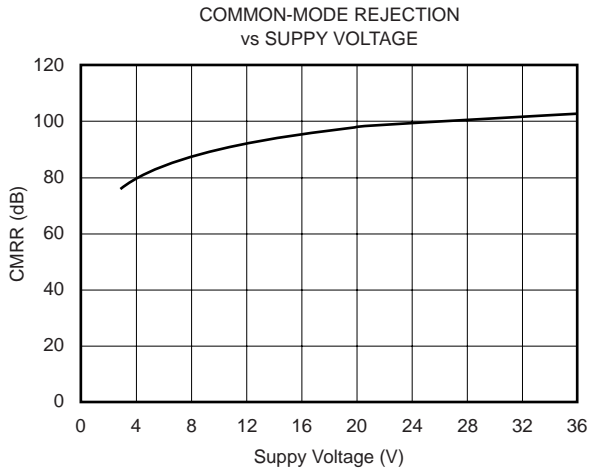
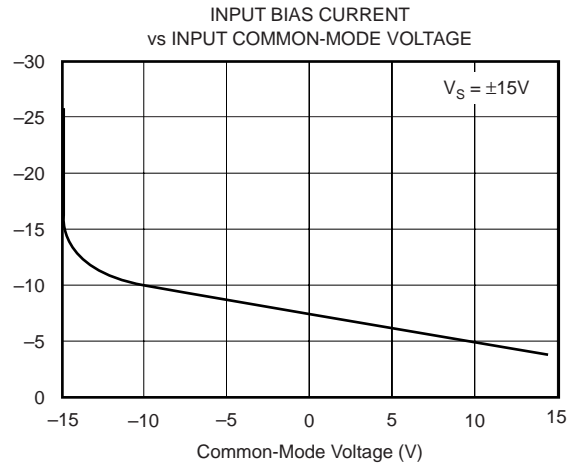
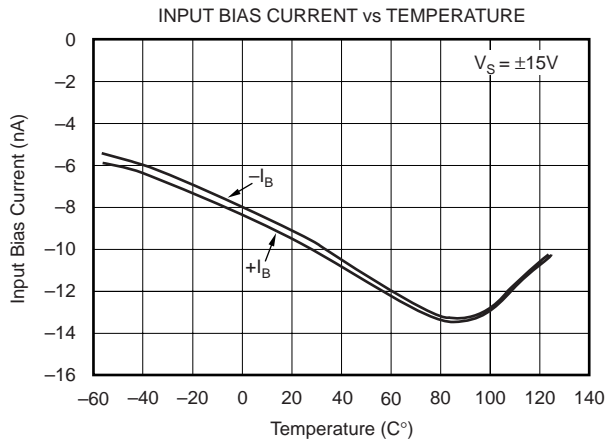

# TYPICAL PERFORMANCE CURVES (Cont.)

At  $T_A = +25^\circ\text{C}$ ,  $R_L = 20\text{k}\Omega$  connected to ground, unless otherwise noted.

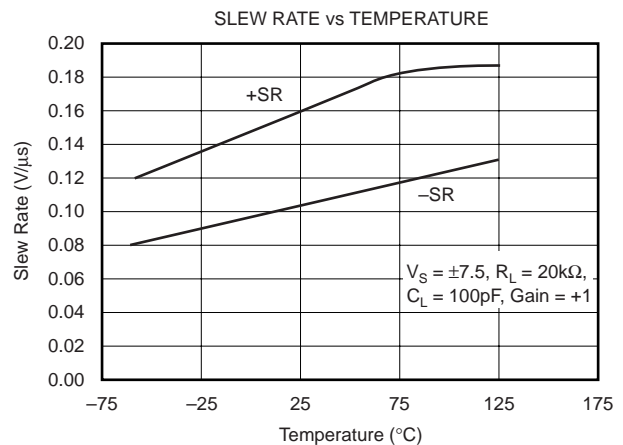
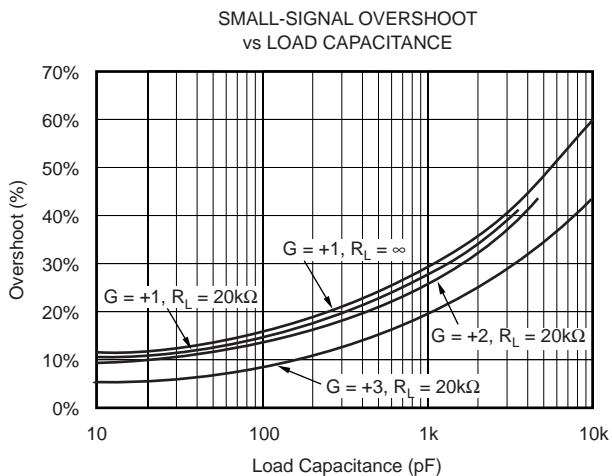
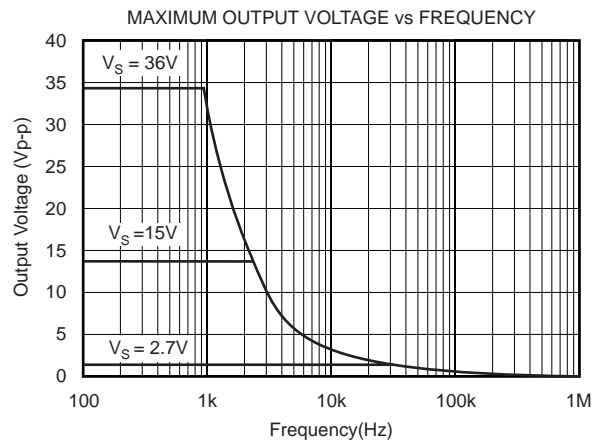
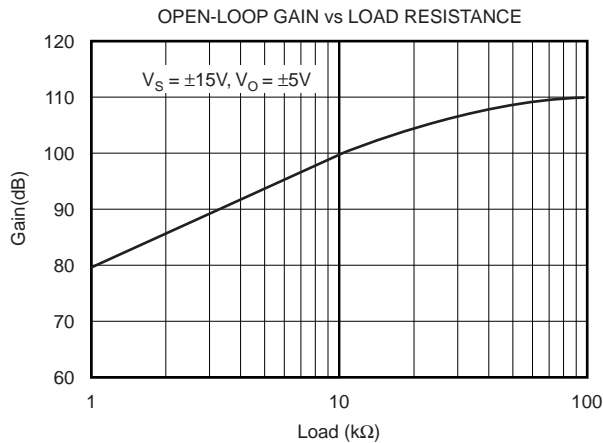
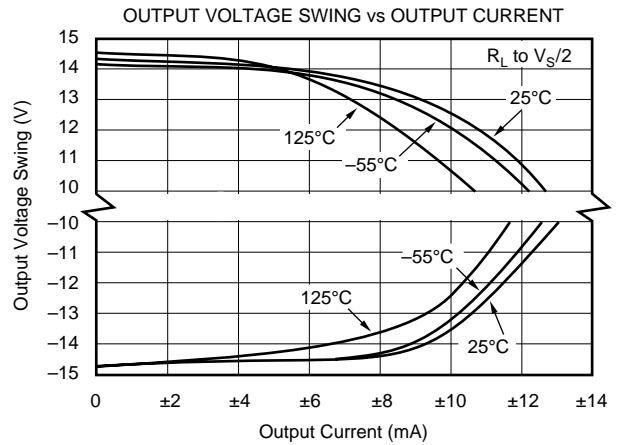
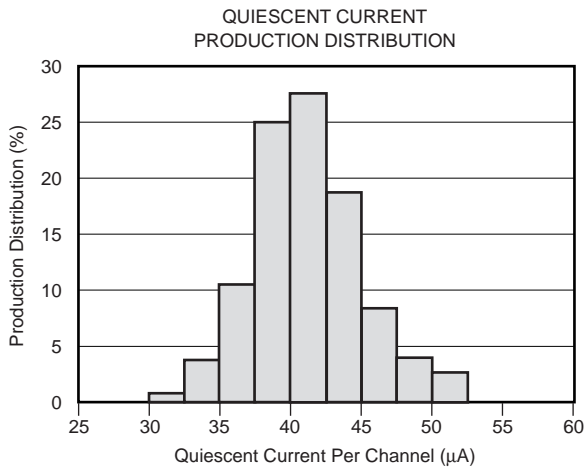

## TYPICAL PERFORMANCE CURVES (Cont.)

At  $T_A = +25^\circ\text{C}$ ,  $R_L = 20\text{k}\Omega$  connected to ground, unless otherwise noted.

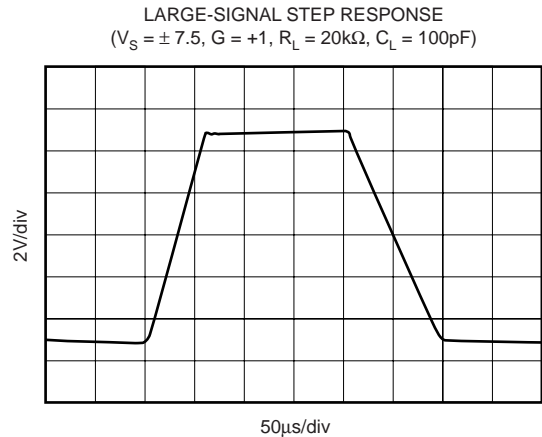
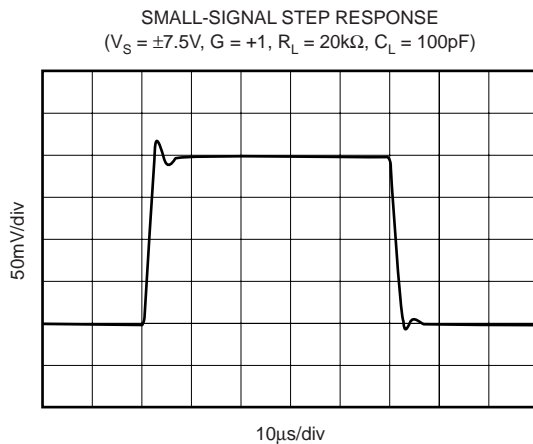

## APPLICATION INFORMATION

The OPA4243 is unity-gain stable and suitable for a wide range of general-purpose applications. The power supply pins should be bypassed with  $0.01\mu\text{F}$  ceramic capacitors.

### OPERATING VOLTAGE

The OPA4243 can operate from single supply (2.2V to 36V) or dual supplies ( $\pm 1.1\text{V}$  to  $\pm 18\text{V}$ ) with excellent performance. Unlike most op amps which are specified at only one supply voltage, the OPA4243 is specified for real world applications; a single set of specifications applies throughout the 2.6V to 36V supply range. This allows the designer to have the same assured performance at any supply voltage within this range.

In addition, many key parameters are guaranteed over the specified temperature range,  $-40^\circ\text{C}$  to  $+85^\circ\text{C}$ . Most behaviors remain unchanged throughout the full operating voltage range. Parameters, which vary significantly with operating voltage or temperature, are shown in the typical performance curves.

### PRINTED CIRCUIT BOARD LAYOUT

See Burr-Brown Application Note AB-132 for specific PC board layout recommendations.

### INPUT PROTECTION

Rail-to-rail input signals will not cause damage or invert the output of the OPA4243. To protect against ESD and excessive input voltage (beyond the supply rails) the OPA4243 includes diodes from the input terminals to the power supply rails. Normally, these diodes are reversed biased and have negligible effect on circuit operation. However, if the input voltage is allowed to exceed the supply voltages by enough to forward bias these diodes (generally, 0.3V to 0.6V) excessive input current could flow. If this condition could occur (for example, if an input signal is applied when the op amp supply voltage is zero), care should be taken to limit the input current to less than 10mA to avoid damage. An input signal beyond the supplies, with power applied, can cause an unexpected output inversion.

**PACKAGING INFORMATION**

Orderable Device	Status <sup>(1)</sup>	Package Type	Package Drawing	Pins	Package Qty	Eco Plan <sup>(2)</sup>	Lead/Ball Finish	MSL Peak Temp <sup>(3)</sup>
OPA4243EA/250	ACTIVE	TSSOP	PW	14	250	Green (RoHS & no Sb/Br)	CU NIPDAU	Level-3-260C-168 HR
OPA4243EA/250E4	ACTIVE	TSSOP	PW	14	250	Green (RoHS & no Sb/Br)	CU NIPDAU	Level-3-260C-168 HR
OPA4243EA/2K5	ACTIVE	TSSOP	PW	14	2500	Green (RoHS & no Sb/Br)	CU NIPDAU	Level-3-260C-168 HR
OPA4243EA/2K5E4	ACTIVE	TSSOP	PW	14	2500	Green (RoHS & no Sb/Br)	CU NIPDAU	Level-3-260C-168 HR

<sup>(1)</sup> The marketing status values are defined as follows:

**ACTIVE:** Product device recommended for new designs.

**LIFEBUY:** TI has announced that the device will be discontinued, and a lifetime-buy period is in effect.

**NRND:** Not recommended for new designs. Device is in production to support existing customers, but TI does not recommend using this part in a new design.

**PREVIEW:** Device has been announced but is not in production. Samples may or may not be available.

**OBSOLETE:** TI has discontinued the production of the device.

<sup>(2)</sup> Eco Plan - The planned eco-friendly classification: Pb-Free (RoHS), Pb-Free (RoHS Exempt), or Green (RoHS & no Sb/Br) - please check <http://www.ti.com/productcontent> for the latest availability information and additional product content details.

**TBD:** The Pb-Free/Green conversion plan has not been defined.

**Pb-Free (RoHS):** TI's terms "Lead-Free" or "Pb-Free" mean semiconductor products that are compatible with the current RoHS requirements for all 6 substances, including the requirement that lead not exceed 0.1% by weight in homogeneous materials. Where designed to be soldered at high temperatures, TI Pb-Free products are suitable for use in specified lead-free processes.

**Pb-Free (RoHS Exempt):** This component has a RoHS exemption for either 1) lead-based flip-chip solder bumps used between the die and package, or 2) lead-based die adhesive used between the die and leadframe. The component is otherwise considered Pb-Free (RoHS compatible) as defined above.

**Green (RoHS & no Sb/Br):** TI defines "Green" to mean Pb-Free (RoHS compatible), and free of Bromine (Br) and Antimony (Sb) based flame retardants (Br or Sb do not exceed 0.1% by weight in homogeneous material)

<sup>(3)</sup> MSL, Peak Temp. -- The Moisture Sensitivity Level rating according to the JEDEC industry standard classifications, and peak solder temperature.

**Important Information and Disclaimer:**The information provided on this page represents TI's knowledge and belief as of the date that it is provided. TI bases its knowledge and belief on information provided by third parties, and makes no representation or warranty as to the accuracy of such information. Efforts are underway to better integrate information from third parties. TI has taken and continues to take reasonable steps to provide representative and accurate information but may not have conducted destructive testing or chemical analysis on incoming materials and chemicals. TI and TI suppliers consider certain information to be proprietary, and thus CAS numbers and other limited information may not be available for release.

In no event shall TI's liability arising out of such information exceed the total purchase price of the TI part(s) at issue in this document sold by TI to Customer on an annual basis.

**TAPE AND REEL INFORMATION**



**QUADRANT ASSIGNMENTS FOR PIN 1 ORIENTATION IN TAPE**



\*All dimensions are nominal

Device	Package Type	Package Drawing	Pins	SPQ	Reel Diameter (mm)	Reel Width W1 (mm)	A0 (mm)	B0 (mm)	K0 (mm)	P1 (mm)	W (mm)	Pin1 Quadrant
OPA4243EA/250	TSSOP	PW	14	250	180.0	12.4	7.0	5.6	1.6	8.0	12.0	Q1
OPA4243EA/2K5	TSSOP	PW	14	2500	330.0	12.4	7.0	5.6	1.6	8.0	12.0	Q1

**TAPE AND REEL BOX DIMENSIONS**



\*All dimensions are nominal

Device	Package Type	Package Drawing	Pins	SPQ	Length (mm)	Width (mm)	Height (mm)
OPA4243EA/250	TSSOP	PW	14	250	190.5	212.7	31.8
OPA4243EA/2K5	TSSOP	PW	14	2500	346.0	346.0	29.0

## IMPORTANT NOTICE

Texas Instruments Incorporated and its subsidiaries (TI) reserve the right to make corrections, modifications, enhancements, improvements, and other changes to its products and services at any time and to discontinue any product or service without notice. Customers should obtain the latest relevant information before placing orders and should verify that such information is current and complete. All products are sold subject to TI's terms and conditions of sale supplied at the time of order acknowledgment.

TI warrants performance of its hardware products to the specifications applicable at the time of sale in accordance with TI's standard warranty. Testing and other quality control techniques are used to the extent TI deems necessary to support this warranty. Except where mandated by government requirements, testing of all parameters of each product is not necessarily performed.

TI assumes no liability for applications assistance or customer product design. Customers are responsible for their products and applications using TI components. To minimize the risks associated with customer products and applications, customers should provide adequate design and operating safeguards.

TI does not warrant or represent that any license, either express or implied, is granted under any TI patent right, copyright, mask work right, or other TI intellectual property right relating to any combination, machine, or process in which TI products or services are used. Information published by TI regarding third-party products or services does not constitute a license from TI to use such products or services or a warranty or endorsement thereof. Use of such information may require a license from a third party under the patents or other intellectual property of the third party, or a license from TI under the patents or other intellectual property of TI.

Reproduction of TI information in TI data books or data sheets is permissible only if reproduction is without alteration and is accompanied by all associated warranties, conditions, limitations, and notices. Reproduction of this information with alteration is an unfair and deceptive business practice. TI is not responsible or liable for such altered documentation. Information of third parties may be subject to additional restrictions.

Resale of TI products or services with statements different from or beyond the parameters stated by TI for that product or service voids all express and any implied warranties for the associated TI product or service and is an unfair and deceptive business practice. TI is not responsible or liable for any such statements.

TI products are not authorized for use in safety-critical applications (such as life support) where a failure of the TI product would reasonably be expected to cause severe personal injury or death, unless officers of the parties have executed an agreement specifically governing such use. Buyers represent that they have all necessary expertise in the safety and regulatory ramifications of their applications, and acknowledge and agree that they are solely responsible for all legal, regulatory and safety-related requirements concerning their products and any use of TI products in such safety-critical applications, notwithstanding any applications-related information or support that may be provided by TI. Further, Buyers must fully indemnify TI and its representatives against any damages arising out of the use of TI products in such safety-critical applications.

TI products are neither designed nor intended for use in military/aerospace applications or environments unless the TI products are specifically designated by TI as military-grade or "enhanced plastic." Only products designated by TI as military-grade meet military specifications. Buyers acknowledge and agree that any such use of TI products which TI has not designated as military-grade is solely at the Buyer's risk, and that they are solely responsible for compliance with all legal and regulatory requirements in connection with such use.

TI products are neither designed nor intended for use in automotive applications or environments unless the specific TI products are designated by TI as compliant with ISO/TS 16949 requirements. Buyers acknowledge and agree that, if they use any non-designated products in automotive applications, TI will not be responsible for any failure to meet such requirements.

Following are URLs where you can obtain information on other Texas Instruments products and application solutions:

### Products

Amplifiers	<a href="http://amplifier.ti.com">amplifier.ti.com</a>
Data Converters	<a href="http://dataconverter.ti.com">dataconverter.ti.com</a>
DSP	<a href="http://dsp.ti.com">dsp.ti.com</a>
Clocks and Timers	<a href="http://www.ti.com/clocks">www.ti.com/clocks</a>
Interface	<a href="http://interface.ti.com">interface.ti.com</a>
Logic	<a href="http://logic.ti.com">logic.ti.com</a>
Power Mgmt	<a href="http://power.ti.com">power.ti.com</a>
Microcontrollers	<a href="http://microcontroller.ti.com">microcontroller.ti.com</a>
RFID	<a href="http://www.ti-rfid.com">www.ti-rfid.com</a>
RF/IF and ZigBee® Solutions	<a href="http://www.ti.com/lprf">www.ti.com/lprf</a>

### Applications

Audio	<a href="http://www.ti.com/audio">www.ti.com/audio</a>
Automotive	<a href="http://www.ti.com/automotive">www.ti.com/automotive</a>
Broadband	<a href="http://www.ti.com/broadband">www.ti.com/broadband</a>
Digital Control	<a href="http://www.ti.com/digitalcontrol">www.ti.com/digitalcontrol</a>
Medical	<a href="http://www.ti.com/medical">www.ti.com/medical</a>
Military	<a href="http://www.ti.com/military">www.ti.com/military</a>
Optical Networking	<a href="http://www.ti.com/opticalnetwork">www.ti.com/opticalnetwork</a>
Security	<a href="http://www.ti.com/security">www.ti.com/security</a>
Telephony	<a href="http://www.ti.com/telephony">www.ti.com/telephony</a>
Video & Imaging	<a href="http://www.ti.com/video">www.ti.com/video</a>
Wireless	<a href="http://www.ti.com/wireless">www.ti.com/wireless</a>

Mailing Address: Texas Instruments, Post Office Box 655303, Dallas, Texas 75265  
Copyright © 2008, Texas Instruments Incorporated