



16-Bit, 500kHz, MicroPower Sampling ANALOG-TO-DIGITAL CONVERTER

Check for Samples: [ADS8322](#)

FEATURES

- HIGH-SPEED PARALLEL INTERFACE
- 500kHz SAMPLING RATE
- LOW POWER: 85mW at 500kHz
- INTERNAL 2.5V REFERENCE
- UNIPOLAR INPUT RANGE
- TQFP-32 PACKAGE

APPLICATIONS

- CT SCANNERS
- HIGH-SPEED DATA ACQUISITION
- TEST AND INSTRUMENTATION
- MEDICAL EQUIPMENT

DESCRIPTION

The ADS8322 is a 16-bit, 500kHz analog-to-digital (A/D) converter with an internal 2.5V reference. The device includes a 16-bit capacitor-based successive approximation register (SAR) A/D converter with inherent sample-and-hold. The ADS8322 offers a full 16-bit interface, or an 8-bit option where data are read using two read cycles and eight pins. The ADS8322 is available in a TQFP-32 package and is ensured over the industrial -40°C to $+85^{\circ}\text{C}$ temperature range.

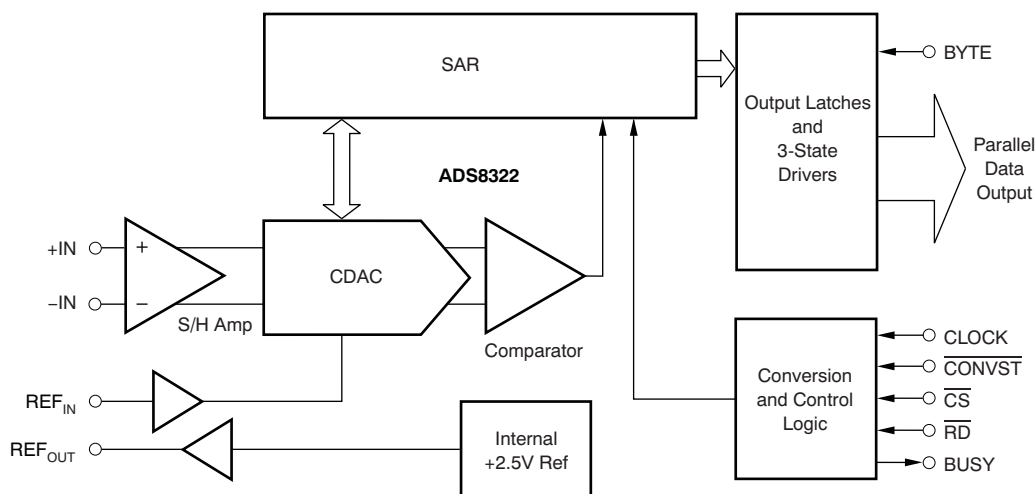

Please be aware that an important notice concerning availability, standard warranty, and use in critical applications of Texas Instruments semiconductor products and disclaimers thereto appears at the end of this data sheet.

All trademarks are the property of their respective owners.



This integrated circuit can be damaged by ESD. Texas Instruments recommends that all integrated circuits be handled with appropriate precautions. Failure to observe proper handling and installation procedures can cause damage.

ESD damage can range from subtle performance degradation to complete device failure. Precision integrated circuits may be more susceptible to damage because very small parametric changes could cause the device not to meet its published specifications.

ORDERING INFORMATION⁽¹⁾

PRODUCT	MAXIMUM INTEGRAL LINEARITY ERROR (LSB)	NO MISSING CODES ERROR (LSB)	PACKAGE-LEAD	PACKAGE DESIGNATOR	SPECIFIED TEMPERATURE RANGE	PACKAGE MARKING	TRANSPORT MEDIA, QUANTITY
ADS8322Y	±8	14	TQFP-32	PBS	-40°C to +85°C		Tape and reel, 250
							Tape and reel, 2000
ADS8322YB	±6	15	TQFP-32	PBS	-40°C to +85°C		Tape and reel, 250
							Tape and reel, 2000

(1) For the most current package and ordering information, see the Package Option Addendum at the end of this data sheet, or see the TI website at www.ti.com.

ABSOLUTE MAXIMUM RATINGS⁽¹⁾

Over operating free-air temperature range (unless otherwise noted).

	ADS8322	UNIT
+IN to GND	$V_A + 0.1$	V
-IN to GND	+0.5	V
V_A to GND	-0.3 to +7	V
Digital input voltage to GND	-0.3 to ($V_A + 0.3$)	V
V_{OUT} to GND	-0.3 to ($V_A + 0.3$)	V
Operating temperature range	-40 to +105	°C
Storage temperature range	-65 to +150	°C
Junction temperature (T_J max)	+150	°C
Power dissipation	$(T_J \text{ max} - T_A)/\theta_{JA}$	
θ_{JA} thermal impedance	240	°C/W

(1) Stresses above those listed under *Absolute Maximum Ratings* may cause permanent damage to the device. Exposure to absolute maximum conditions for extended periods may affect device reliability.

ELECTRICAL CHARACTERISTICS: +V_A = +5V

 At –40°C to +85°C, +V_A = +5V, V_{REF} = +2.5V, f_{SAMPLE} = 500kHz, and f_{CLK} = 20 • f_{SAMPLE}, unless otherwise specified.

PARAMETER	TEST CONDITIONS	ADS8322Y			ADS8322YB ⁽¹⁾			UNIT
		MIN	TYP	MAX	MIN	TYP	MAX	
RESOLUTION								
Resolution			16			16		Bits
ANALOG INPUTS								
Full-scale input span ⁽²⁾	+IN – (–IN)	0		+2V _{REF}	0		+2V _{REF}	V
Absolute input range	+IN	–0.1		V _A + 0.1	–0.1		V _A + 0.1	V
	–IN	–0.1		+0.5	–0.1		+0.5	V
Capacitance			25			25		pF
Leakage current			±1			±1		nA
SYSTEM PERFORMANCE								
No missing codes		14			15			Bits
Integral linearity error			±4	±8		±3	±6	LSBs ⁽³⁾
Offset error			±1.0	±2		±0.5	±1.0	mV
Gain error ⁽⁴⁾			±0.25	±0.50		±0.22	±0.25	%FSR
Common-mode rejection ratio	At dc		70			70		dB
Noise			60			60		μV _{RMS}
Power-supply rejection ratio	At FFFFh output code		±3			±3		LSBs
SAMPLING DYNAMICS								
Conversion time				1.6			1.6	μs
Acquisition time		350			350			ns
Throughput rate				500			500	kHz
Aperture delay			50			50		ns
Aperture jitter			20			20		ps
Small-signal bandwidth			30			30		MHz
Step response			100			100		ns
DYNAMIC CHARACTERISTICS								
Total harmonic distortion ⁽⁵⁾	V _{IN} = 5V _{PP} at 100kHz		–90			–93		dB
SINAD	V _{IN} = 5V _{PP} at 100kHz		81			83		dB
Spurious free dynamic range	V _{IN} = 5V _{PP} at 100kHz		94			96		dB
REFERENCE OUTPUT								
Voltage	I _{OUT} = 0	2.475	2.50	2.525	2.48	2.50	2.52	V
Source current	Static load			10			10	μA
Drift	I _{OUT} = 0		20			20		ppm/°C
Line regulation	4.75V ≤ V _{CC} ≤ 5.25V		0.6			0.6		mV
REFERENCE INPUT								
Range		1.5		2.55	1.5		2.55	V
Resistance ⁽⁶⁾	To internal reference voltage		10			10		kΩ

(1) Shaded cells indicate different specifications from ADS8322Y.

(2) Ideal input span; does not include gain or offset error.

 (3) LSB means least significant bit, with V_{REF} equal to +2.5V; 1LSB = 76μV.

(4) Measured relative to an ideal, full-scale input [+In – (–In)] of 4.9999V. Thus, gain error includes the error of the internal voltage reference.

(5) Calculated on the first nine harmonics of the input frequency.

(6) Can vary ±30%.

ELECTRICAL CHARACTERISTICS: +V_A = +5V (continued)

At -40°C to +85°C, +V_A = +5V, V_{REF} = +2.5V, f_{SAMPLE} = 500kHz, and f_{CLK} = 20 • f_{SAMPLE}, unless otherwise specified.

PARAMETER	TEST CONDITIONS	ADS8322Y			ADS8322YB ⁽¹⁾			UNIT
		MIN	TYP	MAX	MIN	TYP	MAX	
DIGITAL INPUT/OUTPUT								
Logic family			CMOS			CMOS		
Logic levels:								
V _{IH}	I _{IH} ≤ +5μA	3.0		+V _A	3.0		+V _A	V
V _{IL}	I _{IL} ≤ +5μA	-0.3		0.8	-0.3		0.8	V
V _{OH}	I _{OH} = 2 TTL Loads	4.0			4.0			V
V _{OL}	I _{OH} = 2 TTL Loads			0.4			0.4	V
Data format		Straight binary			Straight binary			
POWER-SUPPLY REQUIREMENTS								
Power-supply voltage								
+V _A		4.75	5	5.25	4.75	5	5.25	V
+V _D		4.75	5	5.25	4.75	5	5.25	V
Supply current	f _{SAMPLE} = 500kHz		17	25		17	25	mA
Power dissipation	f _{SAMPLE} = 500kHz		85	125		85	125	mW
TEMPERATURE RANGE								
Specified temperature range		-40		+85	-40		+85	°C

DEVICE INFORMATION

**PBS PACKAGE
TQFP-32
(TOP VIEW)**

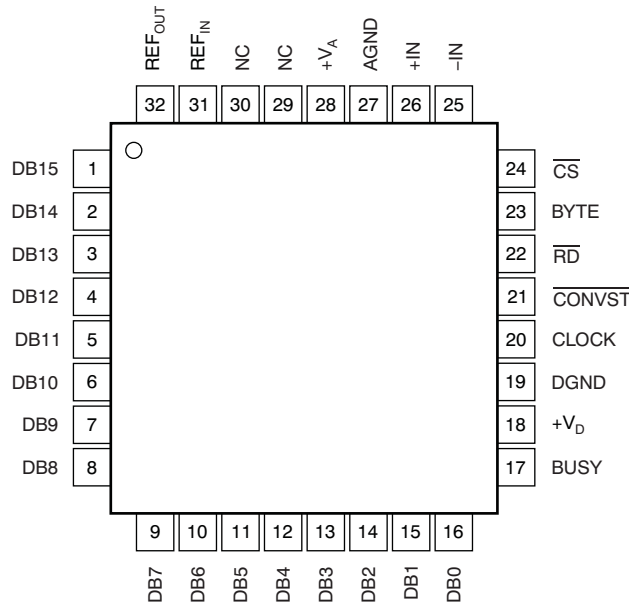

PIN ASSIGNMENTS

TERMINAL		DESCRIPTION
NO	NAME	
1	DB15	Data Bit 15 (MSB)
2	DB14	Data Bit 14
3	DB13	Data Bit 13
4	DB12	Data Bit 12
5	DB11	Data Bit 11
6	DB10	Data Bit 10
7	DB9	Data Bit 9
8	DB8	Data Bit 8
9	DB7	Data Bit 7
10	DB6	Data Bit 6
11	DB5	Data Bit 5
12	DB4	Data Bit 4
13	DB3	Data Bit 3
14	DB2	Data Bit 2
15	DB1	Data Bit 1
16	DB0	Data Bit 0 (LSB)
17	BUSY	High when a conversion is in progress.
18	V _D +	Digital Power Supply, +5VDC.
19	DGND	Digital Ground
20	CLOCK	An external CMOS-compatible clock can be applied to the CLOCK input to synchronize the conversion process to an external source.
21	$\overline{\text{CONVST}}$	Convert Start
22	$\overline{\text{RD}}$	Synchronization pulse for the parallel output.
23	BYTE	Selects eight most significant bits (low) or eight least significant bits (high). Data valid on pins 9-16.
24	$\overline{\text{CS}}$	Chip Select
25	-IN	Inverting Input Channel
26	+IN	Noninverting Input Channel
27	AGND	Analog Ground
28	+V _A	Analog Power Supply, +5VDC.
29	NC	No connection
30	NC	No connection
31	REF _{IN}	Reference Input. When using the internal 2.5V reference, tie this pin directly to REF _{OUT} .
32	REF _{OUT}	Reference Output. A 0.1μF capacitor should be connected to this pin when the internal reference is used.

TIMING INFORMATION

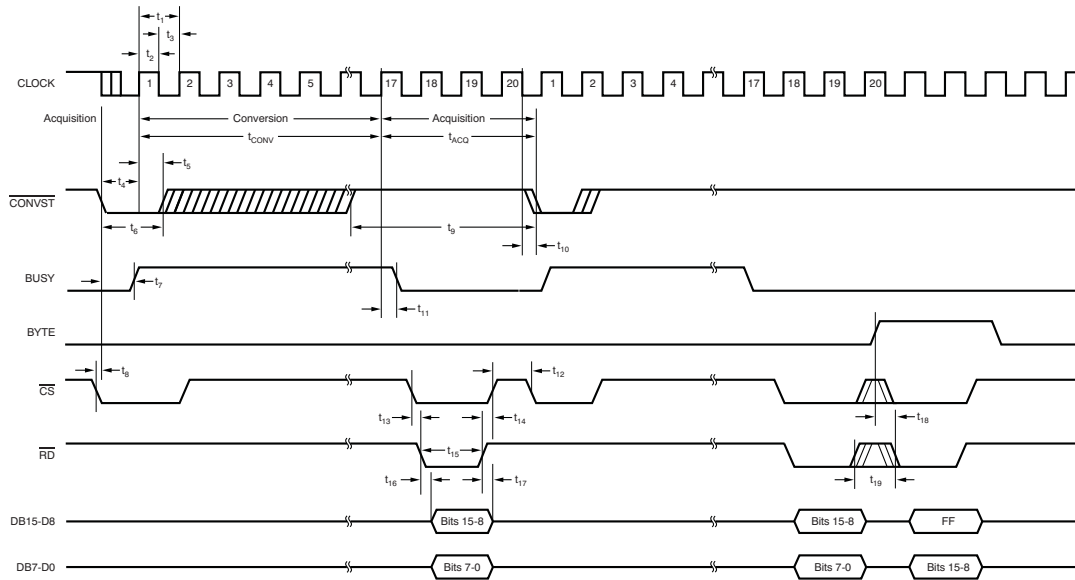

TIMING CHARACTERISTICS⁽¹⁾⁽²⁾

All specifications typical at -40°C to $+85^{\circ}\text{C}$, $+V_D = +5\text{V}$.

PARAMETER	TEST CONDITIONS	ADS8322			UNIT
		MIN	TYP	MAX	
t_{CONV}	Conversion Time			1.6	μs
t_{AOC}	Acquisition Time	350			ns
t_1	CLOCK Period	100			ns
t_2	CLOCK High Time	40			ns
t_3	CLOCK Low Time	40			ns
t_4	CONVST Low to Clock High	10			ns
t_5	CLOCK High to CONVST High	5			ns
t_6	CONVST Low Time	20			ns
t_7	CONVST Low to BUSY High			25	ns
t_8	CS Low to CONVST Low	0			ns
t_9	CONVST High	20			ns
t_{10}	CLOCK Low to CONVST Low	0			ns
t_{11}	CLOCK High to BUSY Low			25	ns
t_{12}	CS High	0			ns
t_{13}	CS Low to RD Low	0			ns
t_{14}	RD High to CS High	0			ns
t_{15}	RD Low Time	50			ns
t_{16}	RD Low to Data Valid	40			ns
t_{17}	Data Hold from RD High	5			ns
t_{18}	BYTE Change to RD Low ⁽³⁾	0			ns
t_{19}	RD High Time	20			ns

- (1) All input signals are specified with $t_R = t_F = 5\text{ns}$ (10% to 90% of V_{DD}) and timed from a voltage level of $(V_{IL} + V_{IH}) / 2$.
- (2) See timing diagram, above.
- (3) BYTE is asynchronous; when BYTE is 0, bits 15 through 0 appear at DB15-DB0. When BUSY is 1, bits 15 through 8 appear on DB7-DB0. RD may remain low between changes in BYTE.

TYPICAL CHARACTERISTICS

At -40°C to $+85^{\circ}\text{C}$, $+V_A = +5\text{V}$, $V_{\text{REF}} = +2.5\text{V}$, $f_{\text{SAMPLE}} = 500\text{kHz}$, and $f_{\text{CLK}} = 20 \cdot f_{\text{SAMPLE}}$, unless otherwise specified.

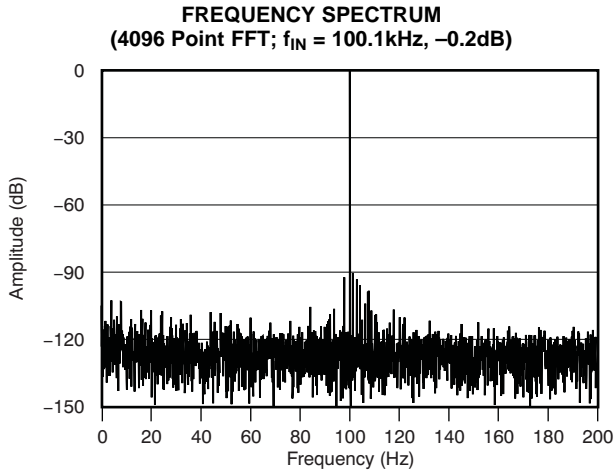

Figure 1.

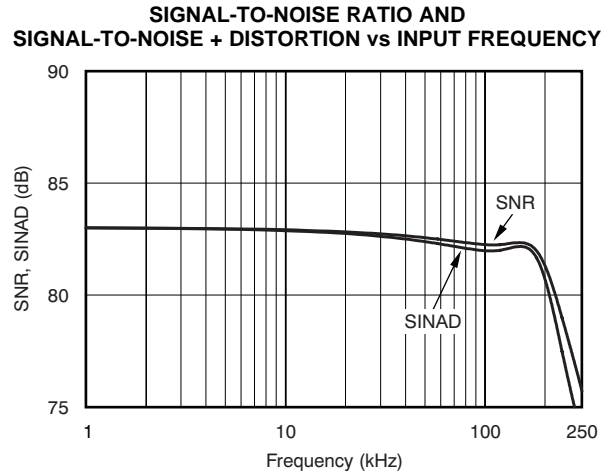

Figure 2.

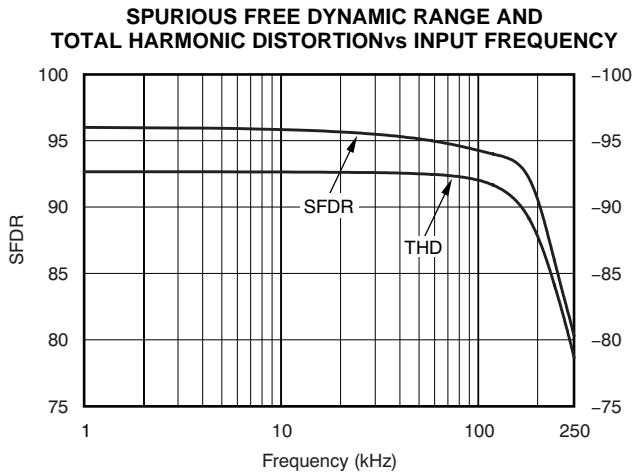

Figure 3.

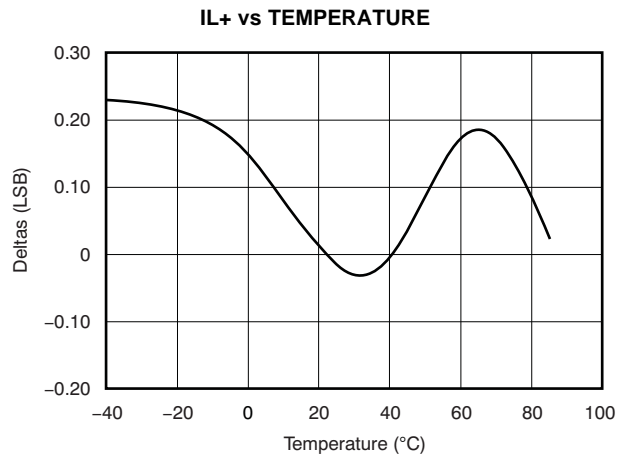

Figure 4.

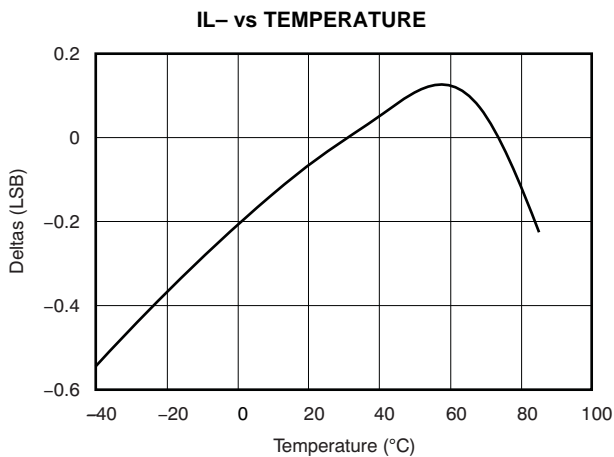

Figure 5.

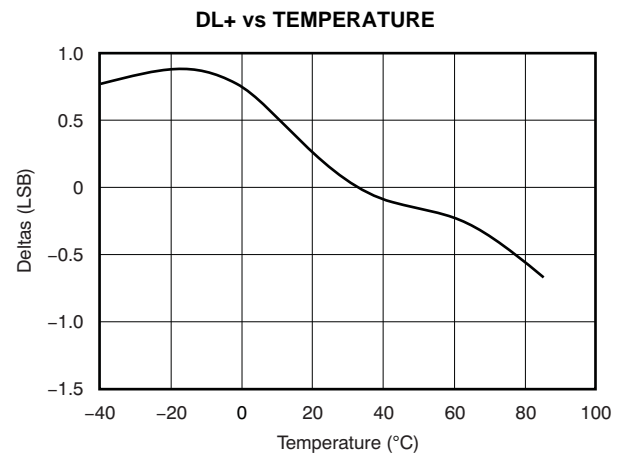

Figure 6.

TYPICAL CHARACTERISTICS (continued)

At -40°C to $+85^{\circ}\text{C}$, $+V_A = +5\text{V}$, $V_{\text{REF}} = +2.5\text{V}$, $f_{\text{SAMPLE}} = 500\text{kHz}$, and $f_{\text{CLK}} = 20 \cdot f_{\text{SAMPLE}}$, unless otherwise specified.

DL- vs TEMPERATURE

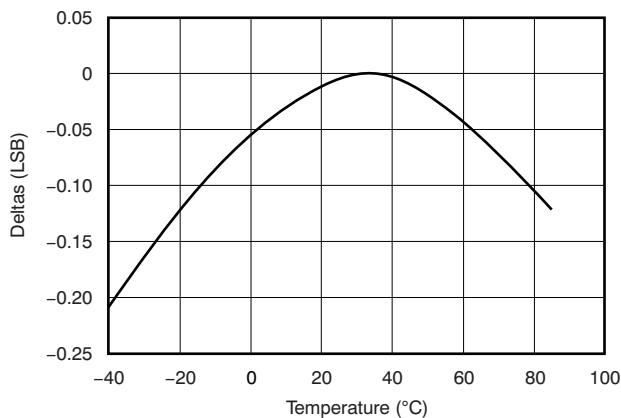

Figure 7.

OFFSET ERROR vs TEMPERATURE

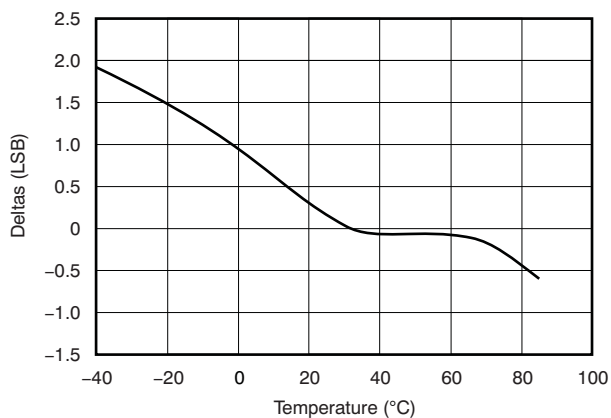

Figure 8.

GAIN ERROR vs TEMPERATURE

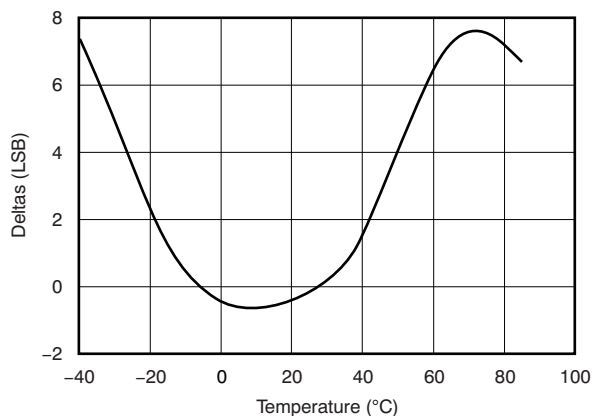

Figure 9.

V_{REF} vs TEMPERATURE

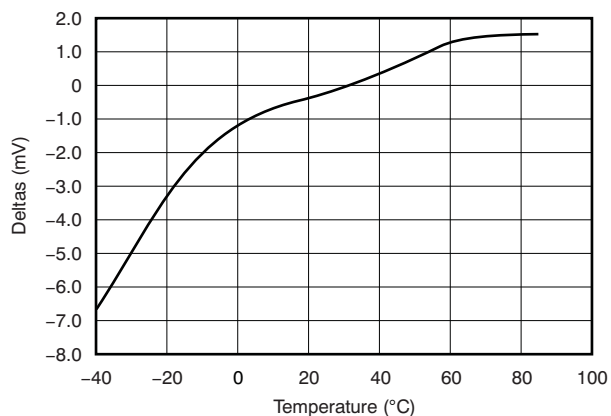

Figure 10.

I_Q vs TEMPERATURE

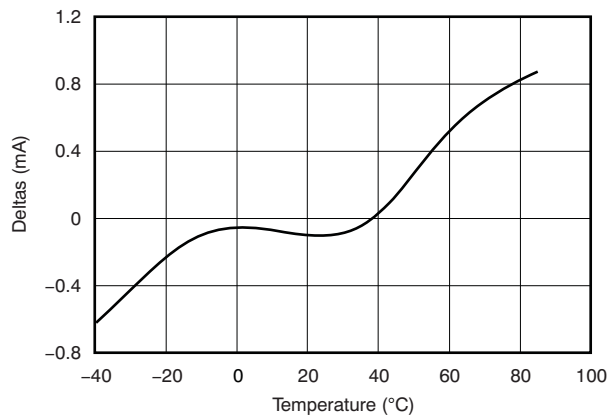

Figure 11.

LINEARITY ERROR AND DIFFERENTIAL LINEARITY ERROR vs CODE

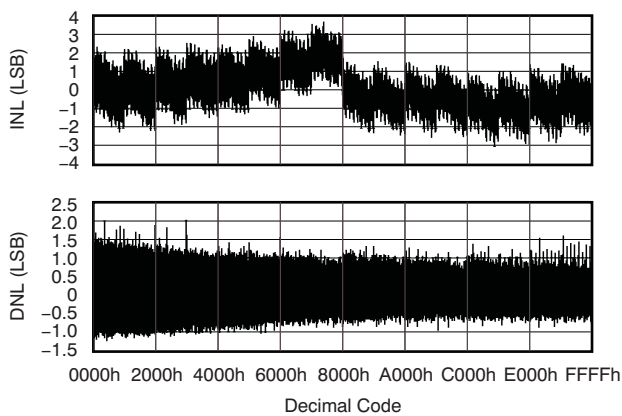

Figure 12.

THEORY OF OPERATION

The ADS8322 is a high-speed successive approximation register (SAR) A/D converter with an internal 2.5V bandgap reference. The architecture is based on capacitive redistribution, which inherently includes a sample-and-hold function. The basic operating circuit for the ADS8322 is shown in Figure 13.

The ADS8322 requires an external clock to run the conversion process. The clock can be run continuously or it can be gated to conserve power between conversions. This clock can vary between 25kHz (1.25kHz throughput) and 10MHz (500kHz throughput). The duty cycle of the clock is unimportant as long as the minimum HIGH and LOW

times are at least 40ns and the clock period is at least 100ns. The minimum clock frequency is governed by the parasitic leakage of the capacitive digital-to-analog (CDAC) capacitors internal to the ADS8322.

The analog input is provided to two input pins, +IN and -IN. When a conversion is initiated, the differential input on these pins is sampled on the internal capacitor array. While a conversion is in progress, both inputs are disconnected from any internal function.

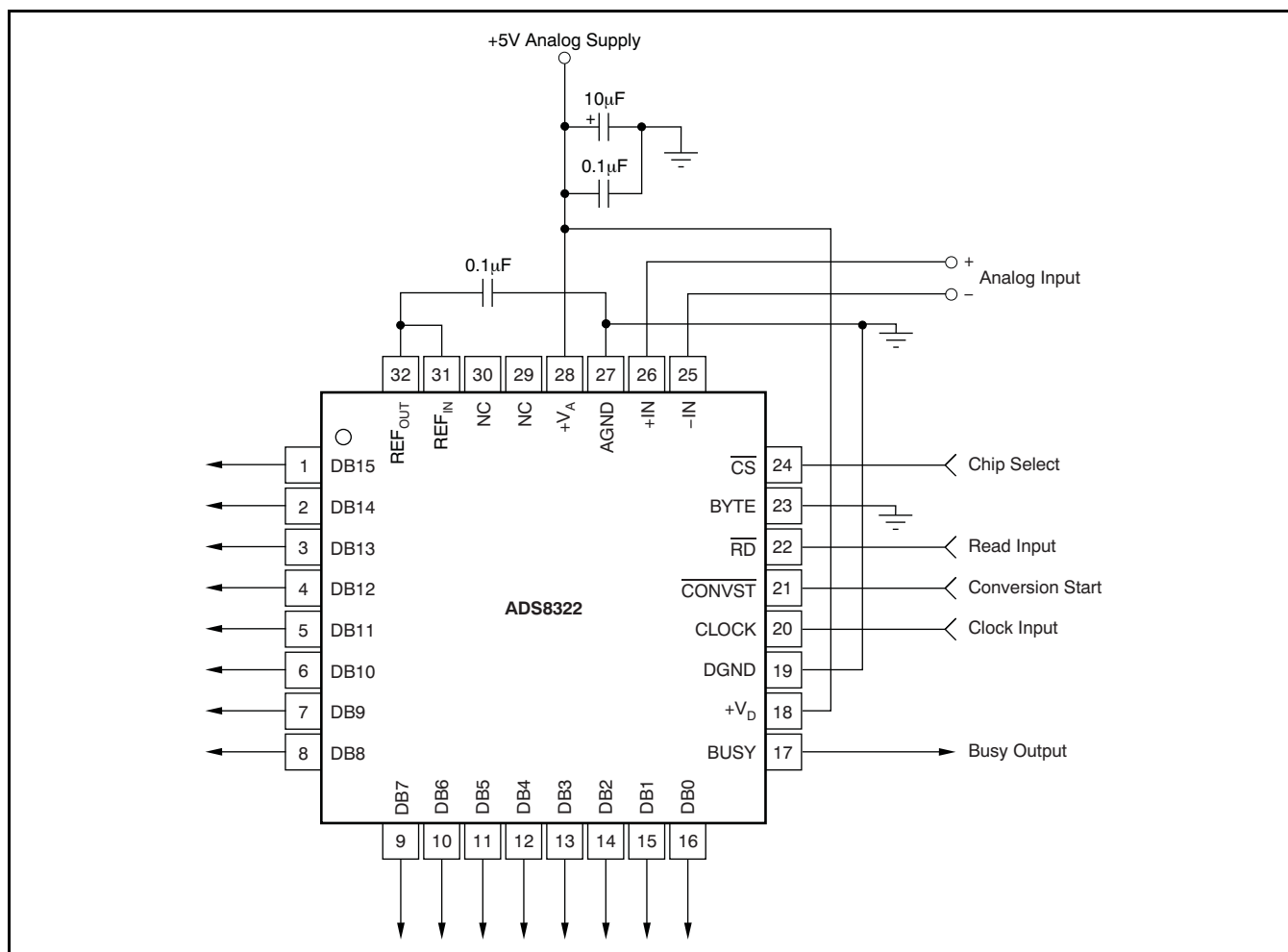

Figure 13. Typical Circuit Configuration

REFERENCE

Under normal operation, the REF_{OUT} pin should be directly connected to the REF_{IN} pin to provide an internal +2.5V reference to the ADS8322. The ADS8322 can operate, however, with an external reference in the range of 1.5V to 2.6V for a corresponding full-scale range of 3.0V to 5.2V.

The internal reference of the ADS8322 is double-buffered. If the internal reference is used to drive an external load, a buffer is provided between the reference and the load applied to the REF_{OUT} pin (the internal reference can typically source and sink 10µA of current). If an external reference is used, the second buffer provides isolation between the external reference and the CDAC. This buffer is also used to recharge all of the CDAC capacitors during conversion.

ANALOG INPUT

When the converter enters the Hold mode, the voltage difference between the +IN and –IN inputs is captured on the internal capacitor array. The voltage on the –IN input is limited between –0.1V and 0.5V, allowing the input to reject small signals which are common to both the +IN and –IN inputs. The +IN input has a range of –0.1V to +V_A + 0.1V.

The input current on the analog inputs depends upon a number of factors: sample rate, input voltage, and source impedance. Essentially, the current into the ADS8322 charges the internal capacitor array during the sample period. After this capacitance has been fully charged, there is no further input current. The source of the analog input voltage must be able to charge the input capacitance (25pF) to a 16-bit settling level within the acquisition time (400ns) of the device. When the converter goes into Hold mode, the input impedance is greater than 1GΩ.

Care must be taken regarding the absolute analog input voltage. To maintain the linearity of the converter, the –IN input should not drop below GND – 100mV or exceed GND + 0.5V. The +IN input should always remain within the range of GND – 100mV to V_A + 100mV. Outside of these ranges, the converter linearity may not meet specifications. To minimize noise, low-bandwidth input signals with low-pass filters should be used.

DIGITAL INTERFACE

TIMING AND CONTROL

See the [timing diagram](#) and the [Timing Characteristics](#) section for detailed information on timing signals and the respective requirements for each.

The ADS8322 uses an external clock (CLOCK) which controls the conversion rate of the CDAC. With a 10MHz external clock, the A/D converter sampling rate is 500kHz, which corresponds to a 2µs maximum throughput time.

Conversions are initiated by bringing the CONVST pin low for a minimum of 20ns (after the 20ns minimum requirement has been met, the CONVST pin can be brought high), while CS is low. The ADS8322 switches from Sample-to-Hold mode on the falling edge of the CONVST command. Following the first rising edge of the external clock after a CONVST low, the ADS8322 begins conversion (this first rising edge of the external clock represents the start of clock cycle one; the ADS8322 requires 16 rising clock edges to complete a conversion). The BUSY output goes high immediately following CONVST going low. BUSY stays high through the conversion process and returns low when the conversion has ended.

Both RD and CS can be high during and before a conversion (although CS must be low when CONVST goes low to initiate a conversion). Both the RD and CS pins are brought low in order to enable the parallel output bus with the conversion.

READING DATA

The ADS8322 outputs full parallel data in Straight Binary format, as shown in [Table 1](#). The parallel output is active when CS and RD are both LOW. The output data should not be read 125ns before the falling edge of CONVST and 10ns after the falling edge. Any other combination of CS and RD will 3-state the parallel output. Refer to [Table 1](#) for ideal output codes.

Table 1. Ideal Input Voltages and Output Codes

DESCRIPTION	ANALOG VALUE	DIGITAL OUTPUT STRAIGHT BINARY	
		BINARY CODE	HEX CODE
Full-Scale Range	$2 \cdot V_{REF}$		
Least Significant Bit (LSB)	$2 \cdot V_{REF}/65535$		
+Full Scale	$2V_{REF} - 1 \text{ LSB}$	1111 1111 1111 1111	FFFF
Midscale	V_{REF}	1000 0000 0000 0000	8000
Midscale – LSB	$V_{REF} - 1 \text{ LSB}$	0111 1111 1111 1111	7FFF
Zero	0	0000 0000 0000 0000	0000

BYTE

The output data appear as a full 16-bit word on DB15- DB0 (MSB-LSB), if BYTE is low. The result may also be read on an 8-bit bus by using only DB7-DB0. In this case two reads are necessary. The first read proceeds as before, leaving BYTE low and reading the eight least significant bits on DB7-DB0, then bringing BYTE high. When BYTE is high, the upper eight bits (D15-D8) appear on DB7-DB0.

NOISE

Figure 14 shows the transition noise of the ADS8322. A low-level dc input was applied to the analog input pins and the converter was put through 8,192 conversions. The digital output of the A/D converter varies in output code due to the internal noise of the ADS8322. This characteristic is true for all 16-bit SAR-type A/D converters. Using a histogram to plot the output codes, the distribution should appear bell-shaped, with the peak of the bell curve representing the nominal code for the input value. The $\pm 1\sigma$, $\pm 2\sigma$, and $\pm 3\sigma$ distributions respectively represent the 68.3%, 95.5%, and 99.7% of all codes. The transition noise can be calculated by dividing the number of codes measured by six; this yields the $\pm 3\sigma$ distribution, or 99.7%, of all codes. Statistically, up to three codes could fall outside the distribution when executing 1,000 conversions. The ADS8322, with five output codes for the $\pm 3\sigma$ distribution, yields a $< \pm 0.8\text{LSB}$ transition noise at 5V operation. Remember that to achieve this low-noise performance, the peak-to-peak noise of the input signal and reference must be $< 50\mu\text{V}$.

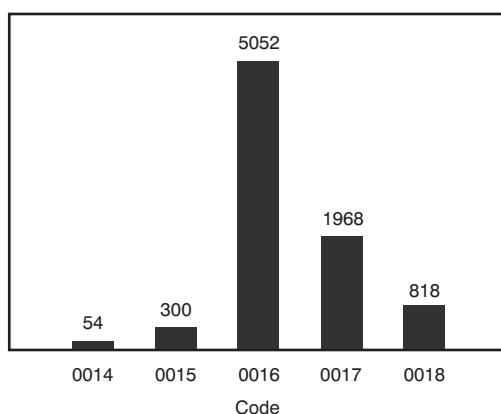

Figure 14. Histogram of 8,192 Conversions of a Low-Level DC Input

AVERAGING

The noise of the A/D converter can be compensated by averaging the digital codes. By averaging conversion results, transition noise is reduced by a factor of $1/\sqrt{n}$, where n is the number of averages. For example, averaging four conversion results reduces the transition noise by 1/2 to $\pm 0.25\text{LSBs}$. Averaging should only be used for input signals with frequencies near dc.

For ac signals, a digital filter can be used to low-pass filter and decimate the output codes. This configuration works in a similar manner to averaging: for every decimation by 2, the signal-to-noise ratio improves by 3dB.

LAYOUT

For optimum performance, care should be taken with the physical layout of the ADS8322 circuitry. This consideration is particularly true if the CLOCK input is approaching the maximum throughput rate.

As the ADS8322 offers single-supply operation, it is often used in close proximity with digital logic, microcontrollers, microprocessors, and digital signal processors. The more digital logic present in the design and the higher the switching speed, the more difficult it is to achieve good performance from the converter.

The basic SAR architecture is sensitive to glitches or sudden changes on the power supply, reference, ground connections and digital inputs that occur just before latching the output of the analog comparator. Thus, during any single conversion for an n -bit SAR converter, there are n windows in which large external transient voltages can affect the conversion result. Such glitches might originate from switching power supplies, or nearby digital logic or high-power devices.

The degree of error in the digital output depends on the reference voltage, layout, and the exact timing of the external event. These errors can change if the external event changes in time with respect to the CLOCK input.

On average, the ADS8322 draws very little current from an external reference, as the reference voltage is internally buffered. If the reference voltage is external and originates from an op amp, make sure that it can drive the bypass capacitor or capacitors without oscillation.

The AGND and DGND pins should be connected to a clean ground point. In all cases, this point should be the *analog* ground. Avoid connections which are too close to the grounding point of a microcontroller or digital signal processor. If required, run a ground trace directly from the converter to the power supply entry point. The ideal layout will include an analog ground plane dedicated to the converter and associated analog circuitry.

As with the GND connections, V_{DD} should be connected to a +5V power supply plane, or trace, that is separate from the connection for digital logic until they are connected at the power entry point. Power to the ADS8322 should be clean and well-bypassed. A 0.1µF ceramic bypass capacitor should be placed as close to the device as possible. In addition, a 1µF to 10µF capacitor is recommended. If needed, an even larger capacitor and a 5Ω or 10Ω series resistor may be used to low-pass filter a noisy supply. In some situations, additional bypassing may be required, such as a 100µF electrolytic capacitor, or even a *Pi* filter made up of inductors and capacitors—all designed to essentially low-pass filter the +5V supply, removing the high-frequency noise.

REVISION HISTORY

NOTE: Page numbers for previous revisions may differ from page numbers in the current version.

Changes from Original (July, 2001) to Revision A	Page
• Updated document format to current standards	1
• Deleted <i>lead temperature</i> specifications from Absolute Maximum Ratings table	2
• Changed acquisition time specification from .4µs (max) to 350ns (min)	3
• Changed acquisition time specification from .4µs (max) to 350ns (min)	6
• Added Figure 12 , <i>Linearity Error and Differential Linearity Error vs Code</i>	8

PACKAGING INFORMATION

Orderable Device	Status ⁽¹⁾	Package Type	Package Drawing	Pins	Package Qty	Eco Plan ⁽²⁾	Lead/ Ball Finish	MSL Peak Temp ⁽³⁾	Samples (Requires Login)
ADS8322Y/250	ACTIVE	TQFP	PBS	32	250	Green (RoHS & no Sb/Br)	CU NIPDAU	Level-3-260C-168 HR	
ADS8322Y/250G4	ACTIVE	TQFP	PBS	32	250	Green (RoHS & no Sb/Br)	CU NIPDAU	Level-3-260C-168 HR	
ADS8322Y/2K	ACTIVE	TQFP	PBS	32	2000	Green (RoHS & no Sb/Br)	CU NIPDAU	Level-3-260C-168 HR	
ADS8322Y/2KG4	ACTIVE	TQFP	PBS	32	2000	Green (RoHS & no Sb/Br)	CU NIPDAU	Level-3-260C-168 HR	
ADS8322YB/250	ACTIVE	TQFP	PBS	32	250	Green (RoHS & no Sb/Br)	CU NIPDAU	Level-3-260C-168 HR	
ADS8322YB/250G4	ACTIVE	TQFP	PBS	32	250	Green (RoHS & no Sb/Br)	CU NIPDAU	Level-3-260C-168 HR	

⁽¹⁾ The marketing status values are defined as follows:

ACTIVE: Product device recommended for new designs.

LIFEBUY: TI has announced that the device will be discontinued, and a lifetime-buy period is in effect.

NRND: Not recommended for new designs. Device is in production to support existing customers, but TI does not recommend using this part in a new design.

PREVIEW: Device has been announced but is not in production. Samples may or may not be available.

OBSELETE: TI has discontinued the production of the device.

⁽²⁾ Eco Plan - The planned eco-friendly classification: Pb-Free (RoHS), Pb-Free (RoHS Exempt), or Green (RoHS & no Sb/Br) - please check <http://www.ti.com/productcontent> for the latest availability information and additional product content details.

TBD: The Pb-Free/Green conversion plan has not been defined.

Pb-Free (RoHS): TI's terms "Lead-Free" or "Pb-Free" mean semiconductor products that are compatible with the current RoHS requirements for all 6 substances, including the requirement that lead not exceed 0.1% by weight in homogeneous materials. Where designed to be soldered at high temperatures, TI Pb-Free products are suitable for use in specified lead-free processes.

Pb-Free (RoHS Exempt): This component has a RoHS exemption for either 1) lead-based flip-chip solder bumps used between the die and package, or 2) lead-based die adhesive used between the die and leadframe. The component is otherwise considered Pb-Free (RoHS compatible) as defined above.

Green (RoHS & no Sb/Br): TI defines "Green" to mean Pb-Free (RoHS compatible), and free of Bromine (Br) and Antimony (Sb) based flame retardants (Br or Sb do not exceed 0.1% by weight in homogeneous material)

⁽³⁾ MSL, Peak Temp. -- The Moisture Sensitivity Level rating according to the JEDEC industry standard classifications, and peak solder temperature.

Important Information and Disclaimer: The information provided on this page represents TI's knowledge and belief as of the date that it is provided. TI bases its knowledge and belief on information provided by third parties, and makes no representation or warranty as to the accuracy of such information. Efforts are underway to better integrate information from third parties. TI has taken and continues to take reasonable steps to provide representative and accurate information but may not have conducted destructive testing or chemical analysis on incoming materials and chemicals. TI and TI suppliers consider certain information to be proprietary, and thus CAS numbers and other limited information may not be available for release.

In no event shall TI's liability arising out of such information exceed the total purchase price of the TI part(s) at issue in this document sold by TI to Customer on an annual basis.

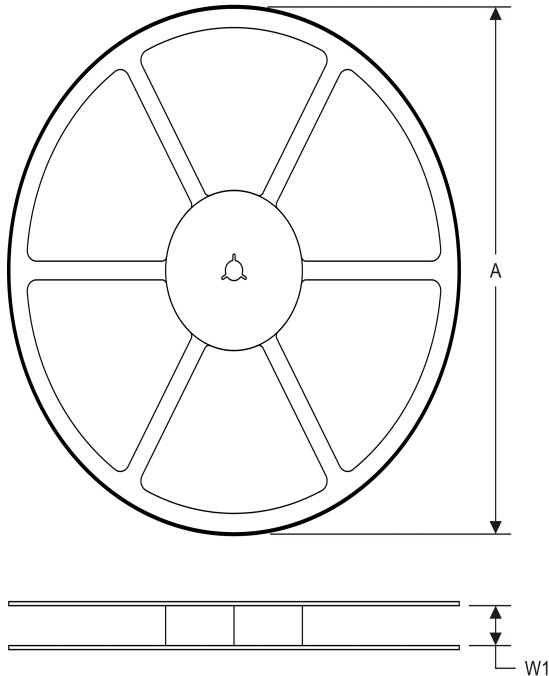
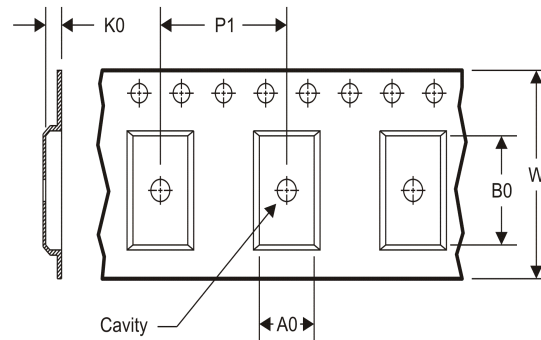
TAPE AND REEL INFORMATION
REEL DIMENSIONS

TAPE DIMENSIONS

A0	Dimension designed to accommodate the component width
B0	Dimension designed to accommodate the component length
K0	Dimension designed to accommodate the component thickness
W	Overall width of the carrier tape
P1	Pitch between successive cavity centers

TAPE AND REEL INFORMATION

*All dimensions are nominal

Device	Package Type	Package Drawing	Pins	SPQ	Reel Diameter (mm)	Reel Width W1 (mm)	A0 (mm)	B0 (mm)	K0 (mm)	P1 (mm)	W (mm)	Pin1 Quadrant
ADS8322Y/250	TQFP	PBS	32	250	330.0	16.4	7.2	7.2	1.5	12.0	16.0	Q2
ADS8322Y/2K	TQFP	PBS	32	2000	330.0	16.4	7.2	7.2	1.5	12.0	16.0	Q2
ADS8322YB/250	TQFP	PBS	32	250	330.0	16.4	7.2	7.2	1.5	12.0	16.0	Q2

TAPE AND REEL BOX DIMENSIONS

*All dimensions are nominal

Device	Package Type	Package Drawing	Pins	SPQ	Length (mm)	Width (mm)	Height (mm)
ADS8322Y/250	TQFP	PBS	32	250	367.0	367.0	38.0
ADS8322Y/2K	TQFP	PBS	32	2000	367.0	367.0	38.0
ADS8322YB/250	TQFP	PBS	32	250	367.0	367.0	38.0

PBS (S-PQFP-G32)

PLASTIC QUAD FLATPACK

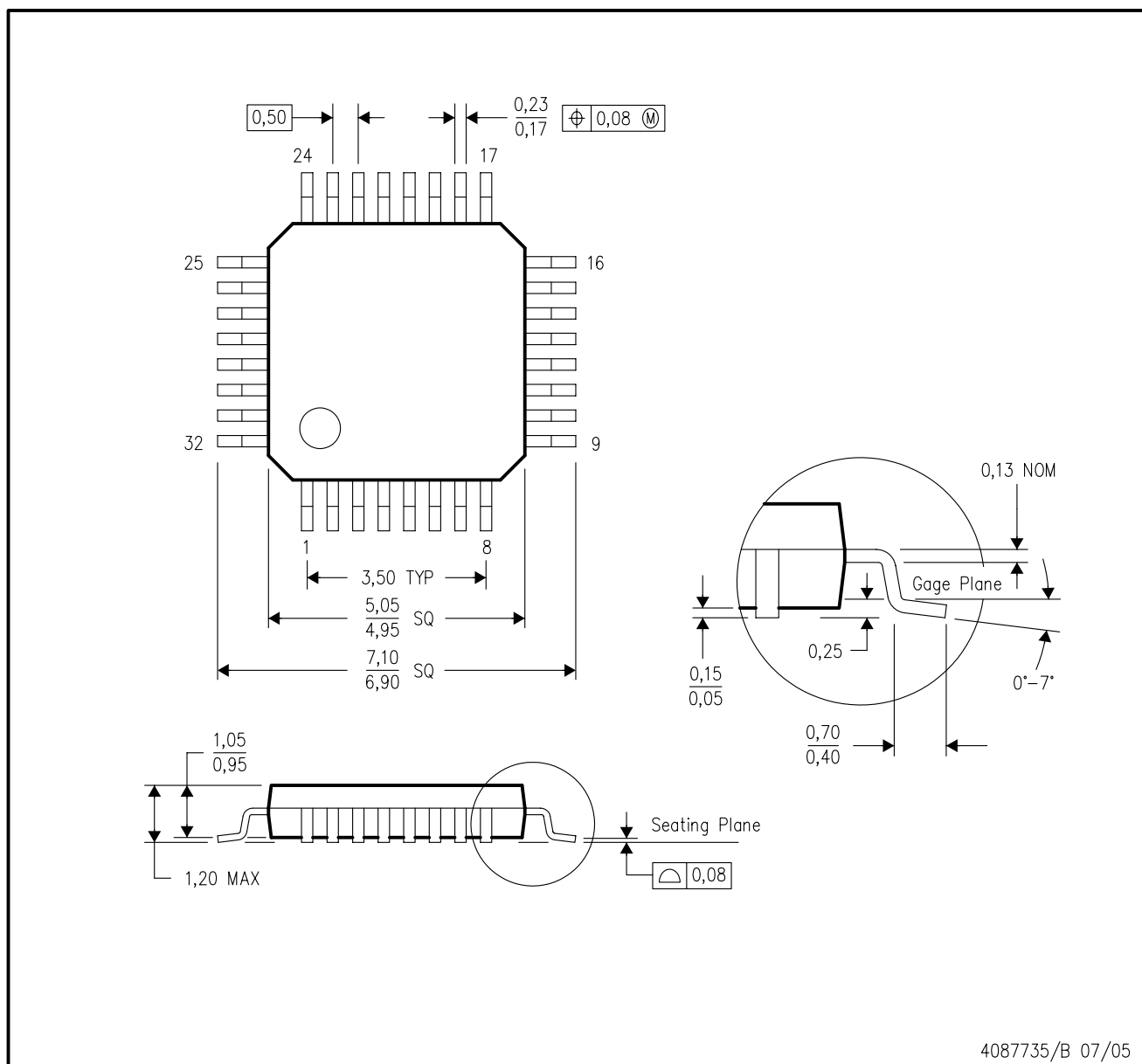

- NOTES: A. All linear dimensions are in millimeters.
B. This drawing is subject to change without notice.

PBS (S-PQFP-G32)

PLASTIC QUAD FLATPACK

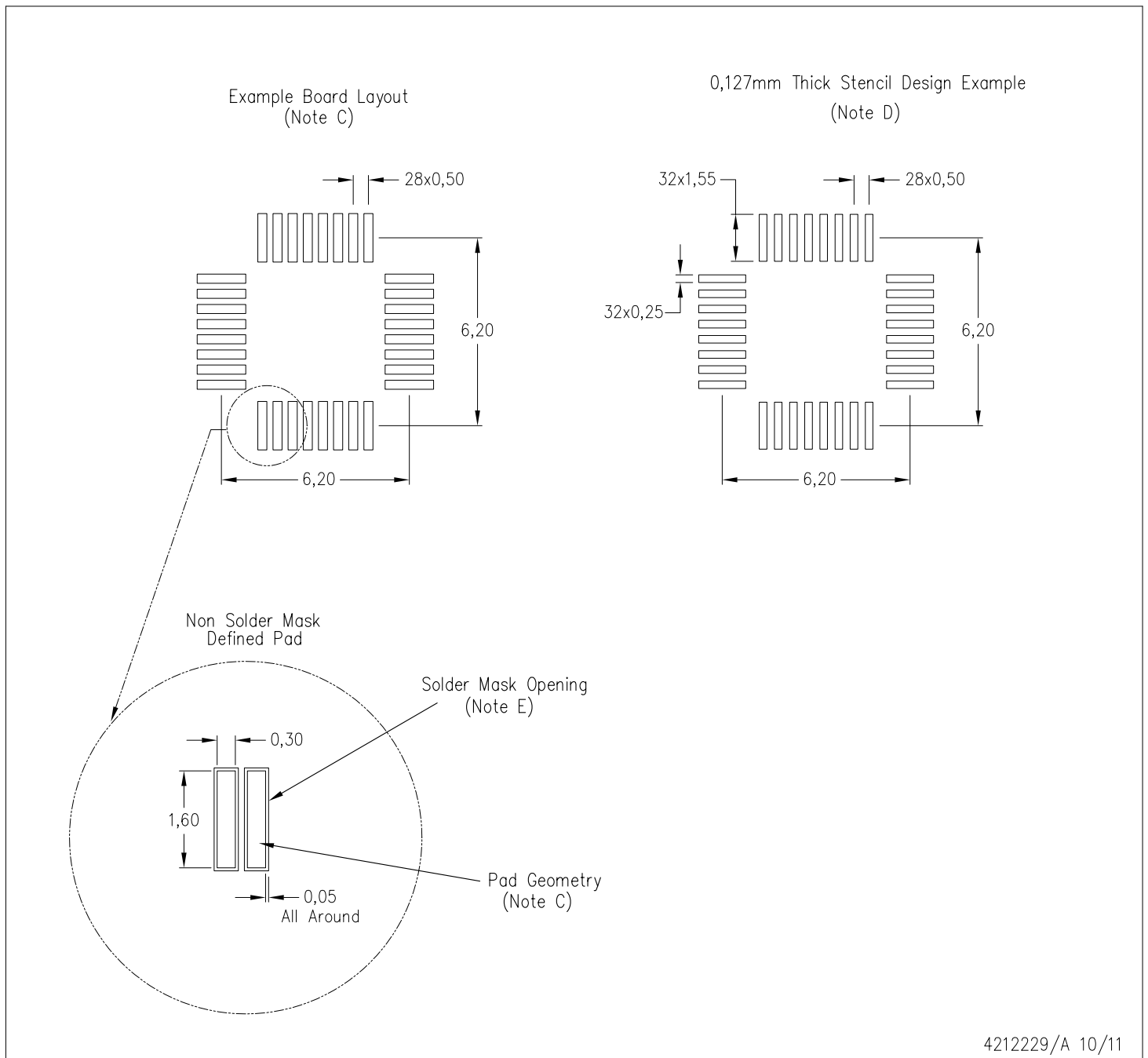

- NOTES:
- A. All linear dimensions are in millimeters.
 - B. This drawing is subject to change without notice.
 - C. Publication IPC-7351 is recommended for alternate designs.
 - D. Laser cutting apertures with trapezoidal walls and also rounding corners will offer better paste release. Customers should contact their board assembly site for stencil design recommendations. Refer to IPC 7525 for stencil design considerations.
 - E. Customers should contact their board fabrication site for recommended solder mask tolerances between and around signal pads.

IMPORTANT NOTICE

Texas Instruments Incorporated and its subsidiaries (TI) reserve the right to make corrections, enhancements, improvements and other changes to its semiconductor products and services per JESD46C and to discontinue any product or service per JESD48B. Buyers should obtain the latest relevant information before placing orders and should verify that such information is current and complete. All semiconductor products (also referred to herein as "components") are sold subject to TI's terms and conditions of sale supplied at the time of order acknowledgment.

TI warrants performance of its components to the specifications applicable at the time of sale, in accordance with the warranty in TI's terms and conditions of sale of semiconductor products. Testing and other quality control techniques are used to the extent TI deems necessary to support this warranty. Except where mandated by applicable law, testing of all parameters of each component is not necessarily performed.

TI assumes no liability for applications assistance or the design of Buyers' products. Buyers are responsible for their products and applications using TI components. To minimize the risks associated with Buyers' products and applications, Buyers should provide adequate design and operating safeguards.

TI does not warrant or represent that any license, either express or implied, is granted under any patent right, copyright, mask work right, or other intellectual property right relating to any combination, machine, or process in which TI components or services are used. Information published by TI regarding third-party products or services does not constitute a license to use such products or services or a warranty or endorsement thereof. Use of such information may require a license from a third party under the patents or other intellectual property of the third party, or a license from TI under the patents or other intellectual property of TI.

Reproduction of significant portions of TI information in TI data books or data sheets is permissible only if reproduction is without alteration and is accompanied by all associated warranties, conditions, limitations, and notices. TI is not responsible or liable for such altered documentation. Information of third parties may be subject to additional restrictions.

Resale of TI components or services with statements different from or beyond the parameters stated by TI for that component or service voids all express and any implied warranties for the associated TI component or service and is an unfair and deceptive business practice. TI is not responsible or liable for any such statements.

Buyer acknowledges and agrees that it is solely responsible for compliance with all legal, regulatory and safety-related requirements concerning its products, and any use of TI components in its applications, notwithstanding any applications-related information or support that may be provided by TI. Buyer represents and agrees that it has all the necessary expertise to create and implement safeguards which anticipate dangerous consequences of failures, monitor failures and their consequences, lessen the likelihood of failures that might cause harm and take appropriate remedial actions. Buyer will fully indemnify TI and its representatives against any damages arising out of the use of any TI components in safety-critical applications.

In some cases, TI components may be promoted specifically to facilitate safety-related applications. With such components, TI's goal is to help enable customers to design and create their own end-product solutions that meet applicable functional safety standards and requirements. Nonetheless, such components are subject to these terms.

No TI components are authorized for use in FDA Class III (or similar life-critical medical equipment) unless authorized officers of the parties have executed a special agreement specifically governing such use.

Only those TI components which TI has specifically designated as military grade or "enhanced plastic" are designed and intended for use in military/aerospace applications or environments. Buyer acknowledges and agrees that any military or aerospace use of TI components which have **not** been so designated is solely at the Buyer's risk, and that Buyer is solely responsible for compliance with all legal and regulatory requirements in connection with such use.

TI has specifically designated certain components which meet ISO/TS16949 requirements, mainly for automotive use. Components which have not been so designated are neither designed nor intended for automotive use; and TI will not be responsible for any failure of such components to meet such requirements.

Products

Audio	www.ti.com/audio
Amplifiers	amplifier.ti.com
Data Converters	dataconverter.ti.com
DLP® Products	www.dlp.com
DSP	dsp.ti.com
Clocks and Timers	www.ti.com/clocks
Interface	interface.ti.com
Logic	logic.ti.com
Power Mgmt	power.ti.com
Microcontrollers	microcontroller.ti.com
RFID	www.ti-rfid.com
OMAP Mobile Processors	www.ti.com/omap
Wireless Connectivity	www.ti.com/wirelessconnectivity

Applications

Automotive and Transportation	www.ti.com/automotive
Communications and Telecom	www.ti.com/communications
Computers and Peripherals	www.ti.com/computers
Consumer Electronics	www.ti.com/consumer-apps
Energy and Lighting	www.ti.com/energy
Industrial	www.ti.com/industrial
Medical	www.ti.com/medical
Security	www.ti.com/security
Space, Avionics and Defense	www.ti.com/space-avionics-defense
Video and Imaging	www.ti.com/video

TI E2E Community e2e.ti.com