

HF **RoHS**

1.5KE Series

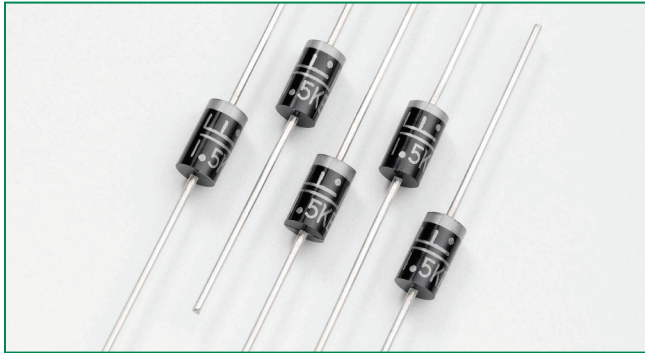

Agency Approvals

AGENCY	AGENCY FILE NUMBER
	E128662/E230531

Maximum Ratings and Thermal Characteristics (T_A = 25°C unless otherwise noted)

Parameter	Symbol	Value	Unit
Peak Pulse Power Dissipation by 10x1000µs test waveform (Fig.1) (Note 1)	P _{PPM}	1500	W
Steady State Power Dissipation on infinite heat sink at T _L = 75°C (Fig. 5)	P _D	6.5	W
Peak Forward Surge Current, 8.3ms Single Half Sine Wave Unidirectional only (Note 2)	I _{FSM}	200	A
Maximum Instantaneous Forward Voltage at 100A for Unidirectional only (Note 3)	V _F	3.5/5.0	V
Operating Junction and Storage Temperature Range	T _J , T _{STG}	-55 to 175	°C
Typical Thermal Resistance Junction to Lead	R _{θJL}	15	°C/W
Typical Thermal Resistance Junction to Ambient	R _{θJA}	75	°C/W

Notes:

1. Non-repetitive current pulse, per Fig. 3 and derated above T_A = 25°C per Fig. 2.
2. Measured on 8.3ms single half sine wave or equivalent square wave, duty cycle=4 per minute maximum.
3. V_F < 3.5V for devices of V_{BR} ≤ 200V and V_F < 5.0V for devices of V_{BR} ≥ 201V.

Description

The 1.5KE Series is designed specifically to protect sensitive electronic equipment from voltage transients induced by lightning and other transient voltage events.

Features

- Halogen-Free
- RoHS compliant
- Typical maximum temperature coefficient
 $\Delta V_{BR} = 0.1\% \times V_{BR} @ 25^\circ\text{C} \times \Delta T$
- Glass passivated chip junction in DO-201 Package
- 1500W peak pulse capability at 10x1000µs waveform, repetition rate (duty cycles): 0.01%
- Fast response time: typically less than 1.0ps from 0 Volts to BV min
- Excellent clamping capability
- Low incremental surge resistance
- Typical I_R less than 1µA above 13V
- High temperature soldering guaranteed: 260°C/40 seconds / 0.375"(9.5mm) lead length, 5 lbs., (2.3kg) tension
- Plastic package has Underwriters Laboratory Flammability classification 94V-0
- Matte Tin Lead-free plated

Applications

TVS devices are ideal for the protection of I/O interfaces, V_{CC} bus and other vulnerable circuits used in telecom, computer, industrial and consumer electronic applications.

SMAJ Series

Electrical Characteristics

Part Number (Uni)	Part Number (Bi)	Reverse Stand off Voltage V_R (Volts)	Breakdown Voltage V_{BR} (Volts) @ I_T		Test Current I_T (mA)	Maximum Clamping Voltage V_C @ I_{PP} (Volts)	Maximum Peak Pulse Current I_{PP} (A)	Maximum Reverse Leakage I_R @ V_R (μ A)	Agency Approval 
			MIN	MAX					
1.5KE6.8A	1.5KE6.8CA	5.80	6.45	7.14	10	10.5	144.8	1000	X
1.5KE7.5A	1.5KE7.5CA	6.40	7.13	7.88	10	11.3	134.5	500	X
1.5KE8.2A	1.5KE8.2CA	7.02	7.79	8.61	10	12.1	125.6	200	X
1.5KE9.1A	1.5KE9.1CA	7.78	8.65	9.50	1	13.4	113.4	50	X
1.5KE10A	1.5KE10CA	8.55	9.50	10.50	1	14.5	104.8	10	X
1.5KE11A	1.5KE11CA	9.40	10.50	11.60	1	15.6	97.4	5	X
1.5KE12A	1.5KE12CA	10.20	11.40	12.60	1	16.7	91.0	5	X
1.5KE13A	1.5KE13CA	11.10	12.40	13.70	1	18.2	83.5	1	X
1.5KE15A	1.5KE15CA	12.80	14.30	15.80	1	21.2	71.7	1	X
1.5KE16A	1.5KE16CA	13.60	15.20	16.80	1	22.5	67.6	1	X
1.5KE18A	1.5KE18CA	15.30	17.10	18.90	1	25.2	60.3	1	X
1.5KE20A	1.5KE20CA	17.10	19.00	21.00	1	27.7	54.9	1	X
1.5KE22A	1.5KE22CA	18.80	20.90	23.10	1	30.6	49.7	1	X
1.5KE24A	1.5KE24CA	20.50	22.80	25.20	1	33.2	45.8	1	X
1.5KE27A	1.5KE27CA	23.10	25.70	28.40	1	37.5	40.5	1	X
1.5KE30A	1.5KE30CA	25.60	28.50	31.50	1	41.4	36.7	1	X
1.5KE33A	1.5KE33CA	28.20	31.40	34.70	1	45.7	33.3	1	X
1.5KE36A	1.5KE36CA	30.80	34.20	37.80	1	49.9	30.5	1	X
1.5KE39A	1.5KE39CA	33.30	37.10	41.00	1	53.9	28.2	1	X
1.5KE43A	1.5KE43CA	36.80	40.90	45.20	1	59.3	25.6	1	X
1.5KE47A	1.5KE47CA	40.20	44.70	49.40	1	64.8	23.5	1	X
1.5KE51A	1.5KE51CA	43.60	48.50	53.60	1	70.1	21.7	1	X
1.5KE56A	1.5KE56CA	47.80	53.20	58.80	1	77.0	19.7	1	X
1.5KE62A	1.5KE62CA	53.00	58.90	65.10	1	85.0	17.9	1	X
1.5KE68A	1.5KE68CA	58.10	64.60	71.40	1	92.0	16.5	1	X
1.5KE75A	1.5KE75CA	64.10	71.30	78.80	1	103.0	14.8	1	X
1.5KE82A	1.5KE82CA	70.10	77.90	86.10	1	113.0	13.5	1	X
1.5KE91A	1.5KE91CA	77.80	86.50	95.50	1	125.0	12.2	1	X
1.5KE100A	1.5KE100CA	85.50	95.00	105.00	1	137.0	11.1	1	X
1.5KE110A	1.5KE110CA	94.00	105.00	116.00	1	152.0	10.0	1	X
1.5KE120A	1.5KE120CA	102.00	114.00	126.00	1	165.0	9.2	1	X
1.5KE130A	1.5KE130CA	111.00	124.00	137.00	1	179.0	8.5	1	X
1.5KE150A	1.5KE150CA	128.00	143.00	158.00	1	207.0	7.3	1	X
1.5KE160A	1.5KE160CA	136.00	152.00	168.00	1	219.0	6.9	1	X
1.5KE170A	1.5KE170CA	145.00	162.00	179.00	1	234.0	6.5	1	X
1.5KE180A	1.5KE180CA	154.00	171.00	189.00	1	246.0	6.2	1	X
1.5KE200A	1.5KE200CA	171.00	190.00	210.00	1	274.0	5.5	1	X
1.5KE220A	1.5KE220CA	185.00	209.00	231.00	1	328.0	4.6	1	X
1.5KE250A	1.5KE250CA	214.00	237.00	263.00	1	344.0	4.4	1	X
1.5KE300A	1.5KE300CA	256.00	285.00	315.00	1	414.0	3.7	1	X
1.5KE350A	1.5KE350CA	300.00	332.00	368.00	1	482.0	3.2	1	X
1.5KE400A	1.5KE400CA	342.00	380.00	420.00	1	548.0	2.8	1	X
1.5KE440A	1.5KE440CA	376.00	418.00	462.00	1	602.0	2.5	1	X
1.5KE480A	1.5KE480CA	408.00	456.00	504.00	1	658.0	2.3	1	X
1.5KE510A	1.5KE510CA	434.00	485.00	535.00	1	698.0	2.1	1	X
1.5KE530A	1.5KE530CA	477.00	503.50	556.50	1	725.0	2.1	1	X
1.5KE540A	1.5KE540CA	486.00	513.00	567.00	1	740.0	2.0	1	X
1.5KE550A	1.5KE550CA	495.00	522.50	577.50	1	760.0	2.0	1	X
1.5KE600A	1.5KE600CA	512.00	570.00	630.00	1	828.0	1.8	1	X

For bidirectional type having V_R of 10 volts and less, the I_R limit is double.

For parts without A, the V_{BR} is $\pm 10\%$ and V_C is 5% higher than with A parts.

Ratings and Characteristic Curves ($T_A=25^\circ\text{C}$ unless otherwise noted)

Figure 1 - Peak Pulse Power Rating Curve

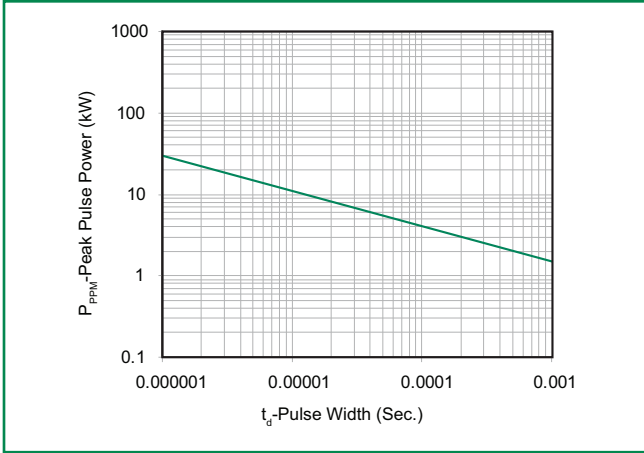

Figure 2 - Pulse Derating Curve

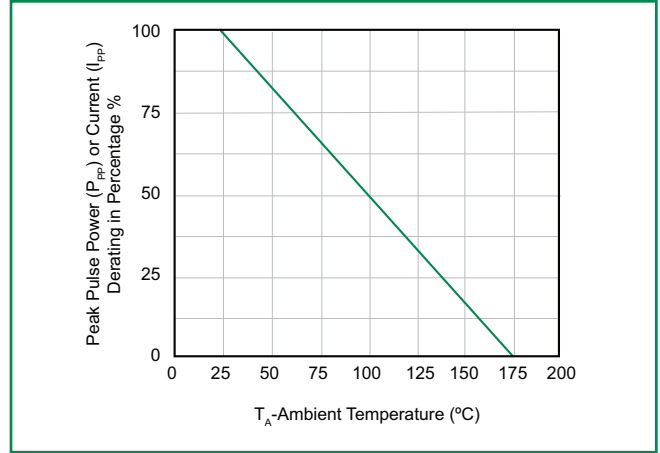

Figure 3 - Pulse Waveform

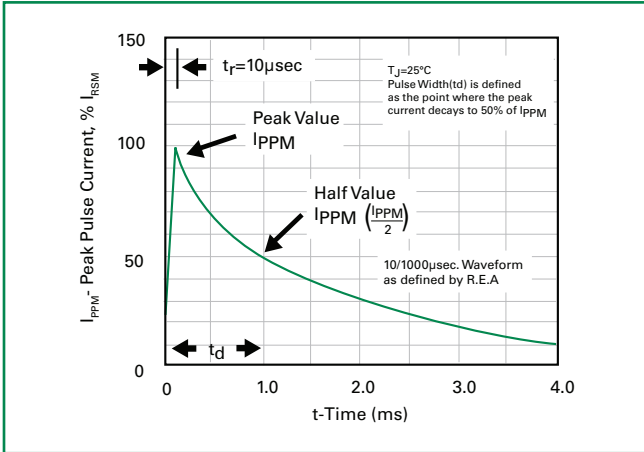

Figure 4 - Typical Junction Capacitance

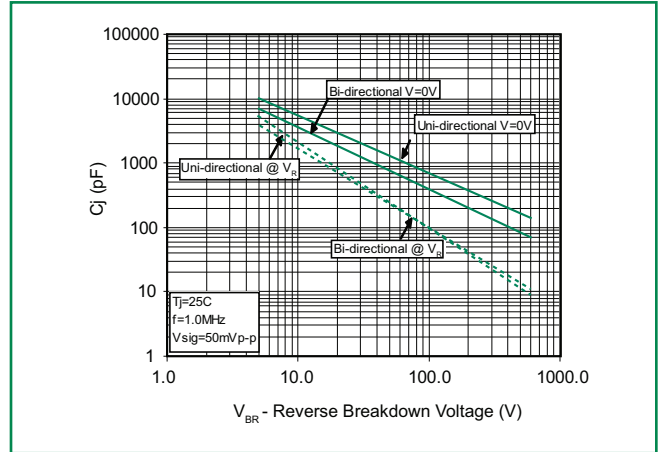

Figure 5 - Steady State Power Derating Curve

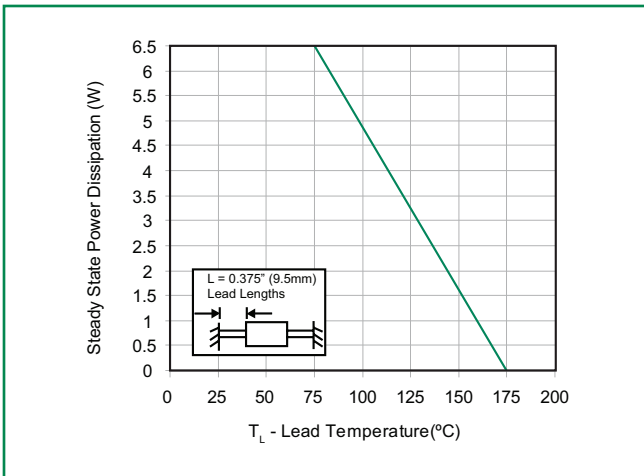
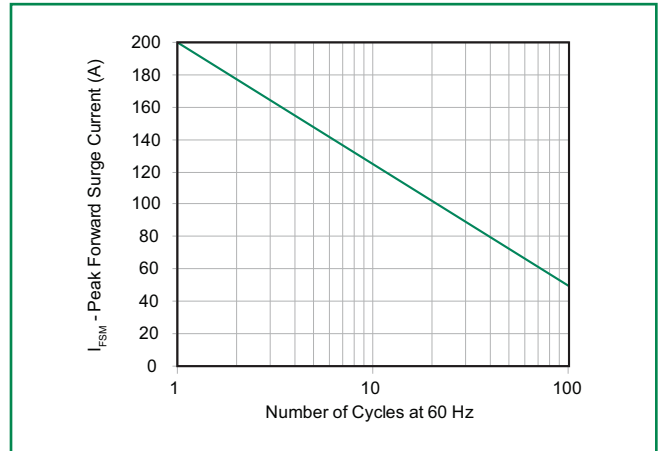
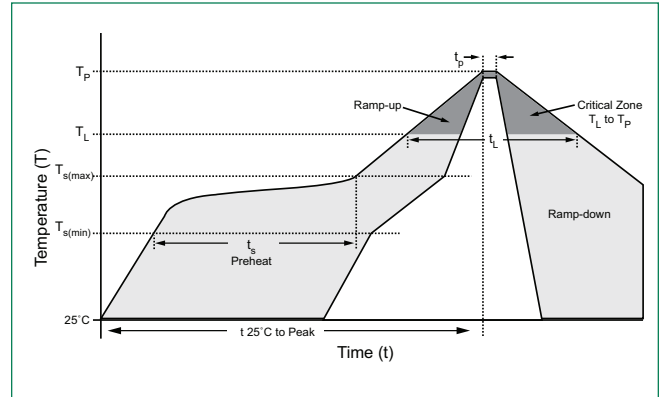

Figure 6 - Maximum Non-Repetitive Peak Forward Surge Current Uni-Directional Only



Soldering Parameters

Reflow Condition		Lead-free assembly
Pre Heat	- Temperature Min ($T_{s(min)}$)	150°C
	- Temperature Max ($T_{s(max)}$)	200°C
	- Time (min to max) (t_s)	60 – 180 secs
Average ramp up rate (Liquidus Temp (T_L) to peak)		3°C/second max
$T_{s(max)}$ to T_L - Ramp-up Rate		3°C/second max
Reflow	- Temperature (T_L) (Liquidus)	217°C
	- Time (min to max) (t_s)	60 – 150 seconds
Peak Temperature (T_p)		260 ^{+0/-5} °C
Time within 5°C of actual peak Temperature (t_p)		20 – 40 seconds
Ramp-down Rate		6°C/second max
Time 25°C to peak Temperature (T_p)		8 minutes Max.
Do not exceed		280°C



Flow/Wave Soldering (Solder Dipping)

Peak Temperature :	265°C
Dipping Time :	10 seconds
Soldering :	1 time

Physical Specifications

Weight	0.045oz., 1.2g
Case	JEDEC DO-201 molded plastic body over passivated junction.
Polarity	Color band denotes the cathode except Bipolar.
Terminal	Matte Tin axial leads, solderable per JESD22-B102D.

Environmental Specifications

Temperature Cycle	JESD22-A104
Pressure Cooker	JESD 22-A102
High Temp. Storage	JESD22-A103
HTRB	JESD22-A108
Thermal Shock	JESD22-A106

Dimensions

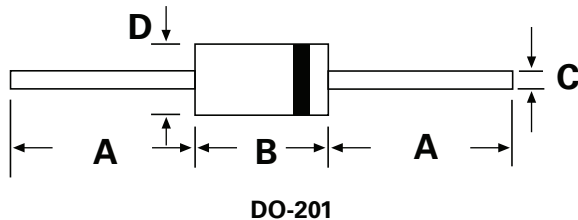

Dimensions	Inches		Millimeters	
	Min	Max	Min	Max
A	1.000	-	25.40	-
B	0.285	0.375	7.20	9.50
C	0.038	0.042	0.96	1.07
D	0.190	0.210	4.80	5.30

Part Numbering System

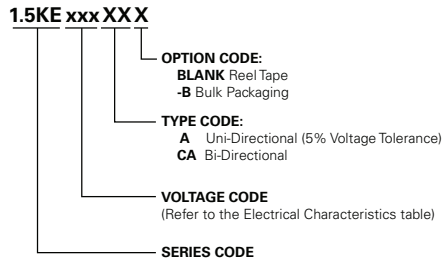

Part Marking System

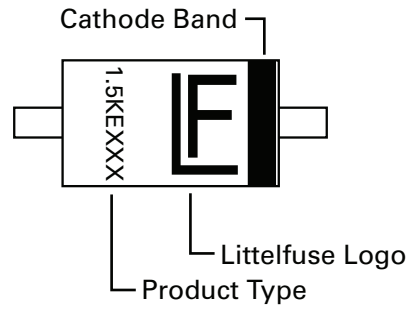

Packaging

Part Number	Component Package	Quantity	Packaging Option	Packaging Specification
1.5KExxxXX	DO-201	1200	Tape & Reel	EIA STD RS-296E
1.5KExxxXX-B	DO-201	500	BULK	Littelfuse Concord Packing Spec. DM-0016